



WOFI®

*leben mit
licht*

...lights for living

2015

The logo consists of the word "WOFI" in a bold, black, sans-serif font. The letter "O" is replaced by a white circle with a red dot in the center, resembling an eye or a stylized light source. A registered trademark symbol (®) is located to the upper right of the "I".

WOFI[®]

*leben mit
licht*

...lights for living

Schon immer war der Mensch von Licht fasziniert. Licht bringt mehr Wohnlichkeit. Licht schafft ein besonderes Ambiente. Licht setzt individuelle Akzente.

Seit über 50 Jahren entwickelt WOFI Leuchten, die zum Lebensstil passen. Seitdem setzen wir Maßstäbe in der Produktentwicklung. Wir verwandeln aktuelle Trends in ansprechendes Design und neueste Technologie in nachhaltige Effizienz.

Innovationen stehen bei uns im Vordergrund. Das beweisen wir mit jedem der rund 400 Produkte, die wir jährlich neu entwickeln und vermarkten. Und unser dynamisches Wachstum in den letzten fünf Jahrzehnten gibt uns Recht. Doch unser Erfolg ist noch lange kein Grund, sich darauf auszuruhen. Deshalb sammeln wir stets neue Ideen, Erfahrungen und Erkenntnisse und bewerten die Impulse aus dem Markt, um sie in unsere zukunftsweisenden Neuentwicklungen einfließen zu lassen. Das Ergebnis ist in der Branche richtungsweisend.

Jedes Jahr aufs Neue ist es daher für uns Verpflichtung und Antrieb zugleich, Ihnen ein bedarfsgerechtes, klar gegliedertes Sortiment zu bieten, das sowohl qualitativ als auch preislich überzeugt. Kombiniert mit unserem exzellenten Service sind wir genau das, was der filialisierte Einzel- und Fachhandel von einem der führenden Anbieter auf dem europäischen Markt erwarten darf: der zuverlässige Lichtpartner mit Erfolgsgarantie.

Man has always been fascinated by light. Light adds comfort. Light creates a special ambience. Light sets individual accents.

Over fifty years ago, WOFI began developing lamps to match lifestyle. Ever since, we have been setting the standards of product development. We turn current trends into attractive designs and the latest technology into sustainable efficiency.

We are focused on innovation which we prove by developing and marketing 400 new products every year. And the growth we have experienced in the last five decades has proven us right. Yet our success is no reason for complacency. So we constantly look for new ideas, influences and insights and assess market developments so we can channel them into trend setting new product designs. Our results lead the entire industry.

Year after year, this drives our motivation and our commitment to offer a well-structured product range that combines superior quality with attractive pricing. Add our excellent service, and WOFI is just what retail chain stores and specialty retailers should be able to expect from one of Europe's leading lighting manufacturers: a reliable partner that guarantees success.

Qualität von Anfang an

Wir entwickeln unsere Produkte für die Ewigkeit!

Anfangen von der Idee für ein neues Produkt in Zusammenarbeit mit unseren Kunden und renommierten Designern über die Produktionsbegleitung und Beschaffung im In- und Ausland bis hin zur zielgerichteten Vermarktung über ein professionelles Key-Account-Management kombiniert mit modernsten Marketinginstrumenten, obliegt es unserem Licht-Kompetenzzentrum in Meschede-Freienohl die WOFI Erfolgsstory fortzuschreiben. Begleitet wird dieser Prozess durch eines der modernsten Logistikzentren der Branche, das einen hohen Servicegrad garantiert.

Nehmen Sie uns beim Wort!



Quality right from the start

Designing for eternity

The task of ensuring WOFI's continuing success is in the capable hands of the company's lighting competence centre in Meschede-Freienohl. The centre is responsible for developing new product ideas in collaboration with our customers and famous designers. It also oversees the production stage, including the purchasing of materials from Germany and abroad, and the targeted marketing of finished products under the professional guidance of our key account managers using the latest sales tools.

To ensure the smooth running of the entire process and guarantee excellent customer support, WOFI has established one of the most modern logistics centres in the industry.

A name you can trust!



Lumen ist das neue Watt!

Aufgrund europäischer Richtlinien verschwindet die klassische Glühlampe vom Markt.

Eine große Produktvielfalt an Lampen mit unterschiedlichen Energieeffizienzen befindet sich zur Zeit auf dem Markt. Dieses Produktspektrum reicht von unzähligen Variationen und Lampenbauformen, je nach Hersteller und Verwendungszweck (Energiesparlampen, ECO Halogenlampen, LED).

Bei dieser Produktrange verliert die bekannte Vergleichsgröße WATT immer mehr an Bedeutung. Wie viel Helligkeit eine Lampe produziert, verrät sie nicht, sie sagt uns nur etwas über den Energieverbrauch. Um die unterschiedlichen Lampen bezüglich ihrer Energieeffizienz in punkto Lichtleistung besser vergleichen zu können, kommt die aussagekräftige Einheit LUMEN (lm) hinzu.

Der angegebene Wert Lumen/Watt (lm/W) bezieht sich immer nur auf eine Lichtquelle. Um den gesamten Lichtstrom der Leuchte zu ermitteln, ist der Wert mit der Anzahl der Lichtquellen zu multiplizieren.

Beispiel:



Lumen are the new watts!

Due to European energy efficiency guidelines, traditional incandescent light bulbs will disappear from the market.

Right now, consumers can choose from a wide range of lights with different efficiency ratings. Depending on the manufacturer and use, the spectrum of available products includes countless variations and construction types: compact fluorescent lamps, ECO halogen lights and LED lights. This wide range means that the unit of measurement WATTS continually loses importance as a means of comparing lights. It only tells us how much power a light consumes – and nothing about the amount of light it produces.

In order to help consumers compare the energy efficiency and light output of lamps, we are now also using the unit of measurement lumen (lm).

Example: The indicated value of Lumen/Watt (lm/W) always refers to one light source. In order to calculate the total lighting current please multiply the value with the available light sources.



Alles aus einer Hand:

Von der ersten Idee bis zur fertigen Leuchte.

WOFI – immer mit leuchtendem Beispiel voran.

Damit unsere Leuchten in Ihrem Fachgeschäft gut ankommen, legen wir bei WOFI sehr großen Wert auf hohe Qualität. Um diese zu garantieren, sorgen wir in unserem Licht-Kompetenzzentrum in Meschede-Freienohl dafür, dass unsere Spezialisten aus allen Disziplinen Hand in Hand arbeiten – Design, Konstruktion, Einkauf, Produktion, Marketing und Vertrieb. Nur so können wir zu jeder Phase der Produktentwicklung unsere Kompetenzen bündeln, unser Know-how nutzen und unsere Visionen verwirklichen.

1 *Konstruktion* ...Drafting

Jetzt wird es Ernst: Unsere Designer und Ingenieure legen alle Details fest und bestimmen die Technologien.

Time to get serious: our designers and engineers work out every detail and determine which types of technology to use.



2 *Musterbau* ...Prototype Building

Hier wird aus der Theorie endlich Praxis: Was bisher nur virtuell war, ist zum ersten Mal 'anfassbar'. Dank der virtuellen Fertigkeiten unserer Maschinenschlosser, CNC-Fräser, Musterbauer und Feinblechner.

Theory turns into reality: a virtual design finally becomes tangible – thanks to the advanced skills of our machinists, CNC mill operators, prototype builders and sheet metal workers.

7 *Service* ...Service

Mit der Lieferung ist unser Service noch lange nicht vorbei: Die Mitarbeiter unserer Serviceabteilung kümmern sich um allgemeine und technische Fragen. Helfen bei Problemen oder Ersatzteilen. Und sind telefonisch oder per Internet für Sie da.

Our commitment doesn't end when we deliver your order: Our service department associates can answer general and technical questions, help with problems and ship spare parts – on the phone or on the internet.



We do it all:

From drawing the first sketch to producing the final product.

WOFI – a shining example.

We want to ensure our lamps are well received in your shop. So WOFI controls the development and production process from start to finish. After all, we feel there's only one way to guarantee perfect quality in our lighting competence centre in Meschede-Freienohl: to have all of our specialists working hand in hand on all aspects of the development and production process – design, construction, sourcing, production, marketing and sales.

3 **Qualitätsmanagement** ...Quality Management

Material, Elektronik, Lebensdauer, Handling, Alltagstauglichkeit – das sind nur ein paar unserer vielen Kriterien, die unsere Qualitätsmanager sehr genau nehmen.

Material selection, electrical components, life expectancy, handling and usability – these are just a few criteria that our quality team takes very seriously.

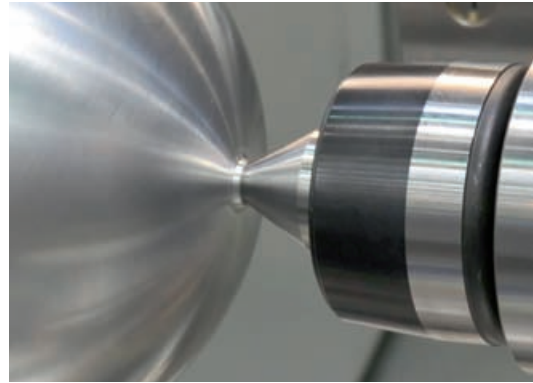

4 **Produktion** ...Production

Hat ein Produkt den Prozess bis hierhin durchlaufen und konnte unseren hohen Anforderungen standhalten, wird es produziert. Die Produktion unserer Artikel wird permanent durch unsere Inspektoren überwacht.

We'll produce a product only after it has passed all of the above steps and meets with our high standards.



6 **WOFI am POS** ...Point of Sale

Die richtigen Marketinginstrumente, ein gelungener Markenauftritt sowie moderne und vielseitig einsetzbare Vertriebskonzepte, bringen WOFI am POS zum Leuchten. Unsere Fachleute sorgen vor Ort für die Zufriedenheit Ihrer Kunden.

The appropriate marketing tools, a well-rounded brand image and our modern and multifaceted sales and distribution concepts make WOFI shine at the point of sale. Our on-site experts ensure customer satisfaction.



5 **Logistik-Zentrum** ...Distribution Centre

Eines der modernsten Logistikzentren der Branche sorgt in Zusammenarbeit mit unserem Bestandsmanager dafür, dass unsere Leuchten überall rechtzeitig und vollzählig ankommen.

Working in one of the most modern distribution centres in the business, our inventory manager ensures that our all of lamps reach their destinations right on schedule.

Technologie auf einen Blick

...Technology at a glance



Halogen technology

Die Halogenlampen haben ein brillantes Akzentlicht mit einer ausgezeichneten Lichtqualität, eine natürliche Lichtwirkung und einen perfekten Farbwiedergabe-Index von 100%. Halogenlampen überzeugen durch natürliche Ausstrahlung: vom klassischen bis hin zu warmen Licht. Mit ihrer Dimmbarkeit kommen sie als direktes Licht im Arbeitsbereich oder als indirekte Beleuchtung zum Einsatz. Halogenlampen enthalten kein Quecksilber und sind daher problemlos im Hausmüll entsorgbar.

Halogen lamps produce brilliant accent light, delivering outstanding quality, a natural light effect and a perfect colour-rendering index of 100%. Halogen lamps win consumers over with their natural presence, delivering light ranging from classic to warm. Since halogen lights are dimmable, they are used to provide direct lighting in work areas or as an indirect light source.

Halogen bulbs do not contain mercury, so they can be disposed of by placing them in the household rubbish.

Retrofit

Durch die stufenweise Abschaffung der Glühlampe wurden die LED Lampen alltagstauglich. Die LED Technologie ist ökologisch wertvoll und ermöglicht ein völlig neues Licht. Aufgrund der hohen Energieeinsparung haben LEDs einen niedrigen Stromverbrauch und somit eine enorme Einsparung gegenüber herkömmlichen Glühlampen und das bei einer deutlich längeren Lebensdauer im Vergleich zu Halogen- und Glühlampen.

Das Schöne: Auch alte Leuchten können mit LED ausgerüstet werden. Direkter Ersatz von Glüh- und Halogenlampen durch einfaches Austauschen. Alte Lampe raus, neue Lampe rein. Umrüstung, dafür steht der Begriff Retrofit.

As incandescent bulbs are being phased out, LED lights are becoming acceptable for every-day use. LED technology is environmentally responsible and helps facilitate new approaches to light.

Due to their high efficiency, LEDs use less power, resulting in enormous cost reduction as well as considerable longer life time compared to incandescent bulbs.

And here's the beauty of it: even old lights can be equipped with LEDs. Simply replace the old halogen or incandescent bulb: remove old bulb insert new bulb.

Thus the definition is Retrofit



COB / SMD

Chip on Board / Surface mounted device

Das Kürzel „COB“ steht für Chip On Board. Dieses ist eine Produktionstechnologie aus der Mikroelektronik. Bei dieser Technologie, dem Drahtbonding, werden ungehauste Halbleiter direkt auf eine hoch wärmeleitende Leiterplatte geklebt und danach mit Mikrodrähten zur Platine verbunden. Zur Kontaktierung werden Gold-Drähte im Mikrometerbereich verwendet.

Diese Technologie erlaubt höchste Leistungsdichten auf kleinsten Raum und ist damit sicherlich die effizienteste LED-Technologie mit einer wirkungsvollen Nutzlebensdauer von bis zu 35 Jahren. Beispielsweise kann ein 6 Watt LED-Chip der neuesten Generation die gleiche Lichtleistung, wie eine herkömmliche 60 Watt Glühlampe erzeugen. Das bedeutet eine Einsparung von bis zu 90%. Zusätzlich verfügte die herkömmliche Glühlampe sogar nur über eine Lebensdauer von ungefähr einem Jahr.

COB is an abbreviation for “Chip on Board” and denotes a production process developed for microelectronics. During this process, uncased semiconductors are bonded to a highly thermoconductive circuit board. This assembly is connected to the main board with microscopic wires, facilitating high power density in a minuscule space hence it definitely is the most efficient LED technology with an effective live time up to 35 years.

For instance, the newest generation LED chip of 6 Watt can produce the same light output as a conventional incandescent bulb of 60 Watt which means a saving of 90 percent. Additionally, the life time of an incandescent bulb is around one year only.

Der Begriff **surface-mounted device** (SMD, deutsch: oberflächenmontiertes Bauelement) ist ein Fachbegriff aus der Elektronik. SMD-Bauelemente haben im Gegensatz zu Bauelementen der Durchsteckmontage (englisch *Through Hole Technology*, THT), den „bedrahteten Bauelementen“, keine Drahtanschlüsse, sondern werden mittels lötfähiger Anschlussflächen direkt auf eine Leiterplatte gelötet (Flachbaugruppe). Die dazugehörige Technik ist die **Oberflächenmontage** (englisch: *surface-mounting technology*, SMT).

Surface-mount technology (SMT) is a method for producing electronic circuits in which the components are mounted or placed directly onto the surface of printed circuit boards (PCBs). An electronic device so made is called a **surface-mount device (SMD)**. Both technologies can be used on the same board for components not suited to surface mounting such as large transformers and heat-sinked power semiconductors.

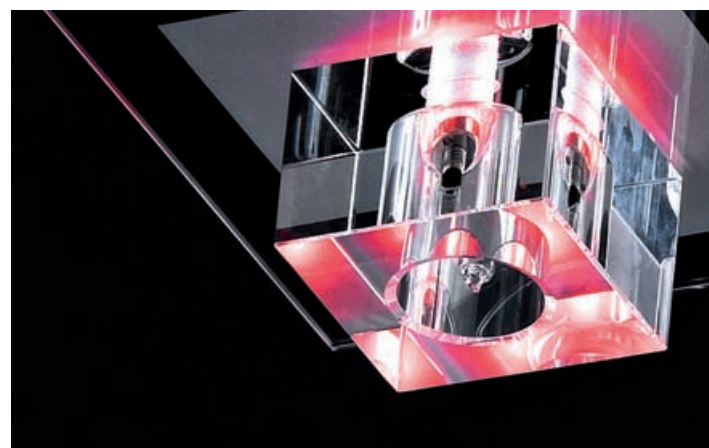

Deko LED

Deko RGB LED-Leuchten kombinieren funktionelles Licht und Farbe. Sie zaubern eine bestimmte Stimmung oder dienen als dekoratives Accessoire. Auf Knopfdruck bringt man unterschiedliche Farben in den Alltag oder setzt eindrucksvolle Akzente. Die Kombination mit energiesparenden Niedervolt-Halogenleuchten macht diese Leuchten zu einer wichtigen Ergänzung in Ihrem Sortiment. Das RGB steht für die Grundfarben Rot/Grün/Blau aus denen sich alle anderen Farben mischen lassen.

Deco-RGB-LED lights combine functional light and colour. They magically create a special atmosphere or serve as decorative accessories. At the push of a button, you can add different colour to your day or set impressive accents. What's more, the combination with energy saving low-voltage halogen lamps makes these lighting objects an important asset in your range. RGB stands for the colour red/green/blue which can be mixed into all other colors.

EU-Verordnung 874/2012

...EU-Regulations 874/2012

Energieverbrauchskennzeichnung von elektrischen Lampen und Leuchten

Diese Verordnung gilt für Leuchtmittel ab dem 01. September 2013 und für Leuchten ab dem 01. März 2014.

Energy labelling of electrical lamps and luminaires

This regulation will apply to the lamps/bulbs from 1st September 2013 and for the light fitting from 1st March 2014.

Energieeffizienzkennzeichnung

Kennzeichnung durch den einzelnen Buchstaben bedeutet die jeweilige Energieeffizienzklasse des mitgelieferten Leuchtmittels bzw. der fest verbauten LED.

Energy efficiency labelling

Individual letter stands for energy efficiency grade identification of the included bulb or mounted LED.

Beispiel / example:

1 Lenox / Serie 378
7378.04.64.0000
EAN4003474273990
Nickel-matt /
Nickel matt finished



4 x LED / 5 W incl.
3000 K / 4 x 400 lm

Energieeffizienzklasse /
energy efficiency class:



Markenleuchtmittel /
branded lamp incl.

↑ 150 cm, ↔ 80 cm

Glas: mattiert mit
Klarrand /
Glass: frosted with
clear border
Glas / Glass: 6272

Dimmbar mittels ge-
eignetem Wanddimmer /
dimmable by suitable
wall dimmer



Alle nicht auswechselbaren, fest verbauten Leuchtmittel / LEDs sind mit folgendem Piktogramm gekennzeichnet:

All not exchangeable, mounted bulbs / LED, are marked with the following picto:



Alle auswechselbaren, nicht fest verbauten Leuchtmittel können mit geeigneten Leuchtmitteln anderer Energieeffizienzklassen getauscht werden.

All exchangeable, not mounted bulbs can be replaced by suitable bulbs of different energy efficiency grade.

Folgendes Beispiel zeigt für welche Energieeffizienzklasse die jeweilige Leuchte geeignet ist sowie auch die mögliche Fassung und die maximale Watt Angabe.

The following example shows for which energy efficiency grade the lighting fixture is suitable for as well as the possible socket and the maximum wattage of each lamp.

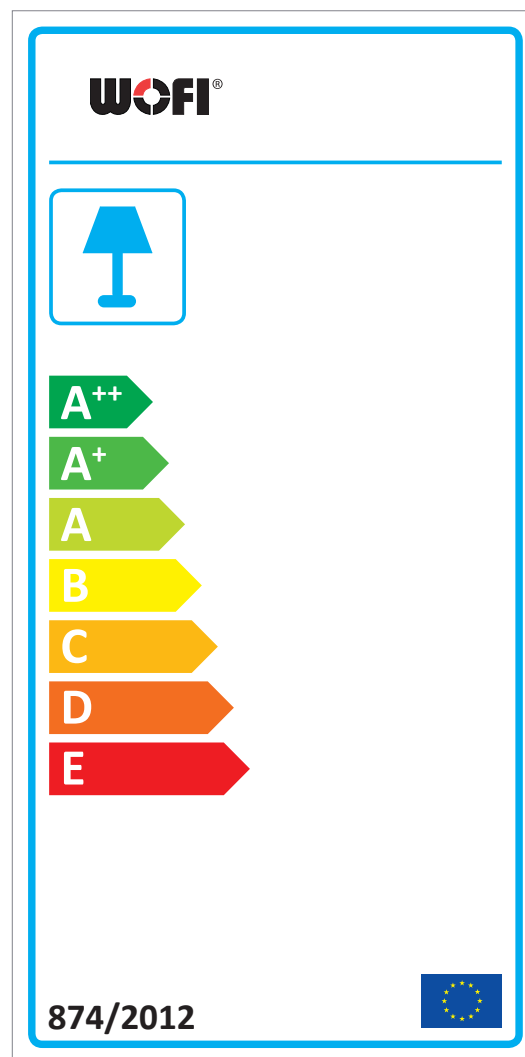

Beispiel / example:

1 Zoon / Serie 192
6192.01.01.0000
EAN4003474269436
Chrom / Chrome

geeignet für / suitable for
Energieeffizienzklasse /
energy efficiency class:



1 x E27 /
max. 60 W

Fit for LED

Ø 30 cm, ↑ 150 cm

Glas weiß mit Spiraldekor /
Glass white with spiral decoration
Glas / Glass: 6173

5 Jahre Garantie

...5 years guarantee

Für alle Produkte aus dem WOFI Sortiment, die nach dem 01.01.2013 von Verbrauchern gekauft wurden, bietet WOFI LEUCHTEN eine kostenlose, über die gesetzliche Gewährleistung von 24 Monaten hinausgehende, 5-Jahres-Garantie an.

Nähere Informationen hierzu finden Sie in der Garantieverklärung auf unserer Internetseite unter: www.wofi.de.

For all products out of the WOFI assortment, which have been bought after 01.01.2013 by the enduser, WOFI is offering a free 5-year-guarantee that exceeds the implied warranty of 24 months.

For more information please see the guarantee bond which is available on our website www.wofi.de.



Inhalt

content

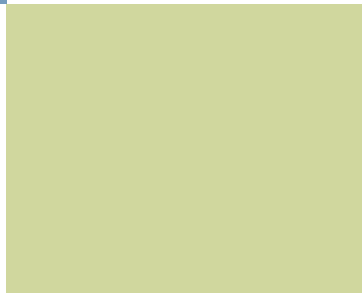
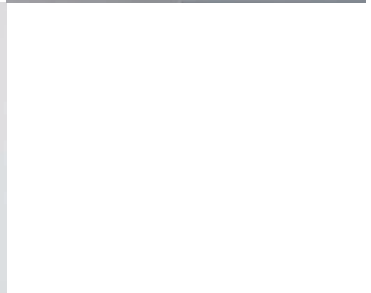
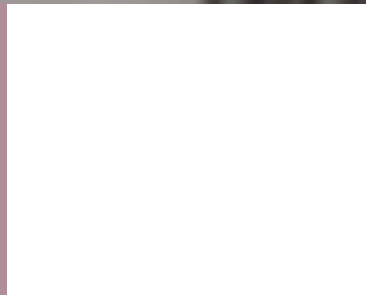

012

Produktfamilien / product families

Kristall-Leuchten

Crystal lamps

014-015 | Charme, Deluxe 018-019 | Marquis, Moulin, 020-025 | Holly
016-017 | Arizona Albero

026

Produktfamilien / product families

Modern

Modern

028-031 | Clarc 048-051 | Luz 070-071 | Lex 098-099 | Harper, Verre
032-033 | Vannes 052-053 | Nero 072-073 | Style, Laval 100-101 | Verre
034-035 | Comte 054-055 | Voss 074-075 | Cosmo 102-103 | Arc
036-037 | Colmar 056-057 | Laurids 076-077 | Avance 104-105 | Arc, Astro
038-039 | Logan, Soul 058-059 | Darwin 078-083 | Toulouse 106-107 | Astro
040-041 | Louvre 060-061 | Apart, Mercur 084-087 | Class 108-109 | Deventer
042-043 | Louvre, Avignon 062-063 | Orbit 088-089 | Georgia 110-111 | Zoon, Modena, Clara,
044-045 | Avignon 064-065 | Benett 090-093 | Casa Flame, Chateau
046-047 | Maar, Midu, 066-067 | Benett, Vela 094-095 | Troja 112-113 | Lacchino
Kent 068-069 | Crux, Xenia, Aurora

114

Höhenverstellbare Pendelleuchten

Height adjustable pendants

116-117 | Lenox, Evry 126-127 | Ava, Parker 132-133 | Savannah 140-141 | weitere höhenverstell-
118-119 | Roma, Contes 128-129 | Oklahoma, 134-135 | Sacramento bare Pendelleuchten
120-121 | Interio, Vileta Columbia, 136-137 | Augusta, Santa Fee, / additional height
122-123 | Cara, Gess Nashville Avanti adjustable pendants
124-125 | Atlanta, Talas 130-131 | Madison, Dia, 138-139 | Mali, Point
Teen

142

Stand- und Tischleuchten

Floor- and table lamps

144-145 | Caja, Trond, Fin, 150-151 | Prescott, Pop 158-159 | Quincy 165 | weitere Stand- und
Gerit, Yon 152-153 | Campus, 160-161 | Ali, Eve Tischleuchten /
146-147 | Point Liverpool, Lux 162-163 | Angers, Vant, Vitro additional floor-
148-149 | Maxime, Minster, 154-155 | Jet, Lou 164 | Skin and table lamps
Savannah, 156-157 | Twin
Bristol, Newton

166

Wand- und Deckenleuchten

Wall- and ceiling lamps

168-169 | Soul, Everett 178-179 | Lorient 188-189 | Nancy 198-199 | Luv, Kanpur, Figo
170-171 | Cholet, Chloe 180-181 | Sphinx, Leda 190-191 | Tuva, Parc, Less 200-201 | Eddy, Zibo, Buddy,
172-173 | Space, Rondo 182-183 | Jaden, Sila 192-193 | Etana Prince, Aqaba
174-175 | Reims, Lore, Mira 184-185 | Liv 194-195 | Divina, Braez 202-203 | weitere Wand- und
176-177 | Midu, Kent 186-187 | Modo, Mile 196-197 | Via, Vetro, Velo Deckenleuchten /
additional wall-
and ceiling lamps

204

Strahlerserien

Spotlight series

206-209 | Antibes 220-221 | Cameron 236-237 | Angola
210-211 | Maar 222-225 | Cara 238-239 | Angola, Marco
212-213 | Chloe 226-227 | Eve 240-241 | Micky
214-215 | Texel 228-229 | Colo, Anissa 242-243 | Sleeve-Vetro, Nixon
216-217 | Vileta 230-233 | Quincy 244-245 | Nini
218-219 | Mauro 234-235 | Nice, Noa

246

Aussenleuchten

Outdoor lamps

248-249 | Lua

250-253 | Außendienst 259-263 | General 266-269 | Index 272 | Kontakt
Sales Repre- Information Index Contact
sentatives 264 | Allgemeine Verkaufs- 270 | Serienverzeichnis
254-258 | Allgemeine bedingungen Series Index
Informationen 265 | General Terms and 271 | Farbschlüssel / Notizen
Conditions of Sale Color Key / Notes



Kristall-Leuchten

...Crystal lamps

Spiel mit Reflexionen

Ob modern, verspielt oder glamourös: Kristallleuchten sind luxuriöses Wohnelement und schöne Beleuchtung in einem. Mit unseren exklusiven Modellen haben wir den Kronleuchter von damals neu interpretiert. Damit Sie jeden Tag zauberhafte Lichtspiele genießen können.

Playing with reflections

Modern, playful or luxurious: crystal chandeliers are provide a luxurious ambience and beautiful lighting. Our exclusive models reinterpret yesterdays' chandelier so you can enjoy magical light effects every day.

Charme | 014
Deluxe | 015
Arizona | 016
Albero | 018
Marquis | 019
Moulin | 019
Holly | 020



1 Charme / Serie 760
8760.01.01.0300
EAN4003474271620
Chrom / Chrome



1 x LED / 10,8 W incl.
3000 K / 1 x 970 lm

Energieeffizienzklasse /
energy efficiency class:

A+

Markenleuchtmittel /
branded lamp incl.

Ø 32 cm, ↑ 33,5 cm



10,8W
970
Lumen

2 Charme / Serie 760
8760.01.01.0500
EAN4003474271637
Chrom / Chrome



1 x LED / 18 W incl.
3000 K / 1 x 1600 lm

Energieeffizienzklasse /
energy efficiency class:

A+

Markenleuchtmittel /
branded lamp incl.

Ø 51,5 cm, ↑ 53 cm



18W
1600
Lumen

*Glaskristalle,
die wie Diamanten
funkeln*

...Glass crystals that sparkle
like diamonds

33W

 460
 Lumen



1 Deluxe / Serie 213
 9213.05.01.0000
 EAN4003474246925
 Chrom / Chrome



5 x G9 / 33 W incl.
 2700 K / 5 x 460 lm

Energieeffizienzklasse /
 energy efficiency class:

D

Markenleuchtmittel /
 branded lamp incl.



Ø 43 cm,  13 cm

Wenn Licht Kreise zieht

...Enchanting spheres of light

Extravaganz in Bestform

Edle Glaskristallapplikationen geben der Serie DELUXE eine ganz eigene Dimension.

Extravagance in its finest form

Applications of precious glass crystals in the DELUXE series create a new dimension.



Von funkelnader Eleganz

...Sparkling elegance

Arizona / Serie 225
5225.08.01.0000
EAN4003474207117
Chrom / Chrome

geeignet für / suitable for
Energieeffizienzklasse /
energy efficiency class:



 8 x E 14 / max. 60 W

Ø 75 cm, ↓ 150 cm

Glaskristall / glass crystal
89 x Behang / 89 x strings
Glas / Glass: 7931 / 7816





7816

2 Arizona / Serie 225
5225.05.01.0000
 EAN4003474209609
 Chrom / Chrome

geeignet für / suitable for
 Energieeffizienzklasse /
 energy efficiency class:



5 x E 14 / max. 60 W

Ø 60 cm, ↓ 150 cm

Glaskristall / glass crystal
 46 x Behang / 46 x strings
 Glas / Glass: 7931 / 7816



7931 →

3 Arizona / Serie 225
4225.02.01.0000
 EAN4003474219493
 Chrom / Chrome

geeignet für / suitable for
 Energieeffizienzklasse /
 energy efficiency class:



2 x E 14 / max. 60 W

↓ 31 cm, ↔ 40 cm, ⇨ 21,5 cm

Glaskristall / glass crystal
 12 x Behang / 12 x strings
 Glas / Glass: 7931 / 7816



Ein Klassiker voller Raffinesse

Die Serie Arizona verbindet opulente Details aus Glaskristall mit modernen Lichtakzenten.

A blend of classic and modern styles

The ARIZONA series combines luxurious glass crystal details with modern light accents.

Albero / Serie 022
9022.24.01.0600
EAN4003474190457
Chrom / Chrome

24 x G4 / 12 V / 10 W incl.
2800 K / 24 x 120 lm

Energieeffizienzklasse /
energy efficiency class:

C

Markenleuchtmittel /
branded lamp incl.

↓ 45 cm, ↔ 145 cm, ↗ 80 cm

Glaskristall / glass crystal
Glas / Glass: 7662 / 7672

10W
120
Lumen

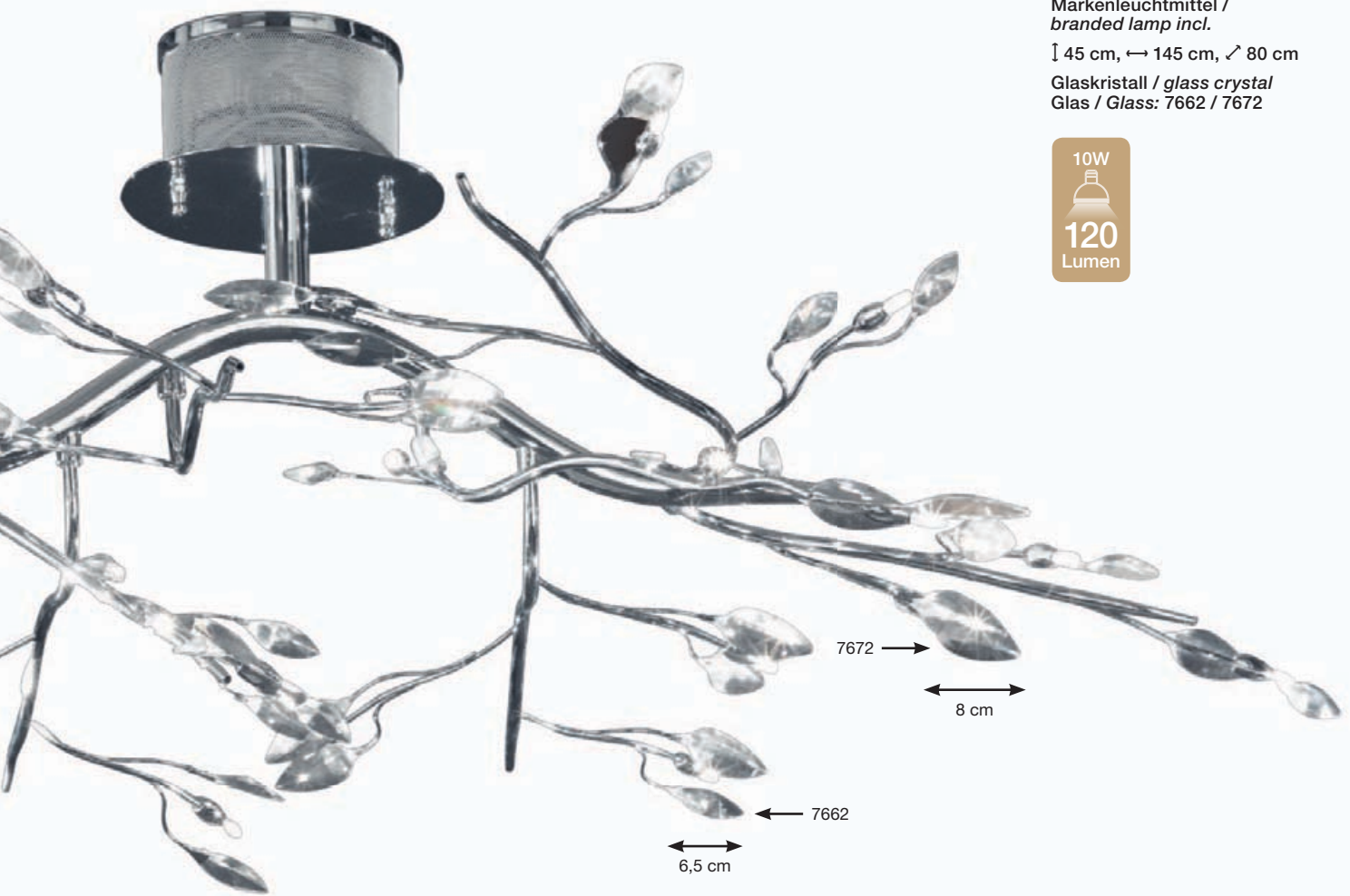

Filigran bis in die Spitzen

...Delicate right to the very tips





1 Marquis / Serie 446
9446.05.01.0000
 EAN4003474257068
 Chrom / Chrome

 5 x G4 / 12 V / 20 W incl.
 2900 K / 5 x 300 lm

Energieeffizienzklasse /
 energy efficiency class:

C

Ø 32 cm, I 44 cm

20W

300
 Lumen



2 Moulin / Serie 479
6479.06.01.0000
 EAN4003474257075
 Chrom / Chrome

 6 x G4 / 12 V / 20 W incl.
 2900 K / 6 x 300 lm

Energieeffizienzklasse /
 energy efficiency class:

C

Ø 43 cm, I 150 cm

Magische Lichtspiele

...Light effects filled with magic

Holly / Serie 568
7568.03.01.0200
EAN4003474242729
Chrom / Chrome

geeignet für / suitable for
Energieeffizienzklasse /
energy efficiency class:

A++  **E**



3 x E14 /
max. 60 W

Fit for LED

↑ 150 cm, ↔ 80 cm

Glas / Glass: 6460, Ø 17 cm





2 Holly / Serie 568
9568.01.01.0350
 EAN4003474242743
 Chrom / Chrome

geeignet für / suitable for
 Energieeffizienzklasse /
 energy efficiency class:



1 x E27 /
 max. 60 W

Fit for LED

Ø 35 cm, ↓ 24 cm



3 Holly / Serie 568
6568.01.01.0350
 EAN4003474242712
 Chrom / Chrome

geeignet für / suitable for
 Energieeffizienzklasse /
 energy efficiency class:



1 x E27 /
 max. 60 W

Fit for LED

Ø 35 cm, ↓ 150 cm

28W

370
 Lumen



4 Holly / Serie 568
8568.01.01.0130
 EAN4003474245782
 Chrom / Chrome

1 x G9 / 28 W incl.
 2800 K / 1 x 370 lm

Energieeffizienzklasse /
 energy efficiency class:



Ø 13 cm, ↓ 17 cm
 Glas / Glass: 6507,
 Ø 13 cm



Faszinierende Leichtigkeit

Glaskristalle, eingebettet in
 filigranes Design aus Chrom.

Enchanting lightness

Glass crystals embedded in
 delicately designed chrome.

Holly / Serie 568
7568.04.01.0000
EAN4003474245744
Chrom / Chrome



4 x GY6,35 / 12 V / 35 W incl.
2900 K / 4 x 580 lm

Energieeffizienzklasse /
energy efficiency class:

C

Markenleuchtmittel /
branded lamp incl.

↓ 150 cm, ↔ 75 cm

Glas / Glass: 6507, Ø 13 cm



13 cm

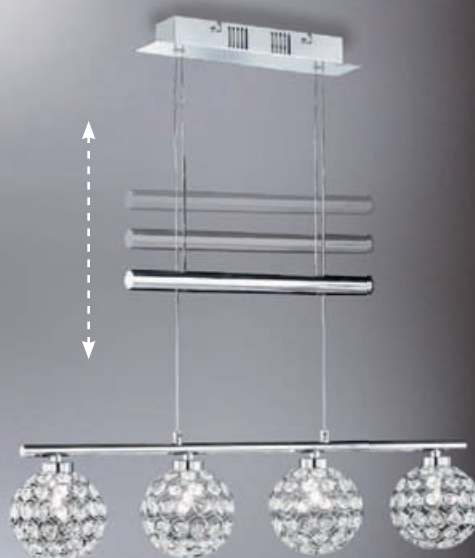

2 Holly / Serie 568
9568.06.01.0000
 EAN4003474245768
 Chrom / Chrome

HALOGEN
 EDO

↔ 120 cm, ↗ 62 cm, ↓ 35 cm
 Glas / Glass: 6507, Ø 13 cm

6 x G9 / 28 W incl.
 2800 K / 6 x 370 lm

Energieeffizienzklasse /
 energy efficiency class:

C

28W

370
 Lumen

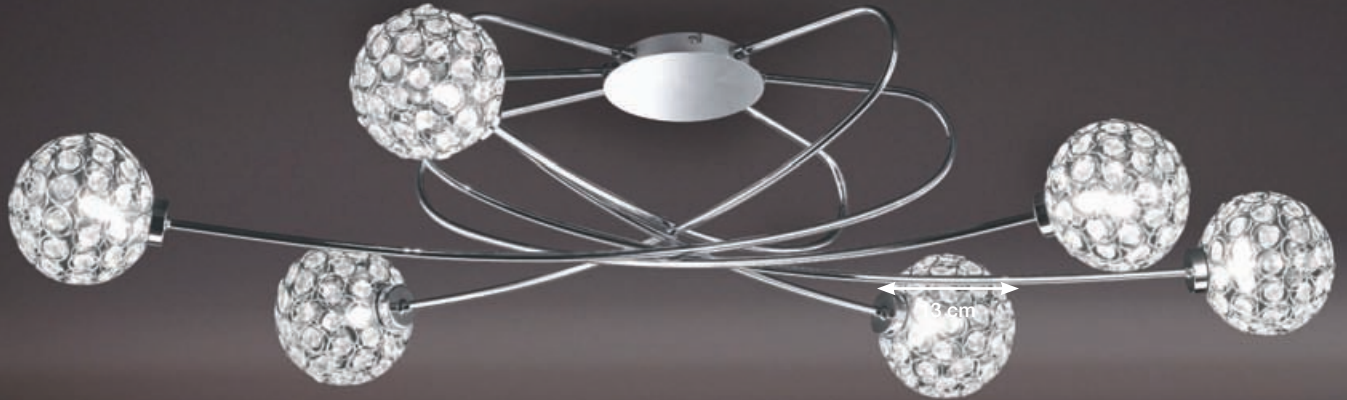

3 Holly / Serie 568
4568.01.01.0220
 EAN4003474246260
 Chrom / Chrome

geeignet für / suitable for
 Energieeffizienzklasse /
 energy efficiency class:

A++  **E**

 1 x E14 /
 max. 40 W

Fit for LED

↓ 21 cm, ↔ 22 cm,
 14,5 cm

4 Holly / Serie 568
8568.02.01.0000
 EAN4003474245720
 Chrom / Chrome

 2 x G9 / 28 W incl.
 2800 K / 2 x 370 lm

Energieeffizienzklasse /
 energy efficiency class:

C

HALOGEN
 EDO

↓ 54 cm

Glas / Glass: 6507, Ø 13 cm



Kristallene Lichtspiele

...Light effects filled with magic



Holly / Serie 568
9568.03.01.0250
EAN4003474259123
Chrom / Chrome

 3 x G9 / 28 W incl.
2800 K / 3 x 370 lm

Energieeffizienzklasse /
energy efficiency class:

C

Markenleuchtmittel /
branded lamp incl.

HALOGEN
EDV

Ø 29 cm, ↓ 15 cm

Glas / Glass: 6508, Ø 8 cm

Magische Reflektionen

Die Serie HOLLY setzt mit ungewöhnlichen Formen neue Maßstäbe bei der Interpretation von Kristall-Leuchten.

Magic reflections

With unusual shapes, the HOLLY series sets new standards for the interpretation of glass crystal lights.

2 Holly / Serie 568
3568.03.01.0000
 EAN4003474247205
 Chrom / Chrome

 3 x G9 / 28 W incl.
 2800 K / 3 x 370 lm

Energieeffizienzklasse /
 energy efficiency class:

C

HALOGEN
 EDO

↑ 154 cm, ↔ 26 cm

Glas / Glass: 6507, Ø 13 cm

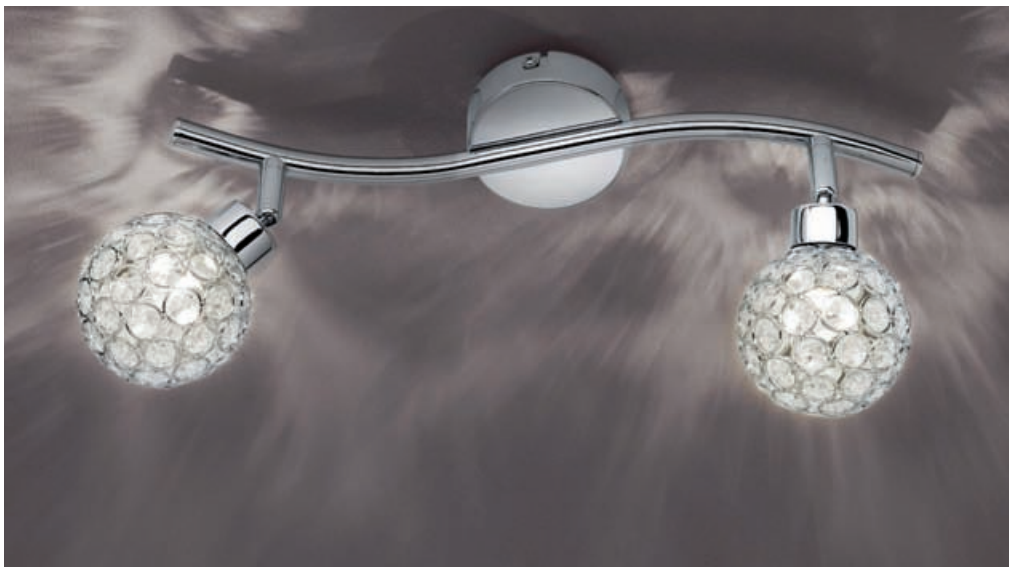
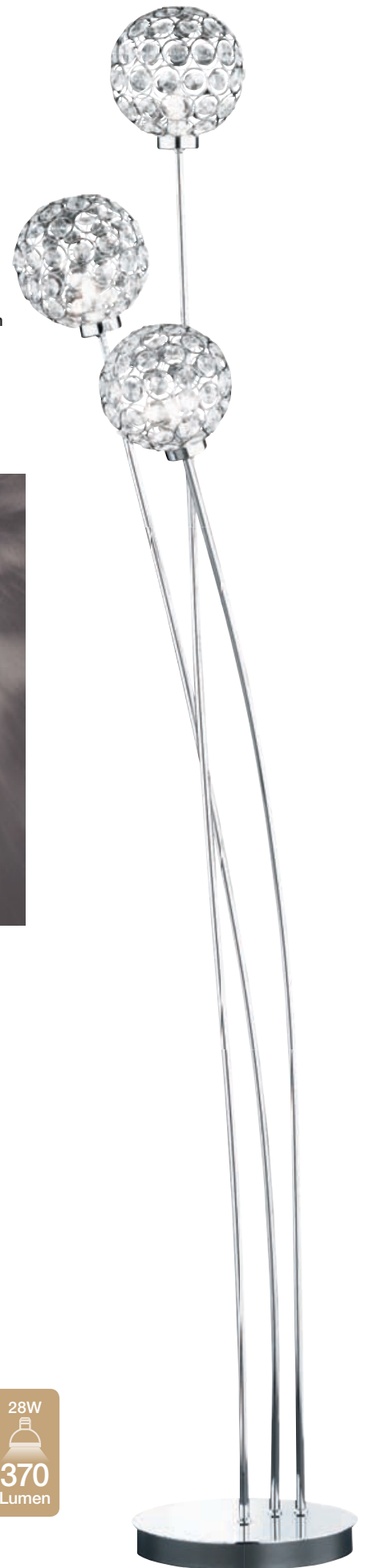

3 Holly / Serie 568
7568.02.01.1000
 EAN4003474257662
 Chrom / Chrome

 2 x G9 / 28 W incl.
 2800 K / 2 x 370 lm

Energieeffizienzklasse /
 energy efficiency class:

C

HALOGEN
 EDO

↔ 37 cm, ↓ 15 cm



4 Holly / Serie 568
4568.01.01.1000
 EAN4003474257655
 Chrom / Chrome

 1 x G9 / 28 W incl.
 2800 K / 1 x 370 lm

Energieeffizienzklasse /
 energy efficiency class:

C

HALOGEN
 EDO

↳ 15 cm, Ø 10 cm

Glas / Glass: 6508,
 Ø 8 cm

28W

370
 Lumen



Modern

...Modern

Innovationen für Morgen

Seit der Erfindung der Glühlampe hat sich viel getan. Nicht nur in der Technologie, sondern auch im Design. So hat sich manche praktische Lichtquelle inzwischen zu einem modernen Leuchtobjekt entwickelt und wird immer öfter als schöner Blickfang platziert.

Innovations for tomorrow

Much has changed since the invention of the light bulb – both in terms of technology and design. Many practical light sources have become modern lighting objects and are being used as beautiful eye catchers.

Clarc	028
Vannes	032
Comte	034
Colmar	036
Logan	038
Soul	038
Louvre	040
Avignon	043
Maar	046
Midu	046
Kent	047
Luz	048
Nero	052
Voss	054
Laurids	056
Darwin	058
Apart	060
Mercur	061
Orbit	062
Benett	064
Vela	067
Crux	068
Xenia	069
Aurora	069
Lex	070
Style	072
Laval	073
Cosmo	074
Avance	076
Toulouse	078
Class	084
Georgia	088
Casa	090
Troja	094
Sienna	096
Harper	098
Verre	099
Arc	102
Astro	105
Deventer	108
Zoon	110
Flame	110
Modena	110
Clara	110
Chateau	111
Lacchino	112

Guter Stil macht seine Runde

...Good style makes its way round



20W
1800
Lumen

1 Clarc / Serie 505
8505.01.24.0000
EAN4003474287195
Schwarz/Chrom / Black/Chrome

 1 x LED / 20 W incl.
3000 K / 1 x 1800 lm

Energieeffizienzklasse /
energy efficiency class:

A+

Markenleuchtmittel /
branded lamp incl.

Ø 35 cm, ↑ 50 cm

Glas / Glass: 1402

Dimmer Memory Funktion
Dimmer Memory Function

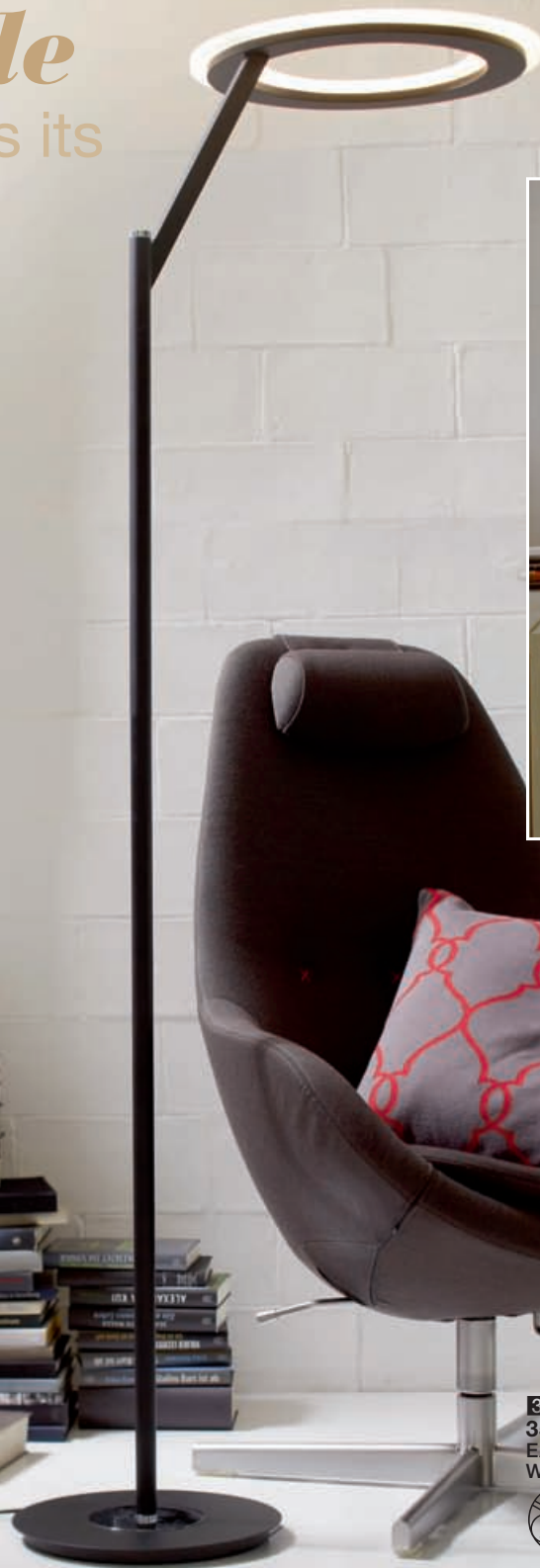

40W
3600
Lumen

2 Clarc / Serie 505
3505.01.24.0000
EAN4003474287188
Schwarz/Chrom /
Black/Chrome

 1 x LED / 40 W incl.
3000 K / 1 x 3600 lm

Energieeffizienzklasse /
energy efficiency class:

A+

Markenleuchtmittel /
branded lamp incl.

Ø 48 cm, ↑ 180 cm

Glas / Glass: 1401

Dimmer Memory Funktion
Dimmer Memory Function

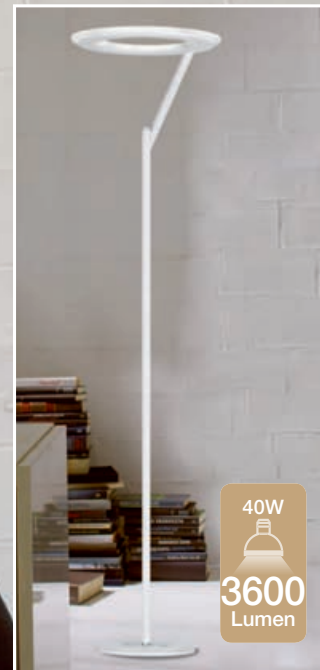

40W
3600
Lumen

3 Clarc / Serie 505
3505.01.34.0000
EAN4003474287171
Weiß/Chrom / White/Chrome

 1 x LED / 40 W incl.
3000 K / 1 x 3600 lm

Energieeffizienzklasse /
energy efficiency class:

A+

Markenleuchtmittel /
branded lamp incl.

Ø 48 cm, ↑ 180 cm

Glas / Glass: 1401

Dimmer Memory Funktion
Dimmer Memory Function



4 Clarc / Serie 505
9505.01.24.0000
 EAN4003474287225
 Schwarz/Chrom / Black/Chrome



1 x LED / 40 W incl.
 3000 K / 1 x 3600 lm

Energieeffizienzklasse /
 energy efficiency class:



Markenleuchtmittel /
 branded lamp incl.

Ø 48 cm, ↑ 37 cm

Glas / Glass: 1403

Dimmbar mittels ge-
 eignetem Wanddimmer /
 dimmable by suitable
 wall dimmer



40W

3600
 Lumen



5 Clarc / Serie 505
9505.01.34.0000
 EAN4003474287232
 Weiß/Chrom / White/Chrome



1 x LED / 40 W incl.
 3000 K / 1 x 3600 lm

Energieeffizienzklasse /
 energy efficiency class:



Markenleuchtmittel /
 branded lamp incl.

Ø 48 cm, ↑ 37 cm

Glas / Glass: 1403

Dimmbar mittels ge-
 eignetem Wanddimmer /
 dimmable by suitable
 wall dimmer



New!

New!

LED Light
 by **WOFI**

Hier geht's in Sachen Beleuchtung rund

Mit avantgardistischer Form und Dimmbarkeit
 setzen Sie beeindruckende Lichtakzente und
 präsentieren Ihre Räumlichkeit im schönsten
 Licht.

All around the subject of lighting

With its innovative form and by clever dimming
 you can create impressive lighting accents that
 show off your living room at its best.

6 Clarc / Serie 505
8505.01.34.0000
 EAN4003474287201
 Weiß/Chrom / White/Chrome



1 x LED / 20 W incl.
 3000 K / 1 x 1800 lm

Energieeffizienzklasse /
 energy efficiency class:



Markenleuchtmittel /
 branded lamp incl.

Ø 35 cm, ↑ 50 cm

Glas / Glass: 1402

Dimmer Memory Funktion
 Dimmer Memory Function



20W

1800
 Lumen

CLARC | Serie 505

LED Light
by WOFI®



1 Clarc / Serie 505
3505.01.54.0000
EAN4003474287164
Nickel-matt / Chrom
Nickel matt finished / Chrome



1 x LED / 40 W incl.
3000 K / 1 x 3600 lm

Energieeffizienzklasse /
energy efficiency class:

A+

Markenleuchtmittel /
branded lamp incl.

Ø 48 cm, ↑ 180 cm

Glas / Glass: 1401



Dimmer Memory Funktion
Dimmer Memory Function

030

Premium Product of WOFI® Germany



2 Clarc / Serie 505
9505.01.54.0000
 EAN4003474287249
 Nickel-matt / Chrom
 Nickel matt finished / Chrome

1 x LED / 40 W incl.
 3000 K / 1 x 3600 lm

Energieeffizienzklasse /
 energy efficiency class:

A+

Markenleuchtmittel /
 branded lamp incl.

Ø 48 cm, ↑ 37 cm

Glas / Glass: 1403

Dimmbar mittels geeignetem Wanddim-
 mer / dimmable by suitable wall dimmer



New!
New!



3 Clarc / Serie 505
8505.01.54.0000
 EAN4003474287218
 Nickel-matt / Chrom
 Nickel matt finished / Chrome

1 x LED / 20 W incl.
 3000 K / 1 x 1800 lm

Energieeffizienzklasse /
 energy efficiency class:

A+

Markenleuchtmittel /
 branded lamp incl.

Ø 35 cm, ↑ 50 cm

Glas / Glass: 1402

Dimmer Memory Funktion
 Dimmer Memory Function



Elegante Raumwunder

...Elegant space savers

Vorbildlich

Diese Serie ist ein Musterbeispiel dafür, dass schönes Design auch Platz für Funktionalität lassen kann.

Exemplary

Proof positive that beautiful design can work with functionality.



1 Vannes / Serie 625
7625.01.01.0000
EAN4003474280608
Chrom / Chrome



1 x LED / 40 W incl.
3000 K / 1 x 2600 lm

Energieeffizienzklasse /
energy efficiency class:

A

Markenleuchtmittel /
branded lamp incl.

↓ 150 cm, ↔ 127 cm, ↗ 14,5 cm

40W

2600
Lumen

Dimmbar mittels geeignetem
Wanddimmer / dimmable by sui-
table wall dimmer





2 Vannes / Serie 625
9625.01.01.0000
 EAN4003474285856
 Chrom / Chrome



1 x LED / 21,5 W incl.
 3000 K / 1 x 1400 lm

Energieeffizienzklasse /
 energy efficiency class:



Markenleuchtmittel /
 branded lamp incl.

↔ 61,5 cm, ⊥ 10,5 cm

Dimmbar mittels geeignetem
 Wanddimmer / dimmable by
 suitable wall dimmer



21,5W

1400
 Lumen



8,5W

550
 Lumen

3 Vannes / Serie 625
4625.01.01.0000
 EAN4003474004211
 Chrom / Chrome



1 x LED / 8,5 W incl.
 3000 K / 1 x 550 lm

Energieeffizienzklasse /
 energy efficiency class:



Markenleuchtmittel /
 branded lamp incl.

⊥ 11,5 cm, ↔ 32 cm, ↔ 11,5 cm



10,5W

680
 Lumen

4 Vannes / Serie 625
8625.01.01.0000
 EAN4003474280622
 Chrom / Chrome



1 x LED / 10,5 W incl.
 3000 K / 1 x 680 lm

Energieeffizienzklasse /
 energy efficiency class:



Markenleuchtmittel /
 branded lamp incl.

∅ 12,5 cm, ⊥ 39 cm



3-Stufen dimmbar
 3-step dimmable

5 Vannes / Serie 625
3625.01.01.0000
 EAN4003474280615
 Chrom / Chrome



1 x LED / 36 W incl.
 3000 K / 1 x 2340 lm

Energieeffizienzklasse /
 energy efficiency class:



Markenleuchtmittel /
 branded lamp incl.

⊥ 143 cm, ↔ 22 cm



3-Stufen dimmbar
 3-step dimmable

36W

2340
 Lumen



Neu!
Neu!

Hier kommt futuristisches Design ans Licht

...Shedding light on futuristic design



1 Comte / Serie 888
7888.01.64.0000
EAN4003474293424
Nickel-matt /
Nickel matt finished



1 x LED / 32 W incl.
3000 K / 1 x 2160 lm

Energieeffizienzklasse /
energy efficiency class:

A

Markenleuchtmittel /
branded lamp incl.

↑ 150 cm, ↔ 100 cm
Dimmbar mittels geeignetem Wanddimmer /
dimmable by suitable wall dimmer



32W

2160
Lumen

2 Comte / Serie 888
9888.01.64.0000
 EAN4003474293448
 Nickel-matt /
 Nickel matt finished



1 x LED / 32 W incl.
 3000 K / 1 x 2160 lm

Energieeffizienzklasse /
 energy efficiency class:



Markenleuchtmittel /
 branded lamp incl.

↓ 23 cm, ↔ 100 cm
 Dimmbar mittels geeignetem
 Wanddimmer / dimmable by
 suitable wall dimmer



32W

2160
 Lumen

3 Comte / Serie 888
8888.01.64.0000
 EAN4003474293431
 Nickel-matt /
 Nickel matt finished



1 x LED / 12 W incl.
 3000 K / 1 x 700 lm

Energieeffizienzklasse /
 energy efficiency class:



Markenleuchtmittel /
 branded lamp incl.

↓ 42 cm, Ø 12 cm
 3-Stufen dimmbar
 3-step dimmable



12W

700
 Lumen

LED Light
 by **WOFI**

Stilvoll & effizient

Eine hochwertige Verarbeitung,
 beeindruckendes Design und
 energiesparende LED-Technik bilden
 das Fundament der Serie COMTE.

Stylish & efficient

High quality processing, great design
 and energy saving LED technology
 are the foundation of the COMTE
 series.



43W

2700
 Lumen

5 Comte / Serie 888
3888.01.64.0000
 EAN4003474293400
 Nickel-matt /
 Nickel matt finished



1 x LED / 43 W incl.
 3000 K / 1 x 2700 lm

Energieeffizienzklasse /
 energy efficiency class:



Markenleuchtmittel /
 branded lamp incl.

↓ 150 cm, Ø 25 cm
 3-Stufen dimmbar
 3-step dimmable



4 Comte / Serie 888
4888.01.64.0000
 EAN4003474293417
 Nickel-matt /
 Nickel matt finished



1 x LED / 7 W incl.
 3000 K / 1 x 420 lm

Energieeffizienzklasse /
 energy efficiency class:



Markenleuchtmittel /
 branded lamp incl.

↔ 32 cm, ↗ 8 cm, ⇄ 7 cm
 3-Stufen dimmbar /
 3-step dimmable



7W

420
 Lumen

Funktion folgt modernem Design

...function follows modern design

LED Light
by **WOFI**



1 Colmar / Serie 234
8234.01.01.0000
EAN4003474280806
Chrom / Chrome



1 x LED / 10,2 W incl.
3000 K / 1 x 660 lm

Energieeffizienzklasse /
energy efficiency class:



Markenleuchtmittel /
branded lamp incl.

⌈ 44 cm, ↔ 10 cm, ↗ 15 cm



3-Stufen dimmbar
3-step dimmable

10,2W

660
Lumen



28,8W
1870
Lumen

3 Colmar / Serie 234
3234.01.01.0000
EAN4003474255002
Chrom / Chrome

1 x LED / 26,4 W incl.
3000 K / 1 x 1720 lm

Energieeffizienzklasse /
energy efficiency class:

A

Markenleuchtmittel /
branded lamp incl.

↓ 142 cm, ↔ 17 cm, ↗ 23 cm

3-Stufen dimmbar
3-step dimmable

26,4W
1720
Lumen

2 Colmar / Serie 234
7234.01.01.0000
EAN4003474280783
Chrom / Chrome

1 x LED / 28,8 W incl.
3000 K / 1 x 1870 lm

Energieeffizienzklasse /
energy efficiency class:

A

Markenleuchtmittel /
branded lamp incl.
↓ 150 cm, ↔ 120 cm, ↗ 8 cm

Dimmbar mittels geeig-
netem Wanddimmer /
dimmable by suitable wall
dimmer



Neu!
Neu!



6,8W
440
Lumen

4 Colmar / Serie 234
4234.01.01.0000
EAN4003474280790
Chrom / Chrome

1 x LED / 6,8 W incl.
3000 K / 1 x 440 lm

Energieeffizienzklasse /
energy efficiency class:

A

Markenleuchtmittel /
branded lamp incl.

↔ 31 cm, ↓ 8 cm, ↗ 7 cm

3-Stufen dimmbar
3-step dimmable



1 Logan / Serie 175
7175.05.01.0000
EAN4003474282879
Chrom / Chrome



5 x LED / 4,2 W incl.
3000 K / 5 x 270 lm

Energieeffizienzklasse /
energy efficiency class:

A⁺

Markenleuchtmittel /
branded lamp incl.

↑ 150 cm, ↔ 93 cm, ↗ 7 cm

Glas / Glass: 6587

Dimmbar mittels geeignetem
Wanddimmer / dimmable by
suitable wall dimmer



4,2W



270
Lumen

LED Light
by **WOFI**



Neu!

Neu!

*Licht in seiner
schönsten Form*

...light in its most beautiful form



2 Soul / Serie 117
9117.01.54.0000
EAN4003474291031
Nickel-matt / Chrom /
Nickel matt finished / Chrome



1 x LED / 44 W incl.
3000 K / 1 x 3000 lm

Energieeffizienzklasse /
energy efficiency class:

A

↔ 61 cm, ↗ 55 cm, ⊥ 6,5 cm

Dimmbar mittels geeignetem Wanddimmer /
dimmable by suitable wall dimmer



44W
3000
Lumen

3 Logan / Serie 175
7175.07.01.0000
 EAN4003474282886
 Chrom / Chrome

 7 x LED / 4,2 W incl.
 3000 K / 7 x 270 lm

Energieeffizienzklasse /
 energy efficiency class:

A⁺

Markenleuchtmittel /
 branded lamp incl.

↓ 150 cm, ↔ 73 cm, ↗ 22 cm

Glas / Glass: 6587

Dimmbar mittels geeignetem
 Wanddimmer / dimmable by
 suitable wall dimmer



4,2W

270
 Lumen



4 Logan / Serie 175
9175.04.01.0000
 EAN4003474286396
 Chrom / Chrome

 4 x LED / 4,2 W incl.
 3000 K / 4 x 270 lm

Energieeffizienzklasse /
 energy efficiency class:

A⁺

Markenleuchtmittel /
 branded lamp incl.

↓ 27,5 cm, ↔ 27,5 cm, ⊥ 8 cm

Glas / Glass: 6587

Dimmbar mittels geeignetem
 Wanddimmer / dimmable by
 suitable wall dimmer



5 Logan / Serie 175
9175.09.01.0000
 EAN4003474286402
 Chrom / Chrome

 9 x LED / 4,2 W incl.
 3000 K / 9 x 270 lm

Energieeffizienzklasse /
 energy efficiency class:

A⁺

Markenleuchtmittel /
 branded lamp incl.

↓ 42 cm, ↔ 42 cm, ⊥ 8 cm

Glas / Glass: 6587

Dimmbar mittels geeignetem
 Wanddimmer / dimmable by
 suitable wall dimmer



50W
3500
Lumen



1 Louvre / Serie 825
3825.01.54.0000
EAN4003474274126
Nickel-matt / Chrom
Nickel matt finished / Chrome

 1 x LED / 50 W incl.
3000 K / 1 x 3500 lm

Energieeffizienzklasse /
energy efficiency class:

A

Markenleuchtmittel /
branded lamp incl.

↑ 145 cm, ↔ 24 cm



40W
2700
Lumen

2 Louvre / Serie 825
7825.01.54.0000
EAN4003474274140
Nickel-matt / Chrom
Nickel matt finished / Chrome

 1 x LED / 40 W incl.
3000 K / 1 x 2700 lm

Energieeffizienzklasse /
energy efficiency class:

A

Markenleuchtmittel /
branded lamp incl.

↔ 111,5 cm, ↑ 150 cm

Dimmbar mittels geeignetem
Wanddimmer / *dimmable by*
suitable wall dimmer



3 Louvre / Serie 825
8825.01.54.0000
EAN4003474274157
Nickel-matt / Chrom
Nickel matt finished / Chrome

 1 x LED / 20 W incl.
3000 K / 1 x 1400 lm

Energieeffizienzklasse /
energy efficiency class:

A

Markenleuchtmittel /
branded lamp incl.

↑ 58,5 cm, ↔ 18 cm



20W
1400
Lumen

Die sorgen für Wellen der Begeisterung

...Carried away by waves of enthusiasm



LED Light
by **WOFI**

4 Louvre / Serie 825
9825.01.54.0000
EAN4003474274560
Nickel-matt / Chrom
Nickel matt finished / Chrome

 1 x LED / 10 W incl.
3000 K / 1 x 700 lm

Energieeffizienzklasse /
energy efficiency class:

A

Markenleuchtmittel /
branded lamp incl.

↑ 10,5 cm, ↔ 58 cm

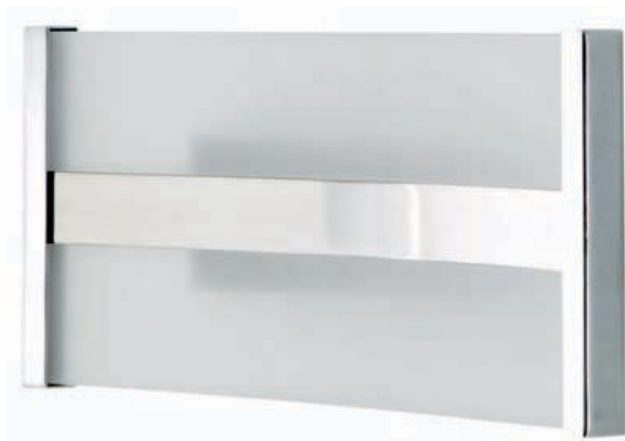

10W

700
Lumen

5 Louvre / Serie 825
4825.01.54.0000
EAN4003474274133
Nickel-matt / Chrom
Nickel matt finished / Chrome

 1 x LED / 10 W incl.
3000 K / 1 x 700 lm

Energieeffizienzklasse /
energy efficiency class:

A

Markenleuchtmittel /
branded lamp incl.

↔ 29 cm, ↑ 13 cm, ⇨ 7 cm



New!

New!



L Louvre / Serie 825
7825.01.54.1000
EAN4003474291208
Nickel-matt / Chrom /
Nickel matt finished / Chrome



1 x LED / 16,2 W incl.
3000 K / 1 x 1132 lm

Energieeffizienzklasse /
energy efficiency class:

A

Markenleuchtmittel /
branded lamp incl.

↓ 150 cm, ↔ 112 cm, ↗ 6,8 cm

Dimmbar mittels geeignetem
Wanddimmer / dimmable by
suitable wall dimmer



16,2W

1132
Lumen

1 Avignon / Serie 275
4275.01.64.0000
EAN4003474281513
Nickel-matt / Nickel matt finished



1 x LED / 6,6 W incl.
3000 K / 1 x 450 lm

Energieeffizienzklasse /
energy efficiency class:

A

Markenleuchtmittel /
branded lamp incl.

∩ 30 cm, ↔ 4,5 cm, ∟ 8 cm

Glas / Glass: 1039, ∩ 31 cm, ↔ 8 cm



Neu!
Neu!



6,6W

450
Lumen



12W

700
Lumen



27W

1900
Lumen

2 Avignon / Serie 275
8275.01.64.0000
EAN4003474281544
Nickel-matt / Nickel matt finished



1 x LED / 12 W incl.
3000 K / 1 x 700 lm

Energieeffizienzklasse /
energy efficiency class:

A

Markenleuchtmittel /
branded lamp incl.

∩ 37,6 cm, ↔ 11 cm, ∟ 11 cm

Glas / Glass: 3001, ∩ 37 cm, ↔ 8 cm



3-Stufen dimmbar
3-step dimmable

3 Avignon / Serie 275
3275.01.64.0000
EAN4003474281506
Nickel-matt / Nickel matt finished



1 x LED / 27 W incl.
3000 K / 1 x 1900 lm

Energieeffizienzklasse /
energy efficiency class:

A

Markenleuchtmittel /
branded lamp incl.

∩ 121,5 cm, ↔ 20 cm, ∟ 20 cm

Glas / Glass: 3000, ∩ 123 cm, ↔ 12 cm



3-Stufen dimmbar
3-step dimmable



Avignon / Serie 275
7275.01.64.0000
EAN4003474281520
Nickel-matt /
Nickel matt finished



1 x LED / 24 W incl.
3000 K / 1 x 1700 lm

Energieeffizienzklasse /
energy efficiency class:

A

Markenleuchtmittel /
branded lamp incl.

↓ 150 cm, ↔ 80 cm, ↗ 15 cm

Glas / Glass: 1040, ↔ 80 cm

Dimmbar mittels geeignetem
Wanddimmer / dimmable by
suitable wall dimmer

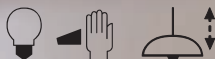

24W

1700
Lumen



7W
430
Lumen

Neu!
Neu!

Die ansprechende Symmetrie, das eingesetzte Material sowie die moderne LED-Technologie sind in dieser Kombination herausstechend.

The pleasing symmetry, the materials used and modern LED technology are truly outstanding in this combination.



2 Avignon / Serie 275
9275.05.64.0000
EAN4003474290621
Nickel-matt /
Nickel matt finished



5 x LED / 7 W incl.
3000 K / 5 x 430 lm

Energieeffizienzklasse /
energy efficiency class:

A

Markenleuchtmittel /
branded lamp incl.

Ø 63 cm, **H** 8,5 cm

Glas / Glass: 1426, **I** 30,8 cm

Dimmbar mittels geeignetem
Wanddimmer / dimmable by
suitable wall dimmer



3 Avignon / Serie 275
9275.03.64.0000
EAN4003474290614
Nickel-matt /
Nickel matt finished



3 x LED / 7 W incl.
3000 K / 3 x 430 lm

Energieeffizienzklasse /
energy efficiency class:

A

Markenleuchtmittel /
branded lamp incl.

Ø 61,5 cm, **H** 7 cm

Glas / Glass: 1426, **I** 30,8 cm

Dimmbar mittels geeignetem
Wanddimmer / dimmable by
suitable wall dimmer



7W
430
Lumen

5W
400
Lumen

LED Light
by WOFI®



1 Maar / Serie 806
7806.05.01.0000
EAN4003474274072
Chrom / Chrome



5 x LED / 5 W incl.
3000 K / 5 x 400 lm

Energieeffizienzklasse /
energy efficiency class:

A+

Markenleuchtmittel /
branded lamp incl.

∟ 150 cm, ↔ 96 cm

Dimmbar mittels ge-
eignetem Wanddimmer /
dimnable by suitable
wall dimmer



5W
430
Lumen

2 Midu / Serie 193
4193.01.01.0000
EAN4003474280714
Chrom / Chrome



1 x LED / 5 W incl.
3000 K / 1 x 430 lm

Energieeffizienzklasse /
energy efficiency class:

A+

Markenleuchtmittel /
branded lamp incl.

∟ 23 cm, ↔ 8,5 cm, ⇄ 14 cm

Glas / Glass: 6609, Ø 3,6 cm,
∟ 8,2 cm



3 Midu / Serie 193
9193.06.01.0000
EAN4003474281124
Chrom / Chrome



6 x LED / 5 W incl.
3000 K / 6 x 430 lm

Energieeffizienzklasse /
energy efficiency class:

A+

Markenleuchtmittel /
branded lamp incl.

Ø 45,6 cm, ∟ 14,5 cm

Glas / Glass: 6609,
Ø 3,6 cm, ∟ 8,2 cm

LED Light
by **WOFI**

4 Kent / Serie 060
9060.06.01.0000
EAN4003474283272
Chrom / Chrome

 6 x LED / 5 W incl.
3000 K / 6 x 380 lm

Energieeffizienzklasse /
energy efficiency class:

A+

Markenleuchtmittel /
branded lamp incl.

Ø 25 cm, ↓ 16 cm

Glas / Glass: 1406, Ø 4 cm,
↓ 10 cm



5W

380
Lumen

6 Midu / Serie 193
8193.01.01.0000
EAN4003474284248
Chrom / Chrome

 1 x LED / 5 W incl.
3000 K / 1 x 430 lm

Energieeffizienzklasse /
energy efficiency class:

A+

Markenleuchtmittel /
branded lamp incl.

Ø 10 cm, ↓ 25 cm

Glas / Glass: 6609,
Ø 3,6 cm, ↓ 8,2 cm



New!

New!

5W

430
Lumen

5 Midu / Serie 193
3193.05.01.0000
EAN4003474284231
Chrom / Chrome

 5 x LED / 5 W incl.
3000 K / 5 x 430 lm

Energieeffizienzklasse /
energy efficiency class:

A+

Markenleuchtmittel /
branded lamp incl.

Ø 50 cm, ↓ 160 cm

Glas / Glass: 6609,
Ø 3,6 cm, ↓ 8,2 cm



7 Midu / Serie 193
9193.03.01.0000
EAN4003474280738
Chrom / Chrome

 3 x LED / 5 W incl.
3000 K / 3 x 430 lm

Energieeffizienzklasse /
energy efficiency class:

A+

Markenleuchtmittel /
branded lamp incl.

Ø 43,5 cm, ↓ 14,6 cm

Glas / Glass: 6609, Ø 3,6 cm,
↓ 8,2 cm



LUZ / Serie 682
3682.01.01.0500
EAN4003474264493
Chrom / Chrome



1 x LED / 30 W incl.
3000 K / 1 x 3000 lm

Energieeffizienzklasse /
energy efficiency class:

A+

∟ 185 cm, ∟ 102,5 cm

3-Stufen dimmbar
3-step dimmable



*Die haben
den Bogen raus*
...Convenient curves

30W

3000
Lumen



2 Luz / Serie 682
3682.01.01.0000
EAN4003474259598
Chrom / Chrome

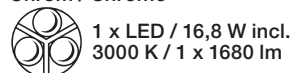

Energieeffizienzklasse /
energy efficiency class:



↑ 165 cm, ⇨ 48 cm

3-Stufen dimmbar
3-step dimmable



3 Luz / Serie 682
4682.01.01.0000
EAN4003474259567
Chrom / Chrome



Energieeffizienzklasse /
energy efficiency class:



↑ 37cm, ⇨ 10,5 cm



Stil trifft Machbarkeit

Die Serie LUZ gehört zu den Kollektionen, die Stil und Convenience locker vereinen: Mit dem geschwungenen Design machen sich die Leuchten gut als Solisten. Sie lassen aber auch genügend Raum: für Mobiliar, zum Beispiel zwischen Standbein und tatsächlicher Lichtzone.

Style meets practicality

The LUZ series is one of those collections that effortlessly combines style and convenience. With their curved design, the lamps make a great solo statement, and as they give maximum space between the base and the area they illuminate, they leave more space for your furniture.

4 Luz / Serie 682
8682.01.01.0000
EAN4003474259604
Chrom / Chrome

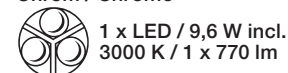

Energieeffizienzklasse /
energy efficiency class:



↑ 40 cm, ⇨ 30 cm, ↗ 10 cm

3-Stufen dimmbar
3-step dimmable

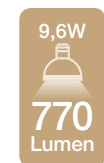

1 Luz / Serie 682
8682.01.64.0000
EAN4003474279855
Nickel-matt / Nickel matt finished



 1 x LED / 9,6 W incl.
3000 K / 1 x 770 lm

Energieeffizienzklasse /
energy efficiency class:

A+

Markenleuchtmittel /
branded lamp incl.

↑ 40 cm, ↗ 10 cm, ⇨ 30 cm

  3-Stufen dimmbar
3-step dimmable

9,6W

770
Lumen

LED Light
by **WOFI**

16,8W

1680
Lumen

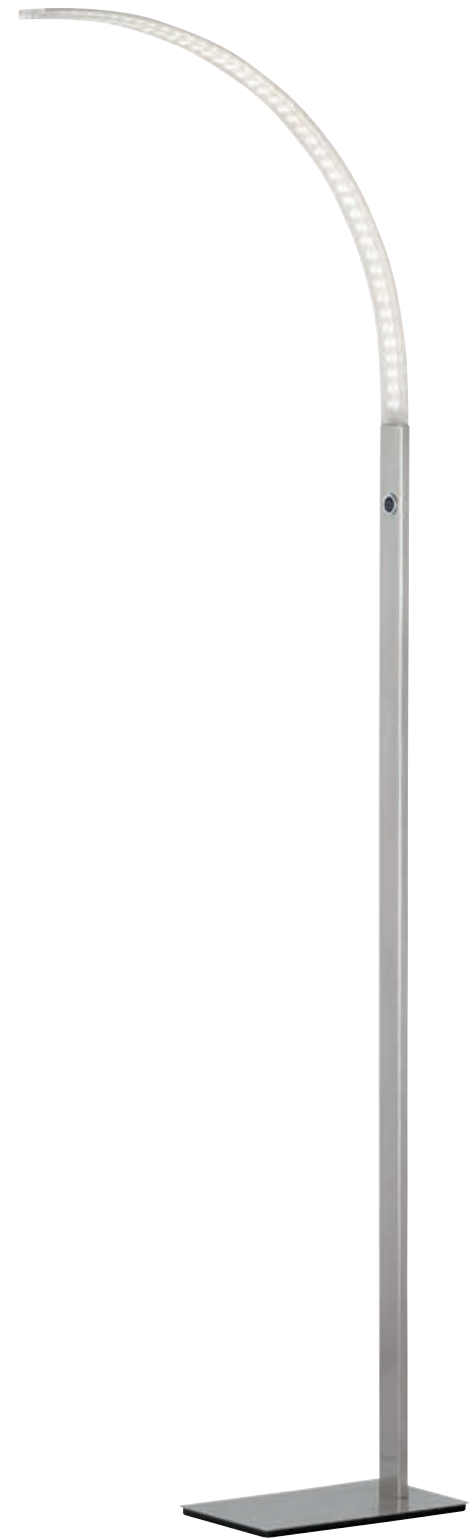

New!
New!

2 Luz / Serie 682
3682.01.64.0000
EAN4003474279213
Nickel-matt /
Nickel matt finished

 1 x LED / 16,8 W incl.
3000 K / 1 x 1680 lm

Energieeffizienzklasse /
energy efficiency class:

A+

Markenleuchtmittel /
branded lamp incl.

↑ 165 cm, ⇨ 48 cm

3-Stufen dimmbar
3-step dimmable

21W
1470
Lumen



3 Luz / Serie 682
7682.01.64.0500
EAN4003474279220
Nickel-matt /
Nickel matt finished

 1 x LED / 21 W incl.
3000 K / 1 x 1470 lm

Energieeffizienzklasse /
energy efficiency class:

A

Markenleuchtmittel /
branded lamp incl.
↓ 150 cm, ↔ 100 cm, ↗ 6 cm
Dimmbar mittels geeignetem
Wanddimmer / dimmable by
suitable wall dimmer



30W
3000
Lumen

4 Luz / Serie 682
3682.01.64.0500
EAN4003474279206
Nickel-matt /
Nickel matt finished

 1 x LED / 30 W incl.
3000 K / 1 x 3000 lm

Energieeffizienzklasse /
energy efficiency class:

A+

Markenleuchtmittel /
branded lamp incl.
↓ 185 cm, ↔ 102,5 cm
3-Stufen dimmbar
3-step dimmable

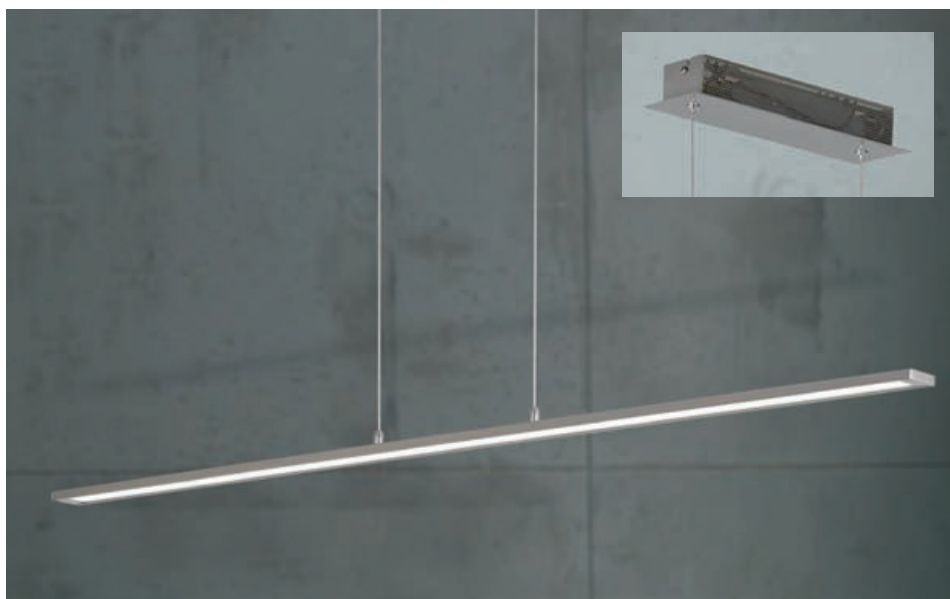

25W
1750
Lumen

5 Luz / Serie 682
7682.01.64.1200
EAN4003474289496
Nickel-matt /
Nickel matt finished

 1 x LED / 25 W incl.
3000 K / 1 x 1750 lm

Energieeffizienzklasse /
energy efficiency class:

A

Markenleuchtmittel /
branded lamp incl.
↓ 150 cm, ↔ 120 cm, ↗ 6 cm

Dimmbar mittels geeignetem
Wanddimmer / dimmable by
suitable wall dimmer





1 Nero / Serie 277
3277.06.22.0000
EAN4003474291246
Messing modern /
Brass modern

 6 x LED / 4,2 W incl.
2700 K / 6 x 400 lm

Energieeffizienzklasse /
energy efficiency class:

A+

Markenleuchtmittel /
branded lamp incl.

↓ 120 cm, ↔ 15 cm, ↗ 20 cm



Minimalismus trifft Eleganz

...Minimalism
meets elegance

4,2W

400
Lumen

2 Nero / Serie 277
3277.06.64.0000
EAN4003474290041
Nickel-matt /
Nickel matt finished

 6 x LED / 4,2 W incl.
3000 K / 6 x 400 lm

Energieeffizienzklasse /
energy efficiency class:

A+

Markenleuchtmittel /
branded lamp incl.

↓ 120 cm, ↔ 15 cm, ↗ 20 cm



4,2W
400
Lumen

3 Nero / Serie 277
6277.05.64.0000
EAN4003474290034
Nickel-matt /
Nickel matt finished

 5 x LED / 4,2 W incl.
3000 K / 5 x 400 lm

Energieeffizienzklasse /
energy efficiency class:

A+

Markenleuchtmittel /
branded lamp incl.

↑ 150 cm, ↔ 100 cm, ↗ 6 cm

Dimmbar mittels geeignetem
Wanddimmer / dimmable by
suitable wall dimmer



New!

New!

LED Light
by **WOFI**

Machen überall eine gute Figur

Die Leuchten der Serie NERO bringen
eine warme Lichtstimmung in bestimmte
Wohnzonen.

Always a good look

The lamps of the NERO series create
a warm atmosphere in any home.

4 Nero / Serie 277
6277.05.22.0000
EAN4003474291055
Messing modern /
Brass modern

 5 x LED / 4,2 W incl.
2700 K / 5 x 400 lm

Energieeffizienzklasse /
energy efficiency class:

A+

Markenleuchtmittel /
branded lamp incl.

↑ 150 cm, ↔ 100 cm, ↗ 6 cm

Dimmbar mittels geeignetem
Wanddimmer / dimmable by
suitable wall dimmer



7,2W
580
Lumen



1 Voss / Serie 379
8379.01.01.0000
EAN4003474265889
Chrom / Chrome



1 x LED / 7,2 W incl.
3000 K / 1 x 580 lm

Energieeffizienzklasse /
energy efficiency class:

A+

Markenleuchtmittel /
branded lamp incl.

∫ 60 cm , ↔ 21 cm , ⇨ 60 cm



2 Voss / Serie 379
3379.01.01.0000
EAN4003474265896
Chrom / Chrome



1 x LED / 7,2 W incl.
3000 K / 1 x 580 lm

Energieeffizienzklasse /
energy efficiency class:

A+

Markenleuchtmittel /
branded lamp incl.

∫ 160 cm , ↔ 26,5 cm , ⇨ 60 cm



6162

6163

40W
3600
Lumen

5W
450
Lumen

3 Voss / Serie 379
3379.02.54.0000
EAN4003474273914
Nickel-matt / Chrom
Nickel matt finished / Chrome



1 x LED / 40 W incl.
3000 K / 1 x 3600 lm



1 x LED / 5 W incl.
3000 K / 1 x 450 lm

Energieeffizienzklasse /
energy efficiency class:

A+

Markenleuchtmittel /
branded lamp incl.

∫ 180 cm , ↔ 45 cm , ⇨ 50 cm

Glas / Glass:

6162, ↔ 45 cm, ∫ 29 cm

6163, ↔ 12 cm, ∫ 8 cm



LED Light
by **WOFI**

4 Voss / Serie 379
7379.05.01.0000
EAN4003474264134
Chrom / Chrome



5 x LED / 4,8 W incl.
3000 K / 5 x 410 lm

Energieeffizienzklasse /
energy efficiency class:

A+

Markenleuchtmittel /
branded lamp incl.

∩ 150 cm , ↔ 90 cm

Glas / Glass: 6235
↔ 90 cm, ∩ 14 cm

Dimmbar mittels geeignetem
Wanddimmer / dimmable by
suitable wall dimmer



4,8W



410
Lumen

Schöner Schein vom Tisch bis zur Decke

...Shining beautifully from
tabletop to ceiling

Dimmen wird hier
zur hellen Freude

Let the dimmer
brighten up the show

Ob Steh- oder Hängeleuchte, Sie allein
bestimmen den Grad der Helligkeit – ganz
einfach per Dimmer.

Whether standing or hanging lamps, you
decide how bright they should be – simply
by adjusting the dimmer.



6W
420
Lumen

1 Laurids / Serie 889
4889.01.64.0000
EAN4003474177960
Nickel-matt /
Nickel matt finished



1 x LED / 6 W incl.
3000 K / 1 x 420 lm

Energieeffizienzklasse /
energy efficiency class:

A

Markenleuchtmittel /
branded lamp incl.

↑ 9 cm, ↔ 12 cm, ⇄ 15 cm



3-Stufen dimmbar
3-step dimmable

Für jeden Raum das richtige Licht

...perfect light for every room

LED Light
by **WOFI**

New!

New!

11,2W
780
Lumen

2 Laurids / Serie 889
3889.01.64.0000
EAN4003474282749
Nickel-matt / Nickel matt finished



1 x LED / 11,2 W incl.
3000 K / 1 x 780 lm

Energieeffizienzklasse /
energy efficiency class:

A

Markenleuchtmittel /
branded lamp incl.

↑ 142 cm, ⇄ 56 cm



3 Laurids / Serie 889
8889.01.64.0000
EAN4003474282732
Nickel-matt / Nickel matt finished



1 x LED / 6 W incl.
3000 K / 1 x 420 lm

Energieeffizienzklasse /
energy efficiency class:

A

Markenleuchtmittel /
branded lamp incl.

↑ 40,5 cm, ↔ 13 cm, ⇄ 42,5 cm

3-Stufen dimmbar
3-step dimmable



6W
420
Lumen

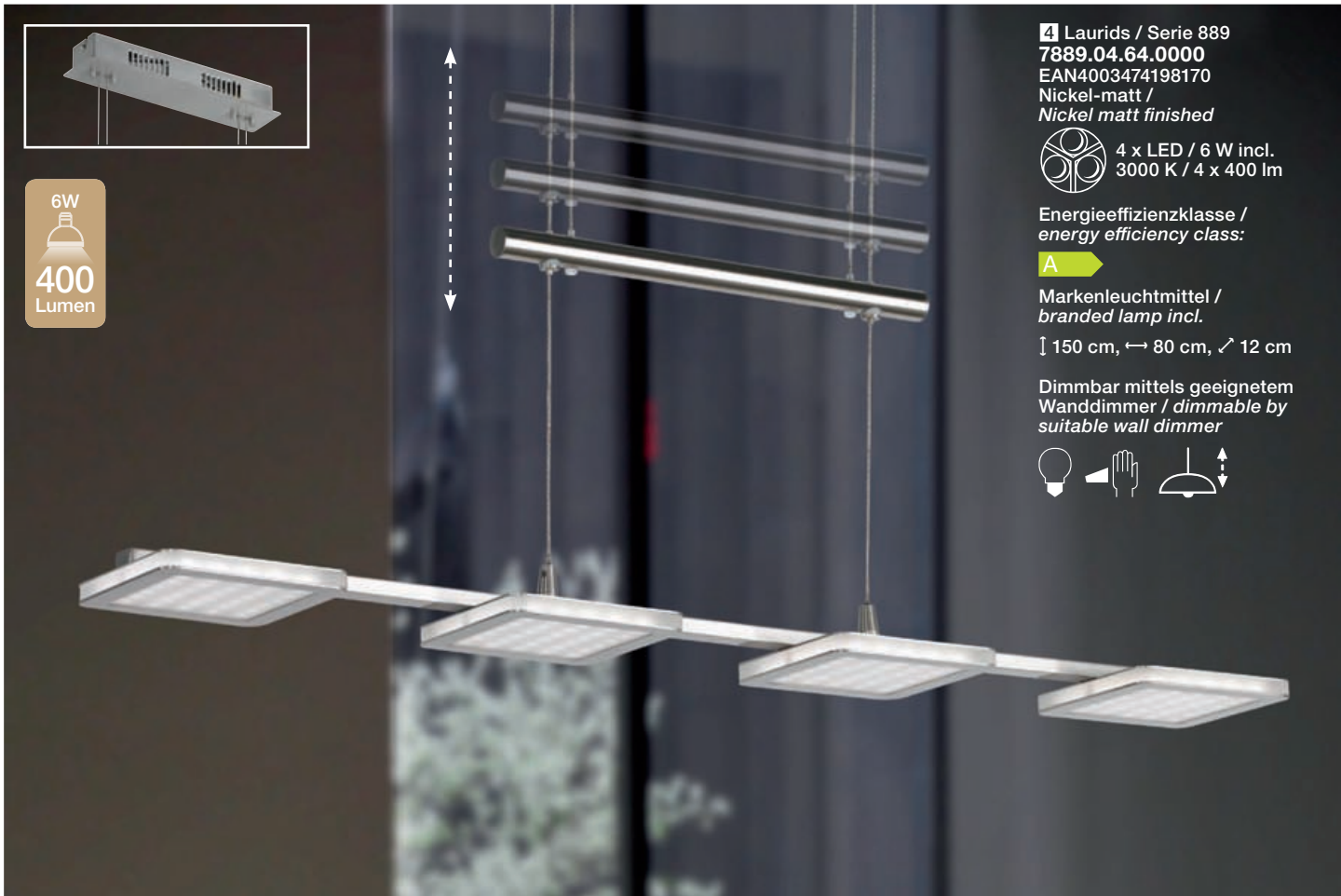

6W
400
Lumen

4 Laurids / Serie 889
7889.04.64.0000
EAN4003474198170
Nickel-matt /
Nickel matt finished

 4 x LED / 6 W incl.
3000 K / 4 x 400 lm

Energieeffizienzklasse /
energy efficiency class:

A

Markenleuchtmittel /
branded lamp incl.

↑ 150 cm, ↔ 80 cm, ↗ 12 cm

Dimmbar mittels geeignetem
Wanddimmer / dimmable by
suitable wall dimmer



5 Laurids / Serie 889
9889.04.64.0000
EAN4003474178004
Nickel-matt / Nickel matt finished

 4 x LED / 6 W incl.
3000 K / 4 x 400 lm

Energieeffizienzklasse /
energy efficiency class:

A

Markenleuchtmittel /
branded lamp incl.

↑ 38 cm, ↔ 38 cm, ↗ 5 cm

Dimmbar mittels geeignetem
Wanddimmer / dimmable by
suitable wall dimmer



6W
400
Lumen

Klare Formen und Strukturen!

Die Leuchten der Serie LAURIDS sind
aufgrund des Designs unverwechselbar
und individuell einsetzbar.

Clear shapes and structures!

The lights of the LAURIDS series are
distinctive and unique in design.



10W
700
Lumen



6 Laurids / Serie 889
9889.01.64.0000
EAN4003474291215
Nickel-matt /
Nickel matt finished

 1 x LED / 10 W incl.
3000 K / 1 x 700 lm

Energieeffizienzklasse /
energy efficiency class:

A

Markenleuchtmittel /
branded lamp incl.

↑ 17 cm, ↔ 17 cm, ↘ 4,3 cm

LED Light
by WOFI®

4,8W
410
Lumen

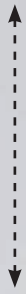

1 Darwin / Serie 613
7613.04.64.0000
EAN4003474268781
Nickel-matt /
Nickel matt finished

 4 x LED / 4,8 W incl.
3000 K / 4 x 410 lm

Energieeffizienzklasse /
energy efficiency class:

A+

Markenleuchtmittel /
branded lamp incl.

∩ 150 cm, ↔ 80 cm

Glas: satiniert / Glass: satined
Glas / Glass: 6269

↔ 11 cm, ∩ 8 cm

Dimmbar mittels geeignetem
Wanddimmer / dimmable by
suitable wall dimmer



2 Darwin / Serie 613
3613.01.64.0000
EAN4003474268774
Nickel-matt / Nickel matt finished

 1 x LED / 4,8 W incl.
3000 K / 1 x 410 lm

Energieeffizienzklasse /
energy efficiency class:

A+

Markenleuchtmittel /
branded lamp incl.

∩ 135 cm, ↔ 18 cm, ⇄ 60 cm

Glas: satiniert / Glass: satined
Glas / Glass: 6269

↔ 11 cm, ∩ 8 cm



3 Darwin / Serie 613
8613.01.64.0000
EAN4003474268798
Nickel-matt / Nickel matt finished

 1 x LED / 4,8 W incl.
3000 K / 1 x 410 lm

Energieeffizienzklasse /
energy efficiency class:

A+

Markenleuchtmittel /
branded lamp incl.

∩ 55 cm, ↔ 18 cm

Glas: satiniert / Glass: satined
Glas / Glass: 6269

↔ 11 cm, ∩ 8 cm



4 Darwin / Serie 613

7613.03.64.0000

EAN4003474111186

Nickel-matt /

Nickel matt finished

3 x LED / 4,8 W incl.
3000 K / 3 x 410 lmEnergieeffizienzklasse /
energy efficiency class:

A+

Markenleuchtmittel /
branded lamp incl.

] 150 cm, ↔ 57 cm

Glas: satiniert / Glass: satined

Glas / Glass: 6269

↔ 11 cm,] 8 cm

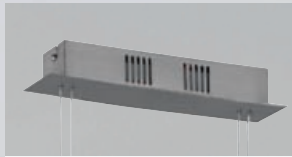
Dimmbar mittels ge-
eignetem Wanddimmer /
dimmable by suitable
wall dimmer

4,8W

410
Lumen

*Helle Momente
an jeder Ecke*

...Bright moments in every corner



1 Apart / Serie 366
7366.01.64.0000
 EAN4003474274256
 Nickel-matt /
 Nickel matt finished

Glas / Glass: 6208

Dimmbar mittels geeignetem Wanddimmer /
 dimmable by suitable wall dimmer

 1 x LED / 21,6 W incl.
 3000 K / 1 x 1730 lm

Energieeffizienzklasse /
 energy efficiency class:
A

Markenleuchtmittel /
 branded lamp incl.

↓ 150 cm, ↔ 102,5 cm

Acrylglas weiß satiniert /
 Acrylic glass white satin

21,6W
1730
 Lumen

LED Light
 by **WOFI**

2 Apart / Serie 366
3366.01.64.0000
 EAN4003474274225
 Nickel-matt /
 Nickel matt finished

 1 x LED / 21,6 W incl.
 3000 K / 1 x 1730 lm

Energieeffizienzklasse /
 energy efficiency class:
A

Markenleuchtmittel /
 branded lamp incl.

↓ 120 cm, ↔ 16 cm

Acrylglas weiß satiniert /
 Acrylic glass white satin
 Glas / Glass: 6190

21,6W
1730
 Lumen

3 Apart / Serie 366
8366.01.64.0000
 EAN4003474274263
 Nickel-matt /
 Nickel matt finished

 1 x LED / 7,2 W incl.
 3000 K / 1 x 420 lm

Energieeffizienzklasse /
 energy efficiency class:
A

Markenleuchtmittel /
 branded lamp incl.

↓ 40 cm, ↔ 16 cm

Acrylglas weiß satiniert /
 Acrylic glass white satin
 Glas / Glass: 6209

7,2W
420
 Lumen





4 Apart / Serie 366
4366.01.64.0000
 EAN4003474274249
 Nickel-matt /
 Nickel matt finished

Markenleuchtmittel /
 branded lamp incl.

↓ 6 cm, ↔ 30 cm, ⇨ 11 cm

Acrylglas weiß satiniert /
 Acrylic glass white satin
 Glas / Glass: 6206

 1 x LED / 5,8 W incl.
 3000 K / 1 x 336 lm

Energieeffizienzklasse /
 energy efficiency class:
A

5,8W
336
 Lumen

Klares Design sorgt für klare Lichtverhältnisse

...Sleek design for clear,
 crisp light

Highlight

Pure Formen aus Nickel und hochwertig verarbeiteten Acryl-Gläsern lassen die Serie APART zum Blickfang werden.

Highlight

Pure nickel shapes and high quality acrylic glass make the APART series a feast for the eyes.

1 Mercur / Serie 313
7313.01.01.0000
 EAN4003474268569
 Chrom / Chrome

1 x LED / 25 W incl.
 3000 K / 1 x 1750 lm

Energieeffizienzklasse /
 energy efficiency class:
A

Markenleuchtmittel /
 branded lamp incl.

↑ 150cm, ↔ 94 cm

Dimmbar mittels ge-
 eignetem Wanddimmer /
 dimmable by suitable
 wall dimmer

LED Light
 by **WOFI**



25W

1750
 Lumen

2 Mercur / Serie 313
4313.01.01.0000
 EAN4003474268552
 Chrom / Chrome

1 x LED / 4,8 W incl.
 3000 K / 1 x 336 lm

Energieeffizienzklasse /
 energy efficiency class:
A+

Markenleuchtmittel /
 branded lamp incl.

↑ 28 cm, ↔ 10 cm, ⇨ 14 cm

4,8W

336
 Lumen





3 Mercur / Serie 313
3313.01.01.0000
 EAN4003474268545
 Chrom / Chrome

1 x LED / 9,6 W incl.
 3000 K / 1 x 672 lm

Energieeffizienzklasse /
 energy efficiency class:
A

Markenleuchtmittel /
 branded lamp incl.

↑ 125 cm, ⇨ 52,5 cm

9,6W

672
 Lumen

**Gradlinige,
 glänzende Ideen**

FORMidabel: diese extravaganten
 Leuchten werden schnell zum Eye-
 catcher in Appartements, Lofts
 und Büros.

**Simply straightfor-
 ward, bright ideas**

FORMidable: these extravagant
 lamps will soon become eye
 catchers in every style of living area.



4 Mercur / Serie 313
8313.01.01.0000
 EAN4003474268576
 Chrom / Chrome

1 x LED / 7,2 W incl.
 3000 K / 1 x 504 lm

Energieeffizienzklasse /
 energy efficiency class:
A

Markenleuchtmittel /
 branded lamp incl.

↑ 40 cm, ↔ 12 cm, ⇨ 48 cm

7,2W

504
 Lumen





3W
189
Lumen

1 Orbit / Serie 946
4946.03.01.0000
EAN4003474282985
Chrom / Chrome

 3 x LED / 3 W incl.
3000 K / 3 x 189 lm

Energieeffizienzklasse /
energy efficiency class:
A+

Markenleuchtmittel /
branded lamp incl.
↑ 53,5 cm, ↔ 45,5 cm, ⇨ 8 cm

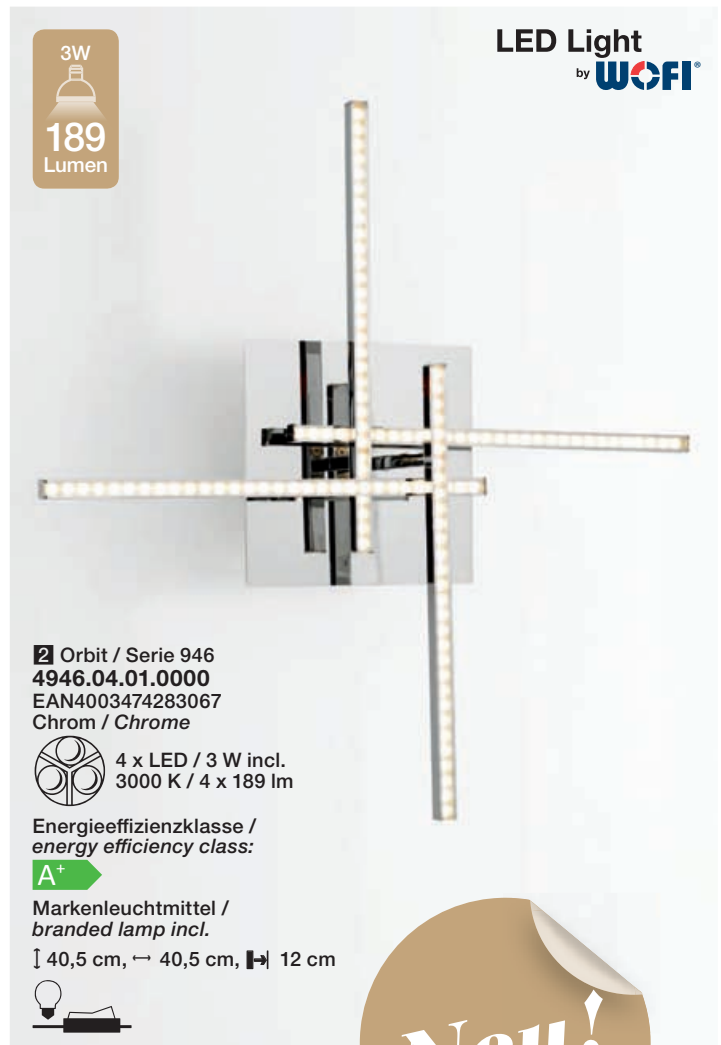
3W
189
Lumen

LED Light
by **WOFI**

2 Orbit / Serie 946
4946.04.01.0000
EAN4003474283067
Chrom / Chrome

 4 x LED / 3 W incl.
3000 K / 4 x 189 lm

Energieeffizienzklasse /
energy efficiency class:
A+

Markenleuchtmittel /
branded lamp incl.
↑ 40,5 cm, ↔ 40,5 cm, ⇨ 12 cm



New!
New!

Faszination Licht

...fascination of light

Die filigranen Leuchten werden zu Lichtblicken des extravaganten Stils

These delicate lights show extravagant style

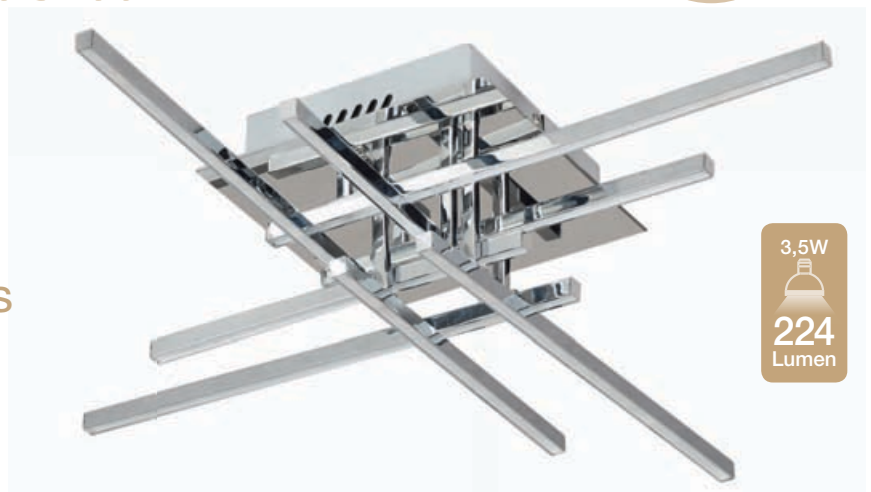

3,5W
224
Lumen

3 Orbit / Serie 946
9946.08.01.0000
EAN4003474283074
Chrom / Chrome

 8 x LED / 3,5 W incl.
3000 K / 8 x 224 lm

Energieeffizienzklasse /
energy efficiency class:
A+

Markenleuchtmittel /
branded lamp incl.
↑ 56 cm, ↔ 56 cm, ⇩ 13 cm

Dimmbar mittels geeignetem
Wanddimmer / dimmable by
suitable wall dimmer





4 Orbit / Serie 946
3946.01.01.0000
 EAN4003474283043
 Chrom / Chrome

 1 x LED / 10 W incl.
 3000 K / 1 x 620 lm

Energieeffizienzklasse /
 energy efficiency class:

A

Markenleuchtmittel /
 branded lamp incl.

∫ 135 cm, ⇨ 65 cm



10W

620
 Lumen

5 Orbit / Serie 946
8946.01.01.0000
 EAN4003474283050
 Chrom / Chrome

 1 x LED / 8 W incl.
 3000 K / 1 x 511 lm

Energieeffizienzklasse /
 energy efficiency class:

A

Markenleuchtmittel /
 branded lamp incl.

∫ 67 cm, ⇨ 50 cm



8W

511
 Lumen

1 Benett / Serie 557
3557.05.01.0000
EAN4003474279480
Chrom / Chrome



24 W LED incl.
3000 K / 1900 lm

Energieeffizienzklasse /
energy efficiency class:

A

Markenleuchtmittel /
branded lamp incl.

↑ 190 cm, ↳ 62 cm, ↗ 52 cm

3-Stufen dimmbar
3-step dimmable



24W
1900
Lumen



LED Light
by WOFI



Neu!
New!



9,5W
700
Lumen

2 Benett / Serie 557
3557.01.01.1100
EAN4003474281902
Chrom / Chrome



1 x LED / 9,5 W incl.
3000 K / 1 x 700 lm

Energieeffizienzklasse /
energy efficiency class:

A

Markenleuchtmittel /
branded lamp incl.

Ø 9 cm, ↑ 110 cm





39W
2800
Lumen

4 Benett / Serie 557
9557.10.01.0000
EAN4003474283197
Chrom / Chrome



39 W LED incl.
3000 K / 2800 lm

Energieeffizienzklasse /
energy efficiency class:

A

Markenleuchtmittel /
branded lamp incl.

↔ 150 cm, ↓ 24 cm

Licht für Individualisten

...Lights for individualists



7W
530
Lumen

3 Benett / Serie 557
3557.01.01.0850
EAN4003474281896
Chrom / Chrome



1 x LED / 7 W incl.
3000 K / 1 x 530 lm

Energieeffizienzklasse /
energy efficiency class:

A⁺

Markenleuchtmittel /
branded lamp incl.

Ø 9 cm, ↑ 85 cm



3,7W
280
Lumen

5 Benett / Serie 557
3557.01.01.0450
EAN4003474281889
Chrom / Chrome



1 x LED / 3,7 W incl.
3000 K / 1 x 280 lm

Energieeffizienzklasse /
energy efficiency class:

A⁺

Markenleuchtmittel /
branded lamp incl.

Ø 9 cm, ↑ 45 cm



32W
2200
Lumen



1 Benett / Serie 557
9557.16.01.0000
EAN4003474283203
Chrom / Chrome

 32 W LED incl.
3000 K / 2200 lm

Energieeffizienzklasse /
energy efficiency class:

A

Markenleuchtmittel /
branded lamp incl.

Ø 100 cm, H 10 cm

New!
New!

Charmantes Design

...charming design



2 Benett / Serie 557
9557.08.01.0000
EAN4003474291192
Chrom / Chrome

 20 W LED incl.
3000 K / 1400 lm

Energieeffizienzklasse /
energy efficiency class:

A

Markenleuchtmittel /
branded lamp incl.

Ø 60 cm, H 7 cm

20W
1400
Lumen

22W
1600
Lumen



Neu!

Neu!

*Designs, die das Leben
schöner machen*

...designs that make life more beautiful

I Vela / Serie 543
9543.01.01.0000
EAN4003474279473
Chrom / Chrome



1 x LED / 22 W incl.
3000 K / 1 x 1600 lm

Energieeffizienzklasse /
energy efficiency class:

A

Markenleuchtmittel /
branded lamp incl.

Ø 50 cm, ↑ 30 cm

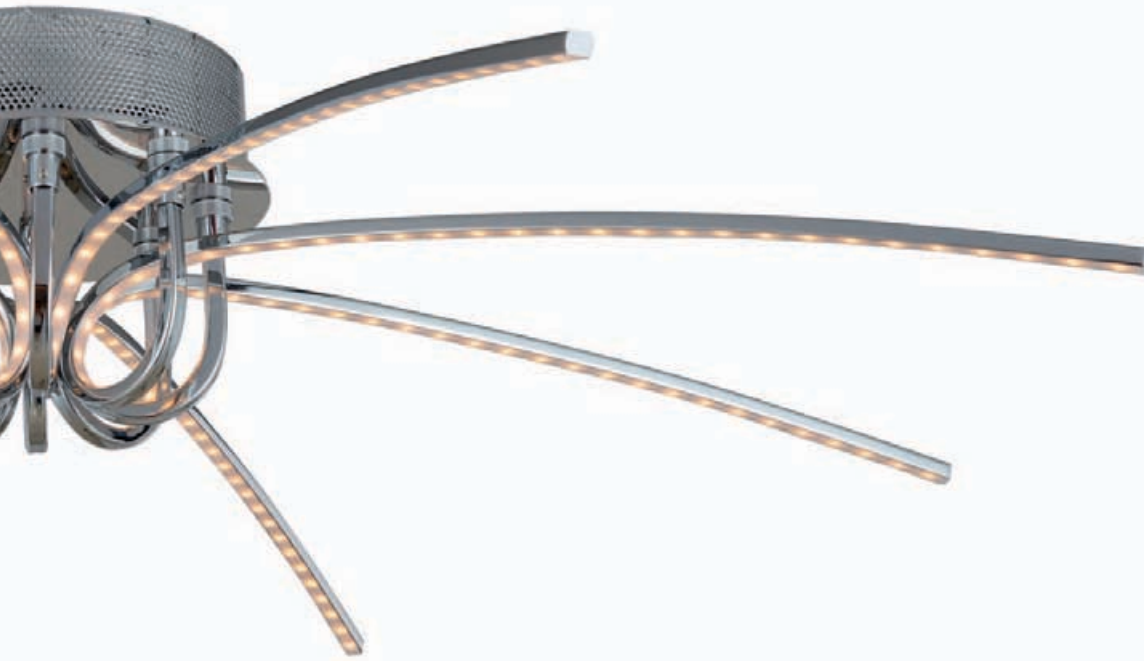

Deckenleuchten mit Ausstrahlung

...ceiling lights with a radiant personality

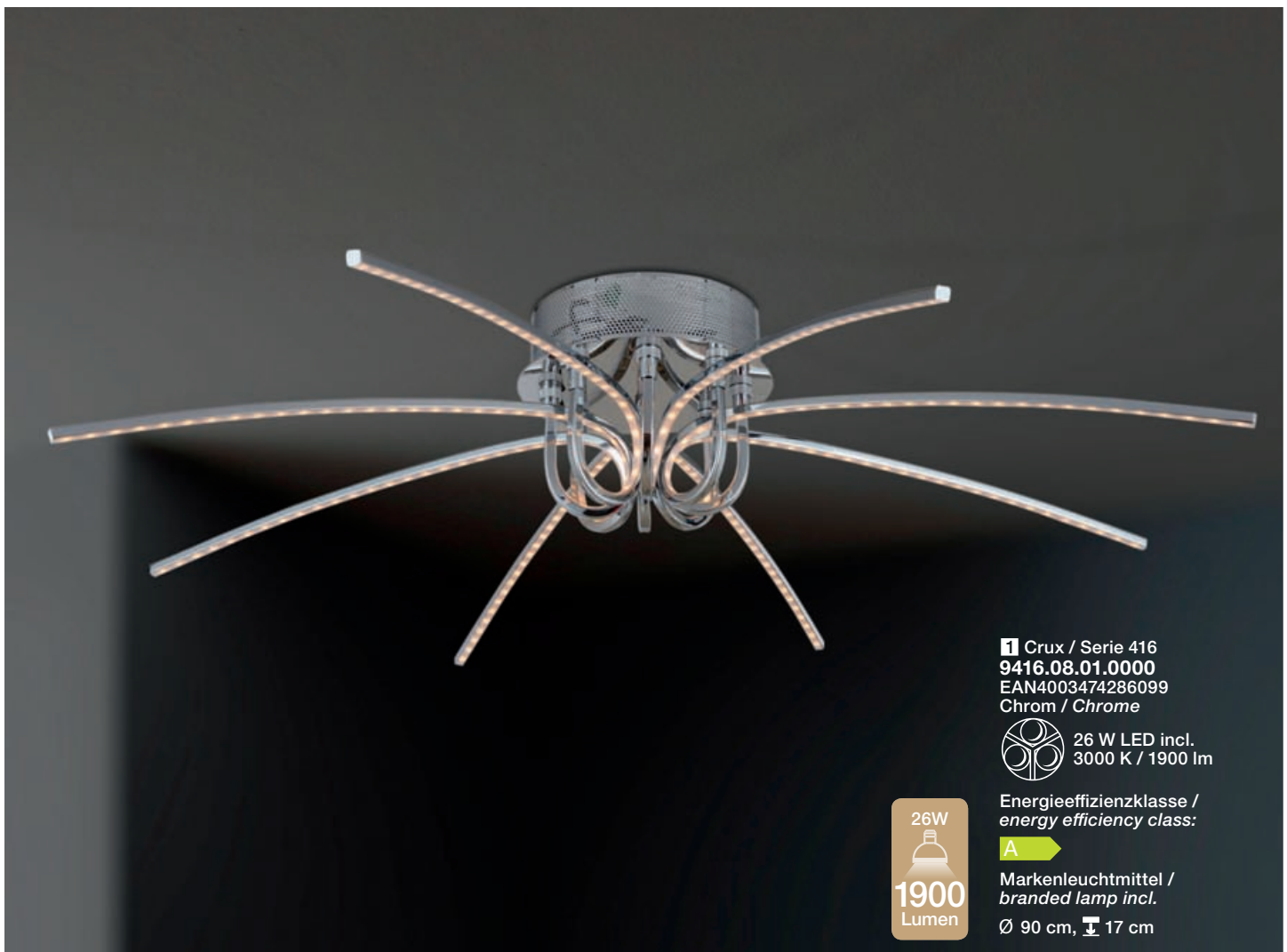

1 Crux / Serie 416
9416.08.01.0000
EAN4003474286099
Chrom / Chrome



26 W LED incl.
3000 K / 1900 lm

Energieeffizienzklasse /
energy efficiency class:

A

Markenleuchtmittel /
branded lamp incl.

Ø 90 cm, H 17 cm

26W

1900
Lumen

21W

1700
Lumen



1 Xenia / Serie 037
9037.06.01.0000
EAN4003474286914
Chrom / Chrome

 21 W LED incl.
3000 K / 1700 lm

Energieeffizienzklasse /
energy efficiency class:

A

Markenleuchtmittel /
branded lamp incl.

Ø 80 cm,  14 cm

New!

New!

20W

1500
Lumen

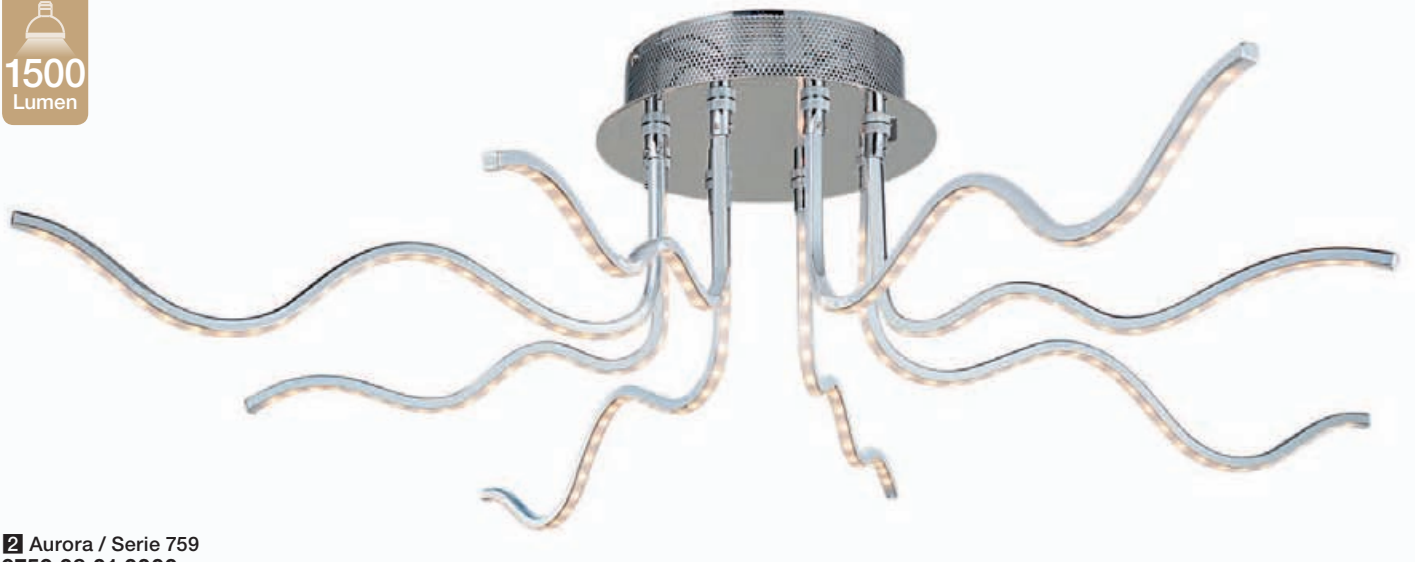

2 Aurora / Serie 759
9759.08.01.0000
EAN4003474286907
Chrom / Chrome

 20 W LED incl.
3000 K / 1500 lm

Energieeffizienzklasse /
energy efficiency class:

A

Markenleuchtmittel /
branded lamp incl.

Ø 90 cm,  23 cm

1 Lex / Serie 024
6024.01.01.0000
EAN4003474286112
Chrom / Chrome



1 x LED / 27 W incl.
3000 K / 1 x 1890 lm

Energieeffizienzklasse /
energy efficiency class:

A

Markenleuchtmittel /
branded lamp incl.

↔ 80 cm, ↑ 150 cm

27W



1890
Lumen



2 Lex / Serie 024
9024.01.01.0000
EAN4003474286136
Chrom / Chrome



1 x LED / 27 W incl.
3000 K / 1 x 1890 lm

Energieeffizienzklasse /
energy efficiency class:

A

Markenleuchtmittel /
branded lamp incl.

↔ 80 cm, ↑ 36 cm

27W



1890
Lumen

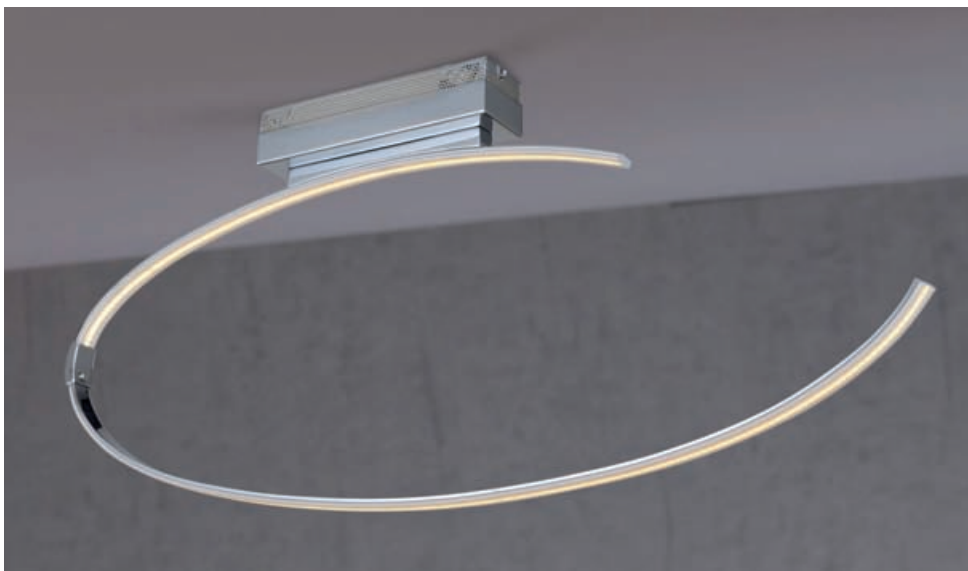

Ära der Eleganz

...time for elegance

Neu!

Neu!

Lex / Serie 024
8024.01.01.0000
EAN4003474286129
Chrom / Chrome



1 x LED / 11 W incl.
3000 K / 1 x 800 lm

Energieeffizienzklasse /
energy efficiency class:

A

Markenleuchtmittel /
branded lamp incl.

↔ 70 cm, ↑ 35 cm



3-Stufen dimmbar
3-step dimmable

11W



800
Lumen

1 Style / Serie 922
6922.03.01.0000
 EAN4003474289304
 Chrom / Chrome



40 W LED incl.
 3000 K / 2700 lm

Energieeffizienzklasse /
 energy efficiency class:

A

Markenleuchtmittel /
 branded lamp incl.

Ø 55 cm, ↑ 150 cm

Dimmbar mittels geeignetem
 Wanddimmer / dimmable by
 suitable wall dimmer



LED Light
 by **WOFI**

40W

2700
 Lumen

New!

New!

Stilvoll, innovativ & effizient

Ausdrucksstarke Leuchten für
 leidenschaftliche Design-Fans.

Stylish, innovative & efficient

The perfect light for those
 passionate about design.



2 Style / Serie 922
8922.01.01.0350
 EAN4003474282824
 Chrom / Chrome



1 x LED / 11 W incl.
 3000 K / 1 x 850 lm

Energieeffizienzklasse /
 energy efficiency class:

A

Markenleuchtmittel /
 branded lamp incl.

Ø 36 cm, ↑ 37,5 cm, ↔ 10 cm



3-Stufen dimmbar
 3-step dimmable

11W

850
 Lumen

LED Light
by **WOFI**

1 Laval / Serie 369
9369.01.01.0000
EAN4003474286839
Chrom / Chrome



1 x LED / 16 W incl.
3000 K / 1 x 1200 lm

Energieeffizienzklasse /
energy efficiency class:

A

Markenleuchtmittel /
branded lamp incl.

Ø 25 cm, ↑ 38 cm



Neu!

Neu!

Innovationen für Morgen
...innovations for tomorrow



1 Cosmo / Serie 960
4960.01.01.0000
 EAN4003474263403
 Chrom / Chrome

LED Light
 by **WOFI**



1 x LED / 10,8 W incl.
 3000 K / 1 x 970 lm

Energieeffizienzklasse /
 energy efficiency class:

A+

Ø 31 cm, H 6 cm

10,8W

970
 Lumen

Machen überall eine gute Figur

Man nehme: pures Design und modernste Lichttechnik. Schon wird aus einer neuen Leuchte eine runde Sache!

Always a good look

Take pure design and the latest lighting technology to create a new lamp of great style.



10,8W

970
 Lumen

2 Cosmo / Serie 960
8960.01.01.0300
 EAN4003474261188
 Chrom / Chrome



1 x LED / 10,8 W incl.
 3000 K / 1 x 970 lm

Energieeffizienzklasse /
 energy efficiency class:

A+

Ø 30,5 cm, ↑ 31,5 cm



3-Stufen dimmbar
 3-step dimmable

Strahlender Looping

...Bright looping

18W

1600
 Lumen

 Cosmo / Serie 960
8960.01.01.0500
 EAN4003474261195
 Chrom / Chrome

 1 x LED / 18 W incl.
 3000 K / 1 x 1600 lm

Energieeffizienzklasse /
 energy efficiency class:

A⁺

Ø 50 cm, ↑ 51 cm

  3-Stufen dimmbar
 3-step dimmable

LED Light
by **WOFI**



1 Avance / Serie 831
9831.06.01.0000
EAN4003474269184
Chrom / Chrome



6 x LED / 4,8 W incl.
3000 K / 6 x 410 lm

Energieeffizienzklasse /
energy efficiency class:

A+

Markenleuchtmittel /
branded lamp incl.

↔ 161 cm, ⊥ 20 cm

Glas / Glass: 6271

↔ 14 cm, ⊥ 6,4 cm

Dimmbar mittels ge-
eignetem Wanddimmer /
dimmable by suitable
wall dimmer



4,8W



410
Lumen



2 Avance / Serie 831
7831.04.01.0000
EAN4003474274201
Chrom / Chrome



4 x LED / 4,8 W incl.
3000 K / 4 x 410 lm

Energieeffizienzklasse /
energy efficiency class:

A+

Markenleuchtmittel /
branded lamp incl.

⊥ 150 cm, ↔ 103 cm

Glas / Glass: 6271

↔ 14 cm, ⊥ 6,4 cm

Dimmbar mittels ge-
eignetem Wanddimmer /
dimmable by suitable
wall dimmer



6,4 cm

14 cm

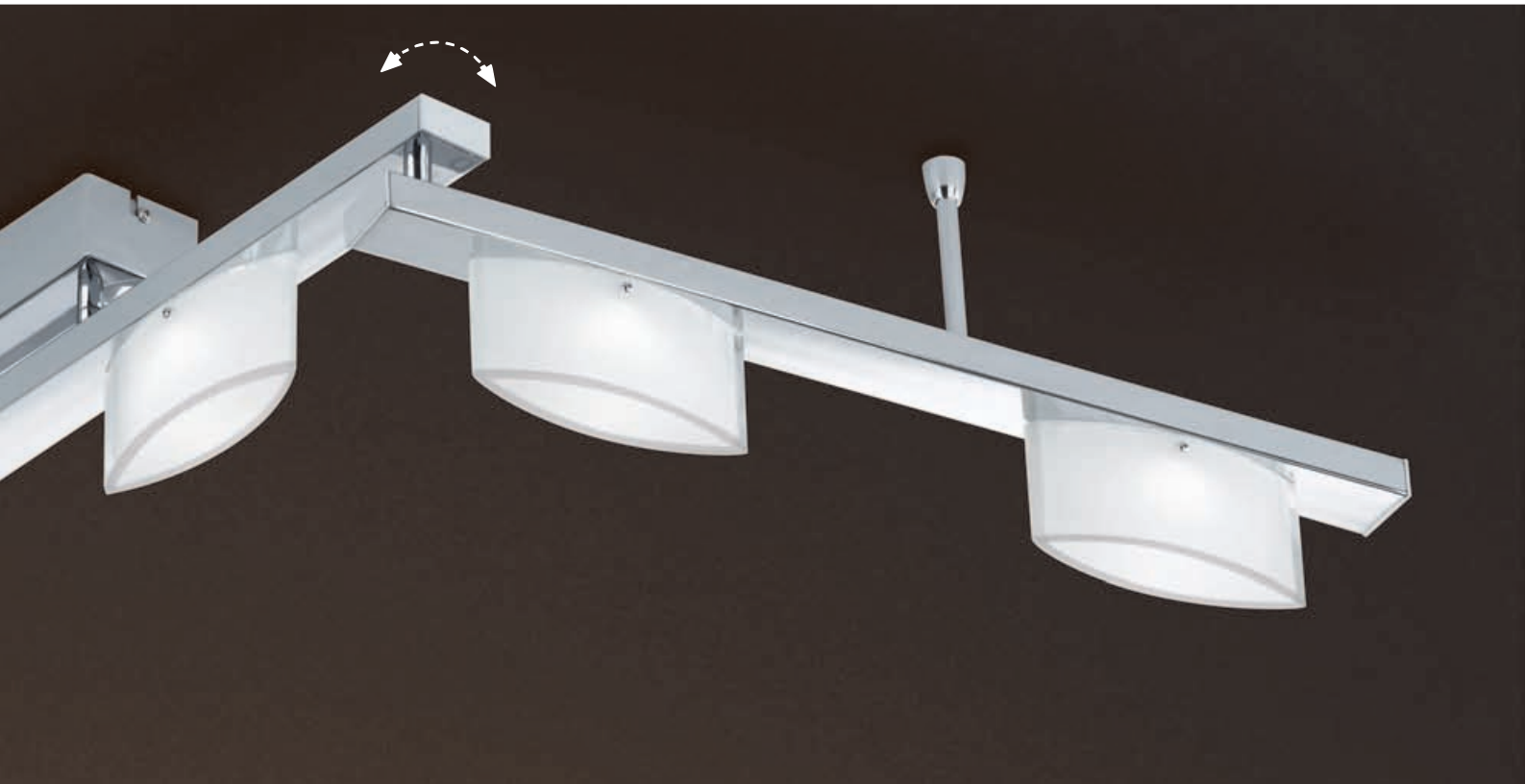

Ganz schön flexibel

...Light without limits

4,8W

410
 Lumen

LED Light
 by **WOFI**



Markenleuchtmittel /
 branded lamp incl.

↔ 103 cm, ⊥ 15 cm

Glas / Glass: 6271

↔ 14 cm, ⊥ 6,4 cm

3 Avance / Serie 831
9831.04.01.0000
 EAN4003474269177
 Chrom / Chrome



4 x LED / 4,8 W incl.
 3000 K / 4 x 410 lm

Energieeffizienzklasse /
 energy efficiency class:

A+

Dimmbar mittels ge-
 eignetem Wanddimmer /
 dimmable by suitable
 wall dimmer



4,8W

410
 Lumen



21,6W
2000
Lumen

1 Toulouse / Serie 997
3997.01.64.0000
EAN4003474291550
Nickel-matt /
Nickel matt finished



1 x LED / 21,6 W incl.
3000 K / 1 x 2000 lm

Energieeffizienzklasse /
energy efficiency class:

A+

Markenleuchtmittel /
branded lamp incl.

Ø 25 cm, ↑ 140 cm



Leuchterschirm exkl. /
lampshade excl.

25 cm



2 Toulouse / Serie 997
4111
EAN4003474164281
Weiß / White
Ø 45 cm, ↑ 22 cm



3 Toulouse / Serie 997
4142
EAN4003474292403
Braun / Brown
Ø 45 cm, ↑ 22 cm



4 Toulouse / Serie 997
3997.01.32.0000
EAN4003474292588
Messing-matt /
Brass matt finished



1 x LED / 21,6 W incl.
2700 K / 1 x 2000 lm

Energieeffizienzklasse /
energy efficiency class:

A+

Markenleuchtmittel /
branded lamp incl.

Ø 25 cm, ↑ 140 cm



Leuchterschirm exkl. /
lampshade excl.

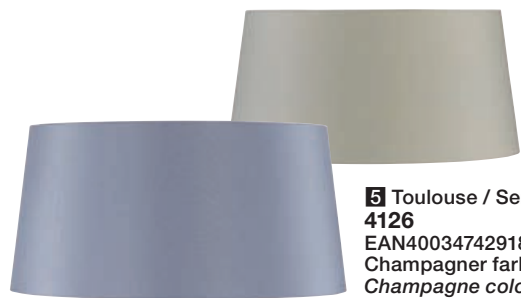

6 Toulouse / Serie 997
4113
EAN4003474291727
Grau / Grey
Ø 45 cm, ↑ 22 cm

5 Toulouse / Serie 997
4126
EAN4003474291840
Champagner farbig /
Champagne colour
Ø 45 cm, ↑ 22 cm

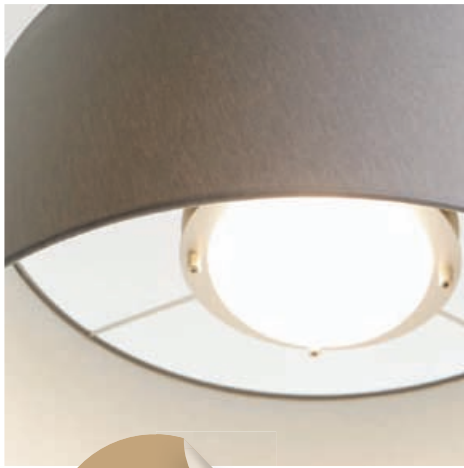

Neu!
New!



2 Toulouse / Serie 997
6997.01.64.0000
EAN4003474291574
Nickel-matt / *Nickel matt finished*

 1 x LED / 21,6 W incl.
3000 K / 1 x 2000 lm

Energieeffizienzklasse /
energy efficiency class:

A⁺

Markenleuchtmittel /
branded lamp incl.

Ø 18 cm, ↓ 150 cm

Dimmbar mittels geeignetem Wanddimmer /
dimmmable by suitable wall dimmer



Leuchtschirm exkl. /
lampshade excl.

21,6W

2000
Lumen

1 Toulouse / Serie 997
6997.01.32.0000
EAN4003474292595
Messing-matt /
Brass matt finished

 1 x LED / 21,6 W incl.
2700 K / 1 x 2000 lm

Energieeffizienzklasse /
energy efficiency class:

A⁺

Markenleuchtmittel /
branded lamp incl.

Ø 18 cm, ↓ 150 cm

Dimmbar mittels geeignetem Wanddimmer /
dimmmable by suitable wall dimmer



Leuchtschirm exkl. /
lampshade excl.

3 Toulouse / Serie 997
4116
EAN4003474291758
Grau / *Grey*
Ø 45 cm, ↓ 22 cm

4 Toulouse / Serie 997
4138
EAN4003474292359
Braun / *Brown*
Ø 45 cm, ↓ 22 cm



5 Toulouse / Serie 997
4114
EAN4003474291734
Weiß / *White*
Ø 45 cm, ↓ 22 cm

6 Toulouse / Serie 997
4127
EAN4003474291857
Champagner farbig /
Champagne colour
Ø 45 cm, ↓ 22 cm

21,6W
2000
Lumen



1 Toulouse / Serie 997
7997.01.64.0000
EAN4003474292236
Nickel-matt /
Nickel matt finished

 1 x LED / 21,6 W incl.
3000 K / 1 x 2000 lm

Energieeffizienzklasse /
energy efficiency class:

A+

Markenleuchtmittel /
branded lamp incl.

↓ 150 cm, ↔ 76 cm

Dimmbar mittels geeignetem
Wanddimmer / dimmable by
suitable wall dimmer



Leuchtschirm exkl. /
lampshade excl.



3 Toulouse / Serie 997
4119
EAN4003474291789
Grau / Grey

↔ 100 cm, ↓ 14 cm,
↗ 25 cm



4 Toulouse / Serie 997
4140
EAN4003474292380
Braun / Brown

↔ 100 cm, ↓ 14 cm, ↗ 25 cm



5 Toulouse / Serie 997
4117
EAN4003474291765
Weiß / White

↔ 100 cm, ↓ 14 cm,
↗ 25 cm



6 Toulouse / Serie 997
4128
EAN4003474291864
Champagner farbig /
Champagne colour

↔ 100 cm, ↓ 14 cm, ↗ 25 cm



2 Toulouse / Serie 997
7997.01.32.0000
EAN4003474292601
Messing-matt /
Brass matt finished

 1 x LED / 21,6 W incl.
2700 K / 1 x 2000 lm

Energieeffizienzklasse /
energy efficiency class:

A+

Markenleuchtmittel /
branded lamp incl.

↓ 150 cm, ↔ 76 cm

Dimmbar mittels geeignetem
Wanddimmer / dimmable by
suitable wall dimmer



Leuchtschirm exkl. /
lampshade excl.

LED Light
by **WOFI**13,4W

1200
Lumen**Neu!****Neu!**

18 cm

1 Toulouse / Serie 997**8997.01.64.0000**

EAN4003474291635

Nickel-matt /

Nickel matt finished

1 x LED / 13,4 W incl.
3000 K / 1 x 1200 lmEnergieeffizienzklasse /
energy efficiency class:**A⁺**Markenleuchtmittel /
branded lamp incl.

Ø 18 cm, ↑ 45 cm

Leuchtschirm exkl. /
lampshade excl.**2** Toulouse / Serie 997**8997.01.32.0000**

EAN4003474292618

Messing-matt /

Brass matt finished

1 x LED / 13,4 W incl.
2700 K / 1 x 1200 lmEnergieeffizienzklasse /
energy efficiency class:**A⁺**Markenleuchtmittel /
branded lamp incl.

Ø 18 cm, ↑ 45 cm

Leuchtschirm exkl. /
lampshade excl.

Leuchten mit Charakter

...Lights with character

**3** Toulouse / Serie 997**4120**

EAN4003474291796

Weiß / White

Ø 25 cm, ↑ 18,5 cm

**4** Toulouse / Serie 997**4129**

EAN4003474291871

Champagner farbig /
Champagne colour

Ø 25 cm, ↑ 18,5 cm

**5** Toulouse / Serie 997**4136**

EAN4003474292274

Braun / Brown

Ø 25 cm, ↑ 18,5 cm

**6** Toulouse / Serie 997**4122**

EAN4003474291819

Grau / Grey

Ø 25 cm, ↑ 18,5 cm

Extravaganz in neuer Form

...A new form of extravagance



Neu!

New!

Ein ganz eigener Stil

Mit avantgardistischer Form und Dimmbarkeit setzen Sie beeindruckende Lichtakzente und präsentieren Ihre Räumlichkeit im schönsten Licht.

A style of its own

With its innovative form and by clever dimming you can create impressive lighting accents that show off your living room at its best.



16 cm

21,6W

2000
Lumen

1 Toulouse / Serie 997
9997.01.64.0000
EAN4003474291673
Nickel-matt / Nickel matt finished



1 x LED / 21,6 W incl.
3000 K / 1 x 2000 lm

Energieeffizienzklasse /
energy efficiency class:

A+

Markenleuchtmittel /
branded lamp incl.

Ø 16 cm, ↓ 9 cm

Dimmbar mittels geeignetem Wanddimmer /
dimmable by suitable wall dimmer



Leuchtschirm exkl. /
lampshade excl.

21,6W

2000
Lumen

2 Toulouse / Serie 997
9997.01.32.0000
 EAN4003474292625
 Messing-matt /
 Brass matt finished

 1 x LED / 21,6 W incl.
 2700 K / 1 x 2000 lm

Energieeffizienzklasse /
 energy efficiency class:

A⁺

Markenleuchtmittel /
 branded lamp incl.

Ø 16 cm, ↓ 9 cm

Dimmbar mittels geeignetem
 Wanddimmer / dimmable by
 suitable wall dimmer



Leuchtschirm exkl. /
 lampshade excl.



3 Toulouse / Serie 997
4131
 EAN4003474213729
 Champagner farbig /
 Champagne colour

4 Toulouse / Serie 997
4132
 EAN4003474213743
 Weiß / White

5 Toulouse / Serie 997
4143
 EAN4003474292458
 Braun / Brown



7 Toulouse / Serie 997
4125
 EAN4003474097053
 Grau / Grey

8 Toulouse / Serie 997
4123
 EAN4003474291826
 Weiß / White

9 Toulouse / Serie 997
4144
 EAN4003474292465
 Braun / Brown



6 Toulouse / Serie 997
4134
 EAN4003474291888
 Grau / Grey
 Ø 80 cm, ↓ 15 cm



10 Toulouse / Serie 997
4130
 EAN4003474213712
 Champagner farbig / Champagne colour
 Ø 45 cm, ↓ 15 cm

5W
450
Lumen



3 Class / Serie 450
8450.01.64.0000
EAN4003474271613
Nickel-matt /
Nickel matt finished



1 x LED / 6 W incl.
3000 K / 1 x 500 lm

Energieeffizienzklasse /
energy efficiency class:

A+

Markenleuchtmittel /
branded lamp incl.

Ø 16 cm, ↑ 29 cm

Glas: opal weiß satiniert /
Innenschliff
Glass: opal white satined /
cutline inside
Glas / Glass: 6364,
Ø 16 cm, ↑ 8 cm



6W
500
Lumen

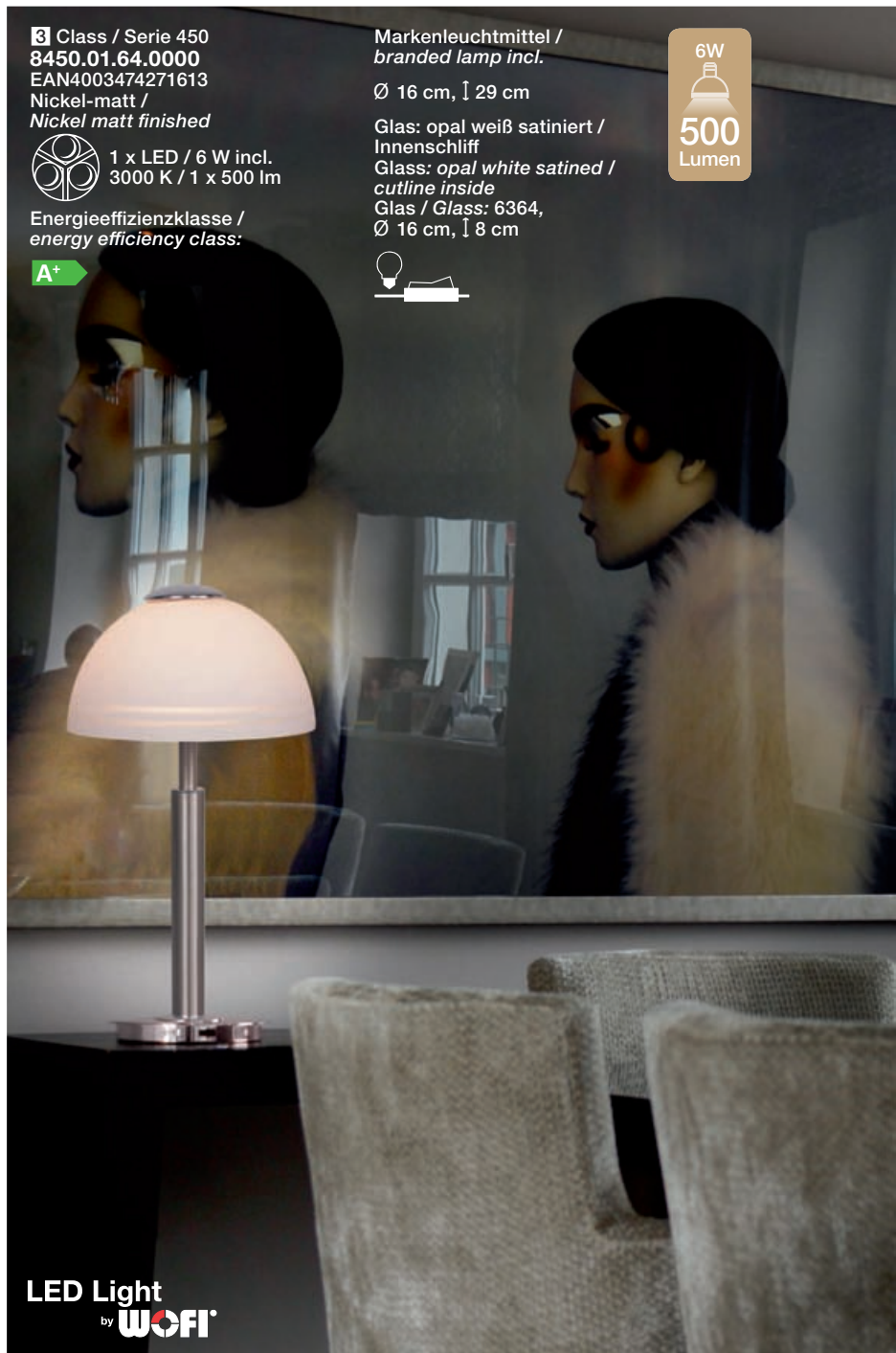

LED Light
by WOFI

1 Class / Serie 450
7450.04.64.0000
EAN4003474270579
Nickel-matt /
Nickel matt finished



4 x LED / 5 W incl.
3000 K / 4 x 450 lm

Energieeffizienzklasse /
energy efficiency class:

A+

Markenleuchtmittel /
branded lamp incl.

→ 121 cm, ↑ 150 cm

Glas: opal weiß satiniert /
Innenschliff
Glass: opal white satined /
cutline inside
Glas / Glass: 6264,
Ø 16 cm, ↑ 8 cm

Dimmbar mittels geeignetem
Wanddimmer / dimmable by
suitable wall dimmer

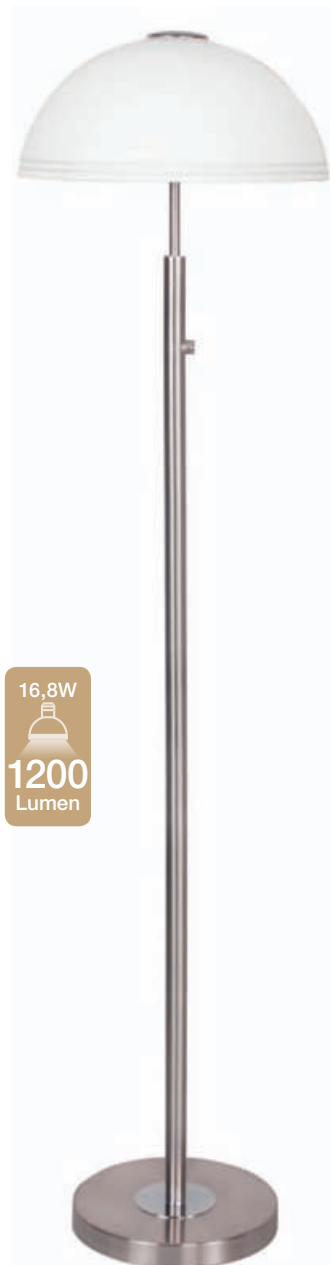

16,8W
1200
Lumen

2 Class / Serie 450
3450.01.64.0000
EAN4003474271606
Nickel-matt /
Nickel matt finished



1 x LED / 16,8 W incl.
3000 K / 1 x 1200 lm

Energieeffizienzklasse /
energy efficiency class:

A

Markenleuchtmittel /
branded lamp incl.

Ø 35 cm, ↑ 141 cm

Glas: opal weiß satiniert /
Innenschliff
Glass: opal white satined /
cutline inside
Glas / Glass: 6262,
Ø 35 cm, ↑ 15 cm



4 Class / Serie 450
8450.01.64.0250
EAN4003474272658
Nickel-matt /
Nickel matt finished



1 x LED / 9,6 W incl.
3000 K / 1 x 900 lm

Energieeffizienzklasse /
energy efficiency class:

A+

Markenleuchtmittel /
branded lamp incl.

Ø 25 cm, ↑ 45 cm

Glas: opal weiß satiniert /
Innenschliff
Glass: opal white satined /
cutline inside
Glas / Glass: 6263,
Ø 25 cm, ↑ 12 cm



9,6W
900
Lumen



*Verleiht jedem
Interieur den
letzten Schliff*
...Gives every interior
a final polish

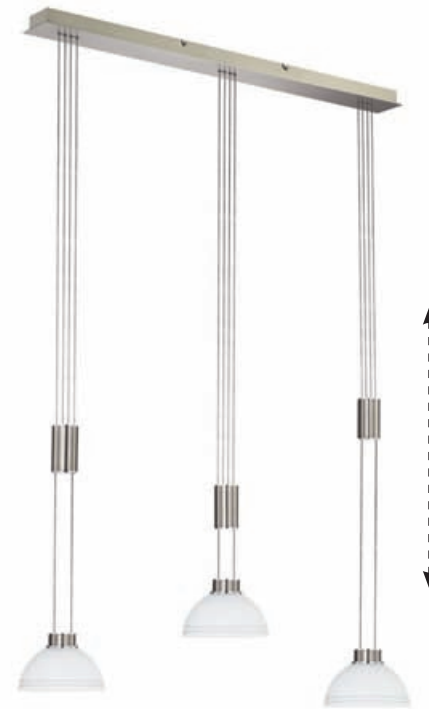

5W
450
Lumen

7 Class / Serie 450
7450.03.64.0000
EAN4003474270586
Nickel-matt /
Nickel matt finished



3 x LED / 5 W incl.
3000 K / 3 x 450 lm

Energieeffizienzklasse /
energy efficiency class:



Markenleuchtmittel /
branded lamp incl.

↔ 86 cm, ↑ 150 cm

Glas: opal weiß satiniert /
Innenschliff
Glass: opal white satined /
cutline inside
Glas / Glass: 6264,
Ø 16 cm, ↑ 8 cm

Dimmbar mittels ge-
eignetem Wanddimmer /
dimnable by suitable
wall dimmer



5 Class / Serie 450
7450.02.64.0000
EAN4003474270593
Nickel-matt /
Nickel matt finished



2 x LED / 5 W incl.
3000 K / 2 x 450 lm

Energieeffizienzklasse /
energy efficiency class:



Markenleuchtmittel /
branded lamp incl.

↔ 48,5 cm, ↑ 150 cm,

Glas: opal weiß satiniert /
Innenschliff

Glass: opal white satined /
cutline inside

Glas / Glass: 6264,
Ø 16 cm, ↑ 8 cm

Dimmbar mittels geeignetem
Wanddimmer / dimmable by
suitable wall dimmer



5W
450
Lumen

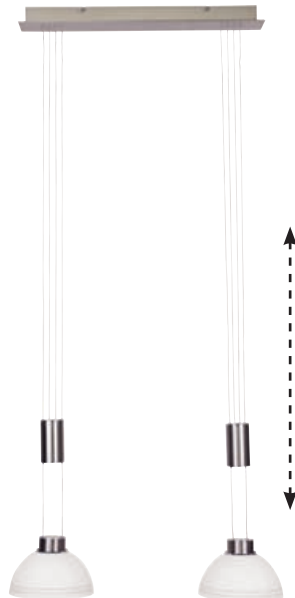

6 Class / Serie 450
6450.01.64.0250
EAN4003474273686
Nickel-matt /
Nickel matt finished



1 x LED / 10 W incl.
3000 K / 1 x 900 lm

Energieeffizienzklasse /
energy efficiency class:



Markenleuchtmittel /
branded lamp incl.

Ø 25 cm, ↑ 150 cm

Glas: opal weiß satiniert /
Innenschliff

Glass: opal white satined /
cutline inside

Glas / Glass: 6550,
Ø 25 cm, ↑ 11,9 cm

Dimmbar mittels geeignetem
Wanddimmer / dimmable by
suitable wall dimmer



10W
900
Lumen



1 Class / Serie 450
7450.03.32.0000
 EAN4003474273532
 Messing-matt /
 Brass matt finished



3 x LED / 5 W incl.
 3000 K / 3 x 450 lm

Energieeffizienzklasse /
 energy efficiency class:

A+

Markenleuchtmittel /
 branded lamp incl.

→ 86 cm, ↓ 150 cm

Glas: opal weiß satiniert /
 Innenschliff
 Glass: opal white satined /
 cutline inside
 Glas / Glass: 6264
 Ø 16 cm, ↓ 8 cm

Dimmbar mittels geeignetem
 Wanddimmer / dimmable by
 suitable wall dimmer



5W

450
 Lumen



*Leuchten für mehr
 Behaglichkeit*
 ...Lamps to increase your comfort

LED Light
 by **WOFI**



2 Class / Serie 450
8450.01.32.0250
 EAN4003474273549
 Messing-matt /
 Brass matt finished



1 x LED / 9,6 W incl.
 3000 K / 1 x 900 lm

Energieeffizienzklasse /
 energy efficiency class:

A+

Markenleuchtmittel /
 branded lamp incl.

Ø 25 cm, ↓ 45 cm

Glas: opal weiß satiniert /
 Innenschliff
 Glass: opal white satined /
 cutline inside
 Glas / Glass: 6263,
 Ø 25 cm, ↓ 12 cm

9,6W

900
 Lumen



3 Class / Serie 450
8450.01.32.0000
 EAN4003474273648
 Messing-matt /
 Brass matt finished



1 x LED / 6 W incl.
 3000 K / 1 x 500 lm

Energieeffizienzklasse /
 energy efficiency class:

A+

Markenleuchtmittel /
 branded lamp incl.

Ø 16 cm, ↓ 29 cm

Glas: opal weiß satiniert /
 Innenschliff
 Glass: opal white satined /
 cutline inside
 Glas / Glass: 6364
 Ø 16 cm, ↓ 8 cm

6W

500
 Lumen



4 Class / Serie 450
6450.01.32.0250
 EAN4003474273693
 Messing-matt / Brass matt finished



1 x LED / 10 W incl.
 3000 K / 1 x 900 lm

Energieeffizienzklasse /
 energy efficiency class:

A+

Markenleuchtmittel /
 branded lamp incl.

Ø 25 cm, ↑ 150 cm

Glas: opal weiß satiniert /
 Innenschliff

Glass: opal white satined /
 cutline inside

Glas / Glass: 6550
 Ø 25 cm, ↑ 11,9 cm

Dimmbar mittels geeignetem
 Wanddimmer / dimmable by suitable
 wall dimmer



10W

900
 Lumen

Der Glasschliff verrät die
 Liebe zum Detail

The facet cutting shows the
 attention to detail

5W

450
 Lumen

5 Class / Serie 450
7450.02.32.0000
 EAN4003474273525
 Messing-matt / Brass matt finished



2 x LED / 5 W incl.
 3000 K / 2 x 450 lm

Energieeffizienzklasse /
 energy efficiency class:

A+

Markenleuchtmittel /
 branded lamp incl.

↔ 48,5 cm, ↑ 150 cm

Glas: opal weiß satiniert /
 Innenschliff

Glass: opal white satined /
 cutline inside

Glas / Glass: 6264
 Ø 16 cm, ↑ 8 cm

Dimmbar mittels geeignetem
 Wanddimmer / dimmable by
 suitable wall dimmer

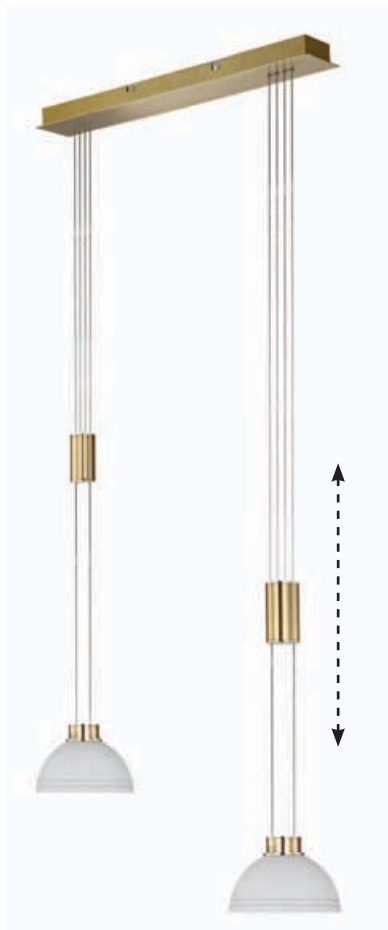

6 Class / Serie 450
3450.01.32.0000
 EAN4003474273518
 Messing-matt /
 Brass matt finished



1 x LED / 16,8 W incl.
 3000 K / 1 x 1200 lm

Energieeffizienzklasse /
 energy efficiency class:

A

Markenleuchtmittel /
 branded lamp incl.

Ø 35 cm, ↑ 141 cm

Glas: opal weiß satiniert /
 Innenschliff

Glass: opal white satined /
 cutline inside

Glas / Glass: 6262
 Ø 35 cm, ↑ 15 cm

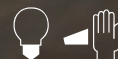

16,8W

1200
 Lumen

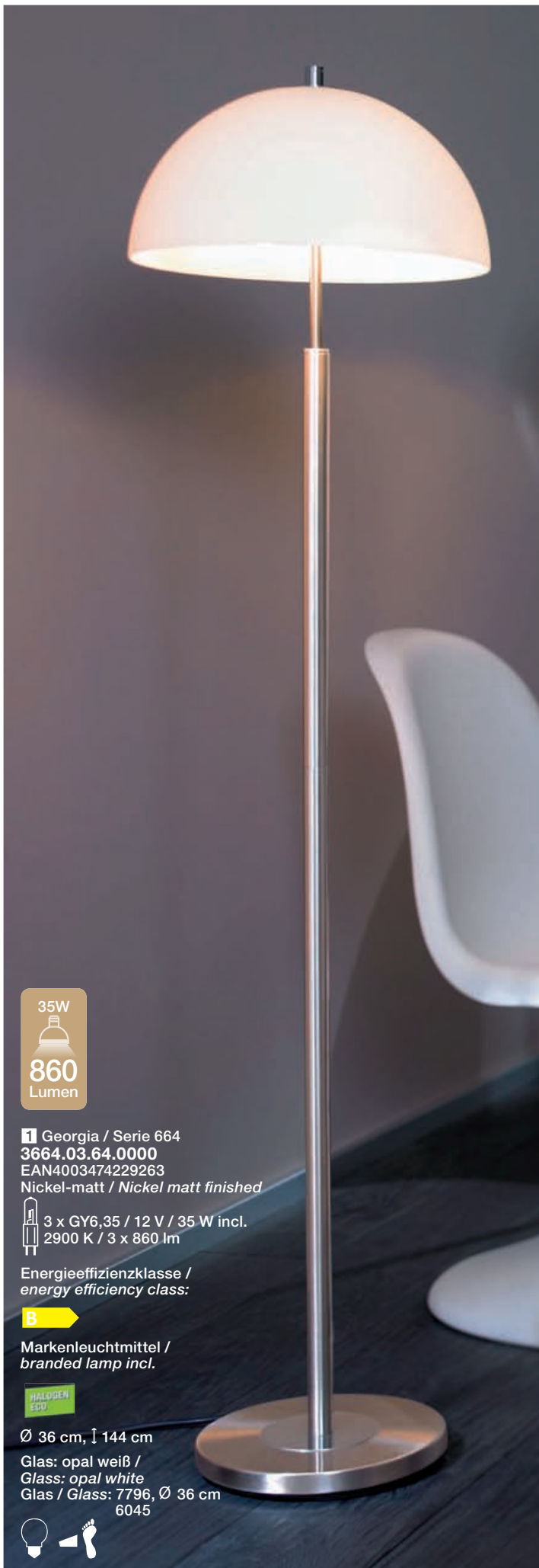

35W
860
Lumen

1 Georgia / Serie 664
3664.03.64.0000
EAN4003474229263
Nickel-matt / *Nickel matt finished*

 3 x GY6,35 / 12 V / 35 W incl.
2900 K / 3 x 860 lm

Energieeffizienzklasse /
energy efficiency class:

B

Markenleuchtmittel /
branded lamp incl.



Ø 36 cm, ↑ 144 cm

Glas: opal weiß /
Glass: opal white
Glas / Glass: 7796, Ø 36 cm
6045



2 Georgia / Serie 664
7664.04.64.0000
EAN4003474201443
Nickel-matt /
Nickel matt finished

 4 x GY6,35 / 12 V / 35 W incl.
2900 K / 4 x 860 lm

Energieeffizienzklasse /
energy efficiency class:

B

Markenleuchtmittel /
branded lamp incl.



↑ 150 cm, ↔ 110 cm

Glas: opal weiß /
Glass: opal white
Glas / Glass: 7766, Ø 14 cm /
6045, Ø 2,6 cm

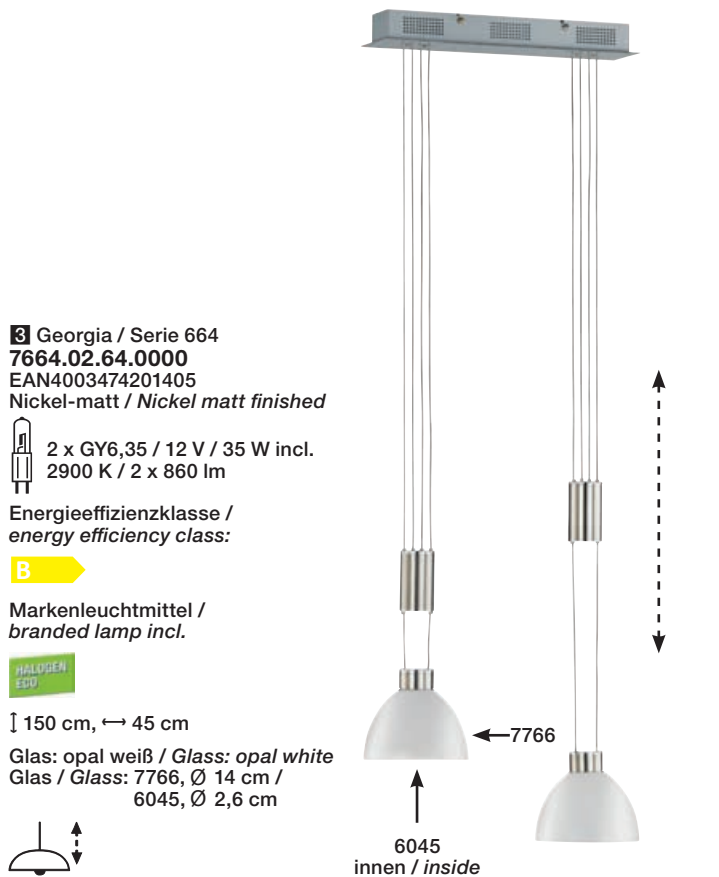

3 Georgia / Serie 664
7664.02.64.0000
EAN4003474201405
Nickel-matt / *Nickel matt finished*

 2 x GY6,35 / 12 V / 35 W incl.
2900 K / 2 x 860 lm

Energieeffizienzklasse /
energy efficiency class:

B

Markenleuchtmittel /
branded lamp incl.



↑ 150 cm, ↔ 45 cm

Glas: opal weiß / *Glass: opal white*
Glas / Glass: 7766, Ø 14 cm /
6045, Ø 2,6 cm



← 7766

↑ 6045
innen / inside



4 Georgia / Serie 664
8664.01.64.0500
 EAN4003474254333
 Nickel-matt /
 Nickel matt finished

1 x GY6,35 / 12 V / 35 W incl.
 2900 K / 1 x 860 lm

Energieeffizienzklasse /
 energy efficiency class:



Markenleuchtmittel /
 branded lamp incl.



Ø 14 cm, ↑ 29 cm

Glas: opal weiß /
 Glass: opal white
 Glas / Glass: 6058, Ø 14 cm
 6045



6 Georgia / Serie 664
6664.01.64.0000
 EAN4003474201368
 Nickel-matt /
 Nickel matt finished

1 x GY6,35 / 12 V / 60 W incl.
 3000 K / 1 x 1650 lm

Energieeffizienzklasse /
 energy efficiency class:



Markenleuchtmittel /
 branded lamp incl.



Ø 24,5 cm, ↑ 150 cm

Glas: opal weiß /
 Glass: opal white
 Glas / Glass: 7765, Ø 25 cm
 6045

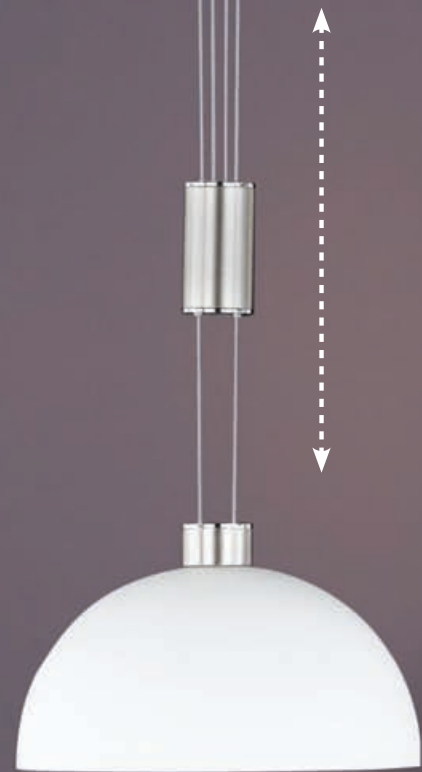

5 Georgia / Serie 664
8664.03.64.0000
 EAN4003474228525
 Nickel-matt /
 Nickel matt finished

3 x GY6,35 / 12 V / 25 W incl.
 2800 K / 3 x 500 lm

Energieeffizienzklasse /
 energy efficiency class:



Markenleuchtmittel /
 branded lamp incl.



Ø 25 cm, ↑ 48 cm

Glas: opal weiß /
 Glass: opal white
 Glas / Glass: 7764, Ø 25 cm
 6045



5W
430
Lumen

1 Casa / Serie 453
5453.06.54.0000
EAN4003474289953
Nickel-matt / Chrom /
Nickel matt finished / Chrome

 6 x LED / 5 W incl.
3000 K / 6 x 430 lm

Energieeffizienzklasse /
energy efficiency class:

A+

Markenleuchtmittel /
branded lamp incl.

Ø 50 cm, ↓ 150 cm

Glas: opal weiß
Glass: opal white
Glas / Glass: 7244,
Ø 8,5 cm, ↓ 8,8 cm

New!
New!



2 Casa / Serie 453
9453.06.54.0000
EAN4003474289960
Nickel-matt / Chrom /
Nickel matt finished / Chrome

 6 x LED / 5 W incl.
3000 K / 6 x 430 lm

Energieeffizienzklasse /
energy efficiency class:

A+

Markenleuchtmittel / branded lamp incl.

Ø 50 cm, ↓ 46 cm

Glas: opal weiß
Glass: opal white
Glas / Glass: 7244, Ø 8,5 cm, ↓ 8,8 cm



Angenehmes Licht und klassisches Design
für stimmungsvolles Wohnambiente!

A blend of subtle lighting and classic design
to create that special mood!

3 Casa / Serie 453
8453.03.54.0000
EAN4003474289922
Nickel-matt / Chrom /
Nickel matt finished / Chrome

 3 x LED / 5 W incl.
3000 K / 3 x 430 lm

Markenleuchtmittel /
branded lamp incl.

Ø 36,5 cm, ↓ 58 cm

Glas: opal weiß
Glass: opal white
Glas / Glass: 7244,
Ø 8,5 cm, ↓ 8,8 cm

Energieeffizienzklasse /
energy efficiency class:

A+





5W
430
Lumen

4 Casa / Serie 453
3453.03.54.0000
EAN4003474289946
Nickel-matt / Chrom /
Nickel matt finished / Chrome

 3 x LED / 5 W incl.
3000 K / 3 x 430 lm

Energieeffizienzklasse /
energy efficiency class:

A⁺

Markenleuchtmittel /
branded lamp incl.

Ø 46,5 cm, ↑ 160 cm

Glas: opal weiß
Glass: opal white
Glas / Glass: 7244,
Ø 8,5 cm, ↑ 8,8 cm



5 Casa / Serie 453
4453.03.54.0000
EAN4003474289885
Nickel-matt / Chrom /
Nickel matt finished / Chrome

 3 x LED / 5 W incl.
3000 K / 3 x 430 lm

Energieeffizienzklasse /
energy efficiency class:

A⁺

Markenleuchtmittel /
branded lamp incl.

↑ 31,5 cm, ↔ 26 cm, ⇨ 21,5 cm

Glas: opal weiß
Glass: opal white
Glas / Glass: 7244,
Ø 8,5 cm, ↑ 8,8 cm



Klassische Momente

...Classical moments



6 Casa / Serie 453
8453.01.54.0000
EAN4003474289915
Nickel-matt / Chrom /
Nickel matt finished / Chrome

 1 x LED / 5 W incl.
3000 K / 1 x 430 lm

Energieeffizienzklasse /
energy efficiency class:

A⁺

Markenleuchtmittel /
branded lamp incl.

↑ 38 cm, ↔ 24 cm

Glas: opal weiß
Glass: opal white
Glas / Glass: 7244, Ø 8,5 cm, ↑ 8,8 cm



5W
430
Lumen

New!
New!



1 Casa / Serie 453
9453.06.32.0000
EAN4003474291529
Messing-matt /
Brass matt finished



6 x LED / 5 W incl.
2700 K / 6 x 430 lm

Energieeffizienzklasse /
energy efficiency class:

A+

Markenleuchtmittel /
branded lamp incl.

Ø 50 cm, ↓ 46 cm

Glas: opal weiß

Glass: opal white

Glas / Glass: 7244, Ø 8,5 cm, ↓ 8,8 cm



2 Casa / Serie 453
5453.06.32.0000
EAN4003474291499
Messing-matt /
Brass matt finished



6 x LED / 5 W incl.
2700 K / 6 x 430 lm

Energieeffizienzklasse /
energy efficiency class:

A+

Markenleuchtmittel /
branded lamp incl.

Ø 50 cm, ↓ 150 cm

Glas: opal weiß

Glass: opal white

Glas / Glass: 7244, Ø 8,5 cm, ↓ 8,8 cm



3 Casa / Serie 453
8453.03.32.0000
EAN4003474291512
Messing-matt /
Brass matt finished



3 x LED / 5 W incl.
2700 K / 3 x 430 lm

Energieeffizienzklasse /
energy efficiency class:

A+

Markenleuchtmittel /
branded lamp incl.

Ø 36,5 cm, ↓ 58 cm

Glas: opal weiß

Glass: opal white

Glas / Glass: 7244, Ø 8,5 cm, ↓ 8,8 cm





5W
430
Lumen

4 Casa / Serie 453
3453.03.32.0000
EAN4003474291475
Messing-matt /
Brass matt finished

 3 x LED / 5 W incl.
2700 K / 3 x 430 lm

Energieeffizienzklasse /
energy efficiency class:

A+

Markenleuchtmittel /
branded lamp incl.

∅ 46,5 cm, ↑ 160 cm

Glas: opal weiß
Glass: opal white
Glas / Glass: 7244, ∅ 8,5 cm, ↑ 8,8 cm



5 Casa / Serie 453
4453.03.32.0000
EAN4003474291482
Messing-matt /
Brass matt finished

 3 x LED / 5 W incl.
2700 K / 3 x 430 lm

Energieeffizienzklasse /
energy efficiency class:

A+

Markenleuchtmittel /
branded lamp incl.

↑ 31,5 cm, ↔ 26 cm, ⇄ 21,5 cm

Glas: opal weiß
Glass: opal white
Glas / Glass: 7244, ∅ 8,5 cm, ↑ 8,8 cm



6 Casa / Serie 453
8453.01.32.0000
EAN4003474291505
Messing-matt /
Brass matt finished

 1 x LED / 5 W incl.
2700 K / 1 x 430 lm

Energieeffizienzklasse /
energy efficiency class:

A+

Markenleuchtmittel /
branded lamp incl.

↑ 38 cm, ↔ 24 cm

Glas: opal weiß
Glass: opal white
Glas / Glass: 7244, ∅ 8,5 cm, ↑ 8,8 cm



1 Troja / Serie 973
9973.09.32.0000
EAN4003474291130
Messing-matt / Brass matt finished



9 x LED / 4 W incl.
2700 K / 9 x 370 lm

Energieeffizienzklasse /
energy efficiency class:

A+

Markenleuchtmittel /
branded lamp incl.

Ø 60 cm, H 27 cm

Glas / Glass: 1417,
Ø 12 cm

LED Light
by WOFI



Klassische Harmonie

...classic harmony



4W

370
Lumen

2 Troja / Serie 973
9973.05.32.0000
EAN4003474291123
Messing-matt / Brass matt finished



5 x LED / 4 W incl.
2700 K / 5 x 370 lm

Energieeffizienzklasse /
energy efficiency class:

A+

Markenleuchtmittel /
branded lamp incl.

Ø 51 cm, H 20,5 cm

Glas / Glass: 1417,
Ø 12 cm

New!

New!



3 Troja / Serie 973
9973.09.64.0000
 EAN4003474283678
 Nickel-matt /
 Nickel matt finished



9 x LED / 4 W incl.
 3000 K / 9 x 370 lm

Energieeffizienzklasse /
 energy efficiency class:

A+

Markenleuchtmittel /
 branded lamp incl.

Ø 60 cm, **H** 27 cm

Glas / Glass: 1417,
 Ø 12 cm



Gemacht für Generationen

Klassische Eleganz verbunden mit
 moderner Technologie — die Leuchten
 der Serie TROJA.

Made for generations

Classic elegance combined with
 modern technology — the light of the
 TROJA series.

4 Troja / Serie 973
9973.05.64.0000
 EAN4003474283661
 Nickel-matt / Nickel matt finished



5 x LED / 4 W incl.
 3000 K / 5 x 370 lm

Energieeffizienzklasse /
 energy efficiency class:

A+

Markenleuchtmittel /
 branded lamp incl.

Ø 51 cm, **H** 20,5 cm

Glas / Glass: 1417,
 Ø 12 cm

Lichter wie Flammen

...Lights like flames

1 Sienna / Serie 327
8327.03.01.0000
EAN4003474257396
Chrom / Chrome

 3 x G4 / 12 V / 20 W incl.
2800 K / 3 x 320 lm

Energieeffizienzklasse /
energy efficiency class:

C

Markenleuchtmittel /
branded lamp incl.

Ø 21 cm, ↑ 48 cm



2 Sienna / Serie 327
4327.04.01.0000
EAN4003474263588
Chrom / Chrome

 4 x G4 / 12 V / 20 W incl.
2800 K / 4 x 320 lm

Energieeffizienzklasse /
energy efficiency class:

C

Markenleuchtmittel /
branded lamp incl.

↔ 10 cm, ↑ 33 cm, ↗ 8,5 cm

20W



320
Lumen

3 Sienna / Serie 327
9327.08.01.0750
 EAN4003474262772
 Chrom / Chrome

 8 x G4 / 12 V / 20 W incl.
 2800 K / 8 x 320 lm

Energieeffizienzklasse /
 energy efficiency class:

C

Markenleuchtmittel /
 branded lamp incl.

↔ 75 cm, ↗ 75 cm, ⊥ 16 cm

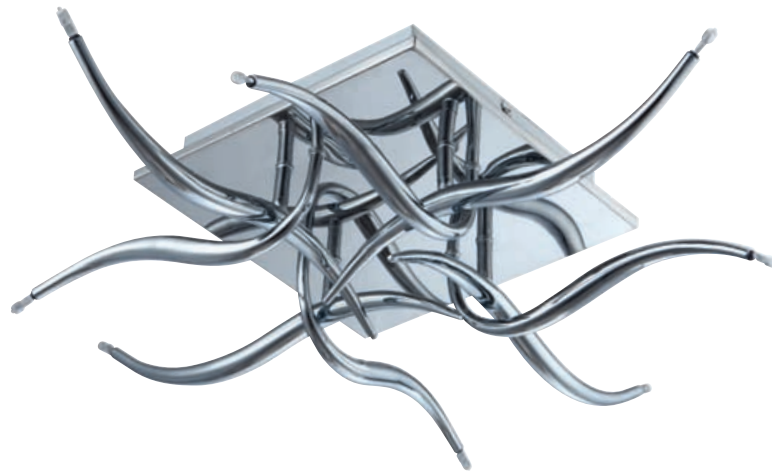

20W

320
 Lumen

4 Sienna / Serie 327
5327.24.01.0000
 EAN4003474257341
 Chrom / Chrome

 24 x G4 / 12 V / 10 W incl.
 2800 K / 24 x 120 lm

Energieeffizienzklasse /
 energy efficiency class:

C

Markenleuchtmittel /
 branded lamp incl.

Ø 100 cm, ⊥ 150 cm
 getrennt schaltbar /
 separately switchable



10W

120
 Lumen

5 Sienna / Serie 327
9327.20.01.0000
 EAN4003474257372
 Chrom / Chrome

 20 x G4 / 12 V / 10 W incl.
 2800 K / 20 x 120 lm

Energieeffizienzklasse /
 energy efficiency class:

C

Markenleuchtmittel /
 branded lamp incl.

Ø 80 cm, ⊥ 28 cm
 getrennt schaltbar /
 separately switchable

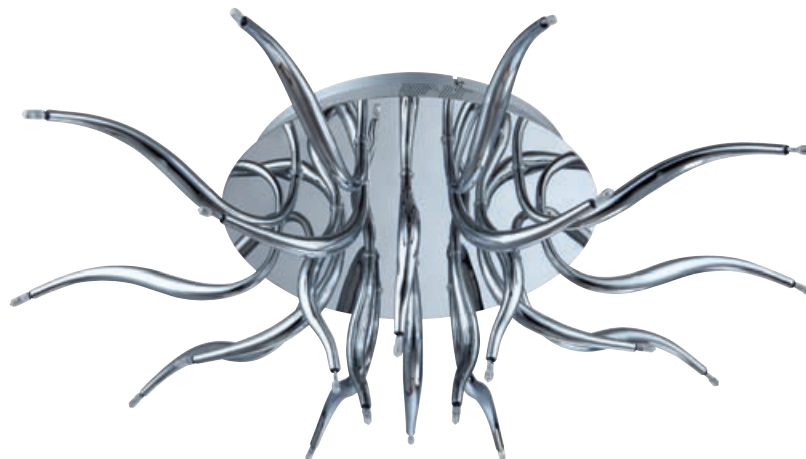

10W

120
 Lumen

1 Harper / Serie 604
9604.06.01.0000
 EAN4003474269207
 Chrom / Chrome

6 x G4 / 12 V / 20 W incl.
 2900 K / 6 x 300 lm

Energieeffizienzklasse /
 energy efficiency class:

C

Markenleuchtmittel /
 branded lamp incl.

↔ 39 cm, ↗ 31 cm,
 ↓ 12 cm

Glasquader: Klar
 Glass cube: clear
 Glas / Glass: 6279

↓ 8 cm, ↔ 2 cm

Design fürs Dasein

Die asymmetrisch angeordneten Glasquader setzen optische Akzente und bestechen durch faszinierende Lichtreflexionen.

20W

300
 Lumen

Design for living with

The asymmetrically laid out glass cuboids create optical accents and captivate with their fascinating light reflections.



Kreuz und Quer beleuchtet

...Nicely lit wherever you look

2 Harper / Serie 604
4604.04.01.0000
 EAN4003474271033
 Chrom / Chrome

4 x G4 / 12 V / 20 W incl.
 2900 K / 4 x 300 lm

Energieeffizienzklasse /
 energy efficiency class:

C

Markenleuchtmittel /
 branded lamp incl.

↓ 41 cm, ↔ 12 cm, ⇄ 7 cm

Glasquader: Klar
 Glass cube: clear
 Glas / Glass: 6279

↓ 8 cm, ↔ 2 cm



3 Harper / Serie 604
9604.10.01.0000
 EAN4003474271767
 Chrom / Chrome

10 x G4 / 12 V / 20 W incl.
 2900 K / 10 x 300 lm

Energieeffizienzklasse /
 energy efficiency class:

C

Markenleuchtmittel /
 branded lamp incl.

↔ 61,5 cm, ↗ 31 cm,
 ↓ 14 cm

Glasquader: Klar
 Glass cube: clear
 Glas / Glass: 6279

*Mit stimmungsvollem
Licht und sanften Schein*
...With soft, atmospheric lighting



I Verre / Serie 240
6240.01.01.0000
EAN4003474271040
Chrom / Chrome

geeignet für / suitable for
Energieeffizienzklasse /
energy efficiency class:

A++  **E**



1 x E27 /
max. 60 W

Fit for LED

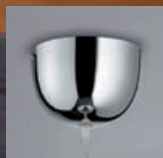

Ø 30 cm, ↓ 150 cm

Glas: klar mit
Drahtgeflecht innen
Glass: clear with
wire inside
Glas / Glass: 6276



1 Verre / Serie 240
9240.07.01.0000
 EAN4003474271101
 Chrom / Chrome

 7 x G4 / 12 V / 20 W incl.
 2900 K / 7 x 300 lm

Energieeffizienzklasse /
 energy efficiency class:



Markenleuchtmittel /
 branded lamp incl.

⊥ 13 cm, ↔ 150 cm, ↗ 55 cm

Glas: klar mit
 Drahtgeflecht innen
 Glass: clear with wire inside
 Glas / Glass: 6275, Ø 8 cm



2 Verre / Serie 240
9240.04.01.0000
 EAN4003474271132
 Chrom / Chrome

 4 x G4 / 12 V / 20 W incl.
 2900 K / 4 x 300 lm

Energieeffizienzklasse /
 energy efficiency class:



Markenleuchtmittel /
 branded lamp incl.

Ø 54 cm, ⊥ 23 cm

Glas: klar mit
 Drahtgeflecht innen
 Glass: clear with wire inside
 Glas / Glass: 6275, Ø 8 cm

20W

300
 Lumen



3 Verre / Serie 240
9240.06.01.0000
 EAN4003474271118
 Chrom / Chrome

 6 x G4 / 12 V / 20 W incl.
 2900 K / 6 x 300 lm

Energieeffizienzklasse /
 energy efficiency class:



Markenleuchtmittel /
 branded lamp incl.

Ø 61 cm, ⊥ 22 cm

Glas: klar mit
 Drahtgeflecht innen
 Glass: clear with wire inside
 Glas / Glass: 6275, Ø 8 cm



4 Verre / Serie 240
9240.08.01.0000
 EAN4003474271125
 Chrom / Chrome

 8 x G4 / 12 V / 20 W incl.
 2900 K / 8 x 300 lm

Energieeffizienzklasse /
 energy efficiency class:



Markenleuchtmittel /
 branded lamp incl.

Ø 76 cm, ⊥ 22 cm

Glas: klar mit
 Drahtgeflecht innen
 Glass: clear with wire inside
 Glas / Glass: 6275, Ø 8 cm



33W
460
Lumen



33W
460
Lumen

5 Verre / Serie 240
8240.01.01.0010
EAN4003474272948
Chrom / Chrome

 1 x G9 / 33 W incl.
2700 K / 1 x 460 lm

Energieeffizienzklasse /
energy efficiency class:

D

Markenleuchtmittel /
branded lamp incl.

HALOGEN
EDV

Ø 13 cm, ↑ 17 cm

Glas: klar mit Drahtgeflecht innen

Glass: clear with wire inside

Glas / Glass: 6091, Ø 2,5 cm
6277, Ø 13 cm



6 Verre / Serie 240
3240.05.01.0000
EAN4003474272931
Chrom / Chrome

 5 x G9 / 33 W incl.
2700 K / 5 x 460 lm

Energieeffizienzklasse /
energy efficiency class:

D

Markenleuchtmittel /
branded lamp incl.

HALOGEN
EDV

Ø 28 cm, ↑ 170 cm

Glas: klar mit
Drahtgeflecht innen

Glass: clear with wire inside

Glas / Glass: 6091, Ø 2,5 cm
6274, Ø 10 cm



7 Verre / Serie 240
8240.01.01.0200
EAN4003474273679
Chrom / Chrome

geeignet für / suitable for
Energieeffizienzklasse /
energy efficiency class:

A++



E
1 x E14 /
max. 40 W

Fit for LED

Ø 20 cm, ↑ 24 cm

Glas: klar mit

Drahtgeflecht innen

Glass: clear with

wire inside

Glas / Glass: 6278, Ø 20 cm



Filigrane Leuchtoobjekte

...Delicate lighting objects

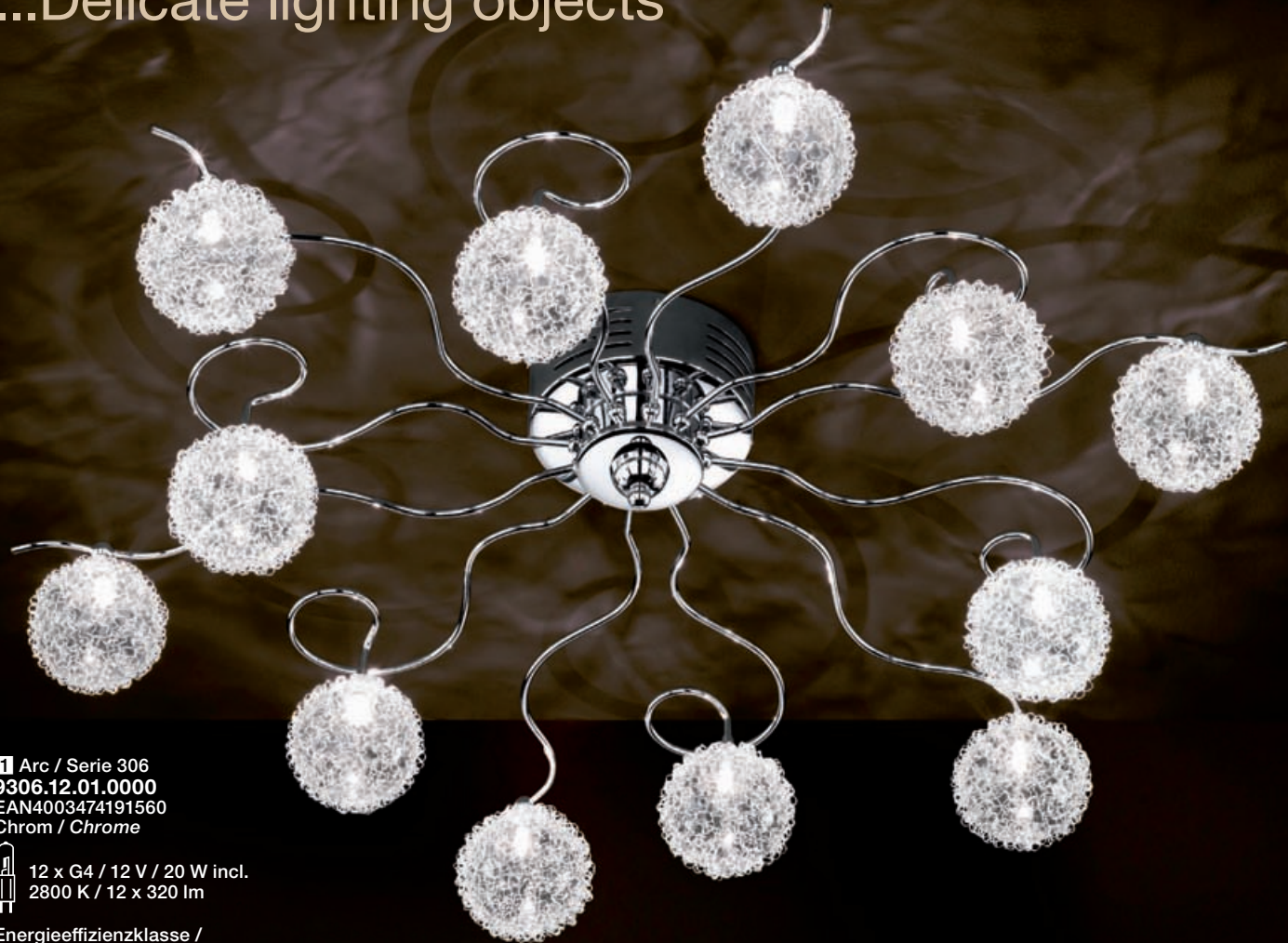

1 Arc / Serie 306
9306.12.01.0000
 EAN4003474191560
 Chrom / Chrome



12 x G4 / 12 V / 20 W incl.
 2800 K / 12 x 320 lm

Energieeffizienzklasse /
 energy efficiency class:

C

Markenleuchtmittel /
 branded lamp incl.

Ø 80 cm, ↓ 22 cm

Glas / Glass:
 6345, Ø 9 cm

20W

320
 Lumen

Gelungene Komposition

ARC – erst die ungewöhnliche Struktur
 macht aus einem Material wie Chrom
 eine so leicht wirkende Kreation.

A successful composition

ARC – it takes an unusual texture to
 turn a material like chrome into an airy
 creation.

2 Arc / Serie 306
8306.01.01.0000
 EAN4003474243108
 Chrom / Chrome



1 x G9 / 33 W incl.
 2700 K / 1 x 460 lm

Energieeffizienzklasse /
 energy efficiency class:

D

Markenleuchtmittel /
 branded lamp incl.



Ø 13 cm, ↓ 18 cm

Glas / Glass:
 6450, Ø 13 cm



33W

460
 Lumen



3 Arc / Serie 306
3306.05.01.0000
 EAN4003474243054
 Chrom / Chrome

5 x G9 / 33 W incl.
 2700 K / 5 x 460 lm

Energieeffizienzklasse /
 energy efficiency class:

D

Markenleuchtmittel /
 branded lamp incl.



Ø 30 cm, ↑ 180 cm

Glas / Glass:
 6452, Ø 11,5 cm

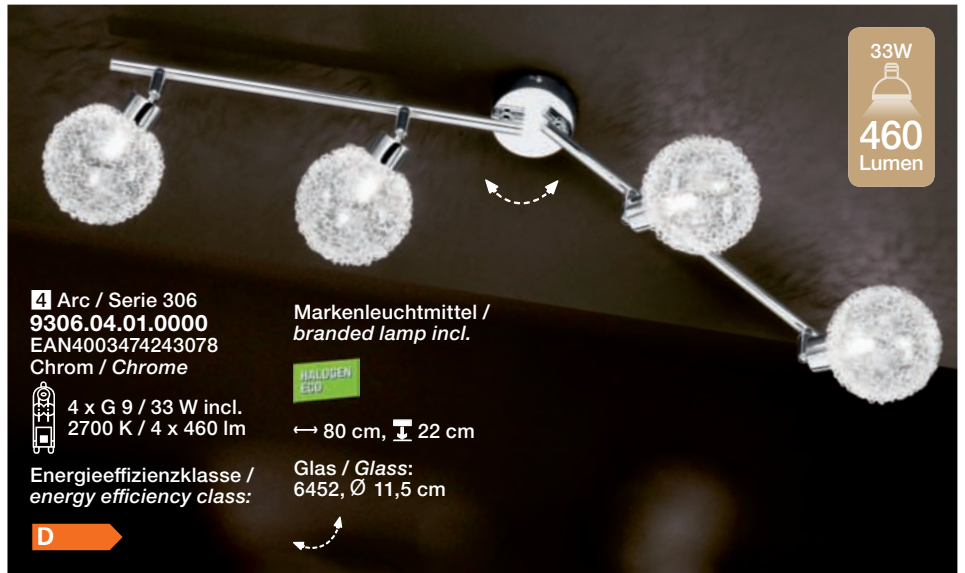

4 Arc / Serie 306
9306.04.01.0000
 EAN4003474243078
 Chrom / Chrome

4 x G 9 / 33 W incl.
 2700 K / 4 x 460 lm

Energieeffizienzklasse /
 energy efficiency class:

D

Markenleuchtmittel /
 branded lamp incl.



↔ 80 cm, ↓ 22 cm

Glas / Glass:
 6452, Ø 11,5 cm



33W

460
 Lumen



5 Arc / Serie 306
9306.03.01.0000
 EAN4003474243061
 Chrom / Chrome

3 x G 9 / 33 W incl.
 2700 K / 3 x 460 lm

Energieeffizienzklasse /
 energy efficiency class:

D

Markenleuchtmittel /
 branded lamp incl.



Ø 50 cm, ↓ 27 cm

Glas / Glass:
 6452, Ø 11,5 cm

↔ 11,5 cm



6 Arc / Serie 306
8306.03.01.0000
 EAN4003474243290
 Chrom / Chrome

3 x G9 / 33 W incl.
 2700 K / 3 x 460 lm

Energieeffizienzklasse /
 energy efficiency class:

D

Markenleuchtmittel /
 branded lamp incl.



↑ 51 cm, Ø 26 cm

Glas / Glass:
 6452, Ø 11,5 cm



Wie Kugelsterne am Nachthimmel

...Star-like spheres in
the midnight sky

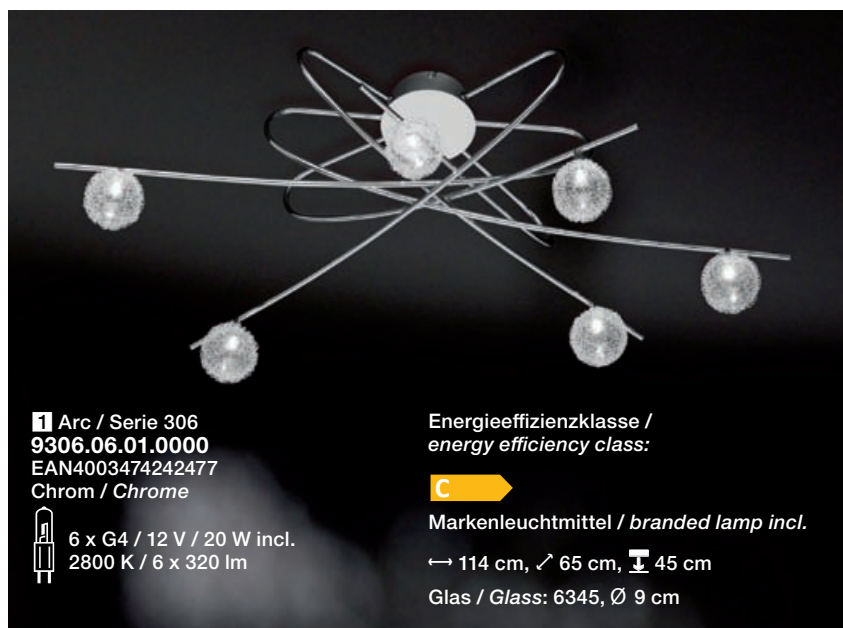

1 Arc / Serie 306
9306.06.01.0000
EAN4003474242477
Chrom / Chrome

 6 x G4 / 12 V / 20 W incl.
2800 K / 6 x 320 lm

Energieeffizienzklasse /
energy efficiency class:



Markenleuchtmittel / *branded lamp incl.*

↔ 114 cm, ↗ 65 cm, ↓ 45 cm

Glas / Glass: 6345, Ø 9 cm



2 Arc / Serie 306
4306.02.01.0000
EAN4003474242507
Chrom / Chrome

 2 x G4 / 12 V / 20 W incl.
2800 K / 2 x 320 lm

Energieeffizienzklasse /
energy efficiency class:



Markenleuchtmittel /
branded lamp incl.

↓ 50 cm, ↔ 15 cm,

↔ 19 cm

Glas / Glass: 6345, Ø 9 cm



3 Arc / Serie 306
7306.08.01.0000
EAN4003474243283
Chrom / Chrome

 8 x G4 / 12 V / 20 W incl.
2800 K / 8 x 320 lm

Energieeffizienzklasse /
energy efficiency class:



Markenleuchtmittel /
branded lamp incl.

Ø 40 cm, ↓ 150 cm

Glas / Glass: 6374, Ø 13 cm



1 Astro / Serie 360
9360.16.01.0000
 EAN4003474231440
 Chrom / Chrome



16 x G4 / 12 V / 20 W incl.
 2900 K / 16 x 300 lm

Energieeffizienzklasse /
 energy efficiency class:



Markenleuchtmittel /
 branded lamp incl.

Ø 106 cm, \downarrow 36 cm
 Glas / Glass: 6345, Ø 9 cm

20W



300
 Lumen

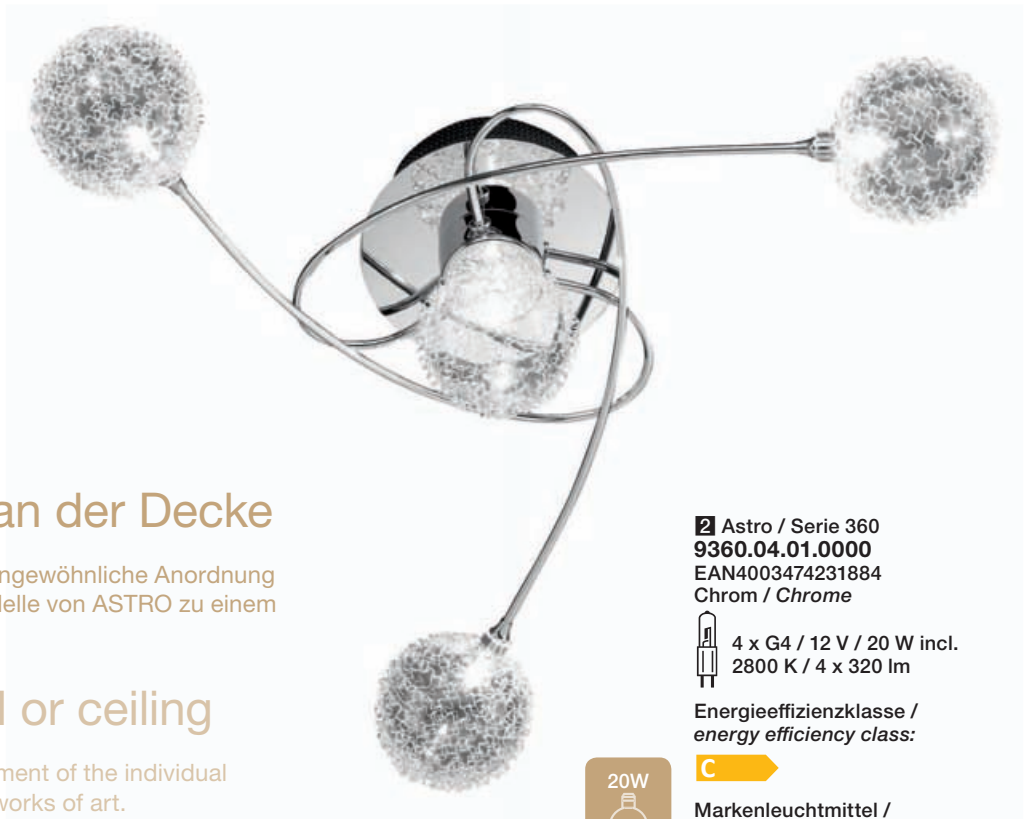
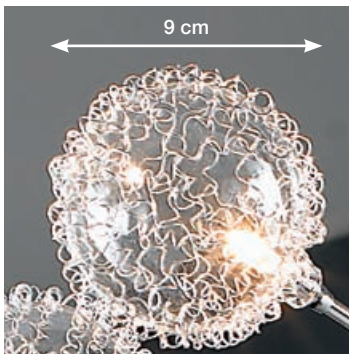

An der Wand oder an der Decke

Die Leichtigkeit der Struktur und die ungewöhnliche Anordnung der einzelnen Kugeln machen die Modelle von ASTRO zu einem Gesamtkunstwerk.

Mounted to the wall or ceiling

Airy textures and the unusual arrangement of the individual spheres turn the ASTRO models into works of art.

2 Astro / Serie 360
9360.04.01.0000
 EAN4003474231884
 Chrom / Chrome



4 x G4 / 12 V / 20 W incl.
 2800 K / 4 x 320 lm

Energieeffizienzklasse /
 energy efficiency class:



Markenleuchtmittel /
 branded lamp incl.

Ø 52 cm, \downarrow 20 cm
 Glas / Glass: 6345, Ø 9 cm

20W



320
 Lumen

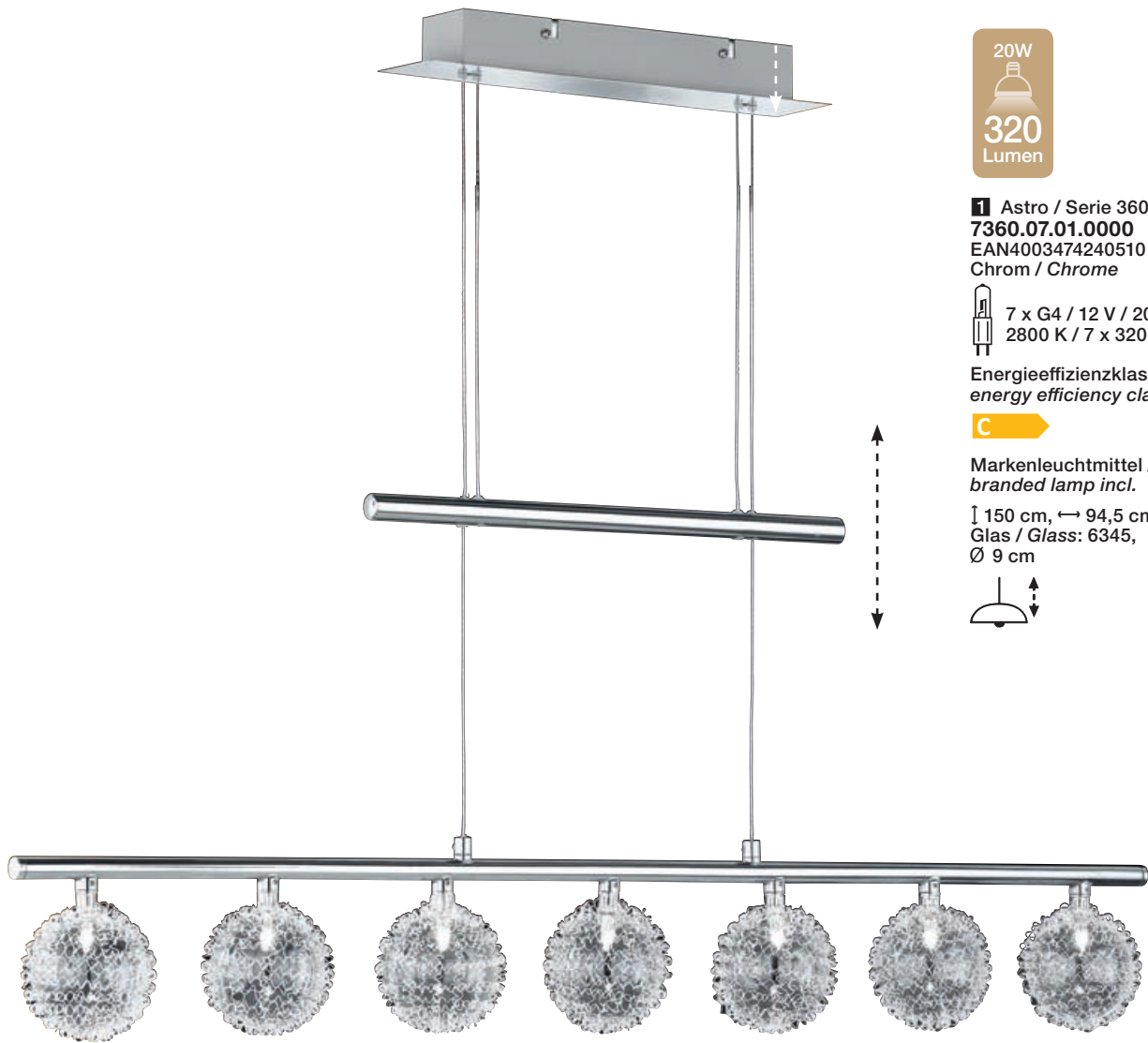

20W
320
Lumen

1 Astro / Serie 360
7360.07.01.0000
EAN4003474240510
Chrom / Chrome

 7 x G4 / 12 V / 20 W incl.
2800 K / 7 x 320 lm

Energieeffizienzklasse /
energy efficiency class:

C

Markenleuchtmittel /
branded lamp incl.

↑ 150 cm, ↔ 94,5 cm
Glas / Glass: 6345,
Ø 9 cm



10W
120
Lumen

2 Astro / Serie 360
4360.06.01.0000
EAN4003474231969
Chrom / Chrome

 6 x G4 / 12 V / 10 W incl.
2800 K / 6 x 120 lm

Energieeffizienzklasse /
energy efficiency class:

C

Markenleuchtmittel /
branded lamp incl.

↑ 150 cm, ↔ 73,5 cm
Glas / Glass: 6345,
Ø 9 cm

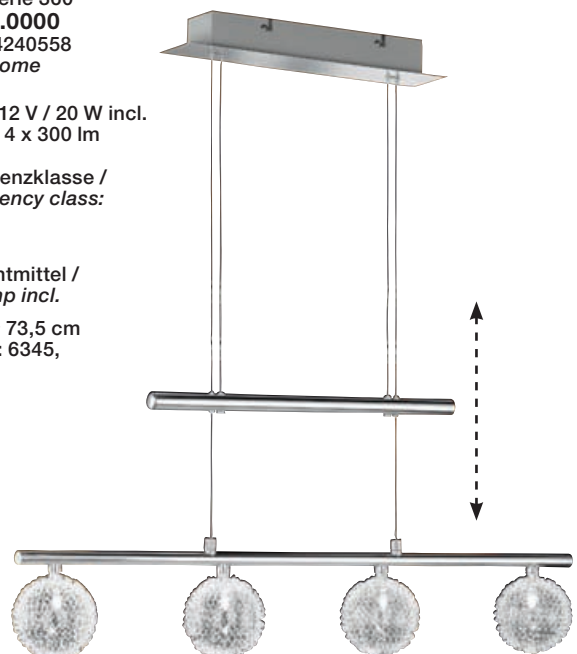

20W
300
Lumen

3 Astro / Serie 360
7360.04.01.0000
EAN4003474240558
Chrom / Chrome

 4 x G4 / 12 V / 20 W incl.
2900 K / 4 x 300 lm

Energieeffizienzklasse /
energy efficiency class:

C

Markenleuchtmittel /
branded lamp incl.

↑ 150 cm, ↔ 73,5 cm
Glas / Glass: 6345,
Ø 9 cm



20W

300
 Lumen

4 Astro / Serie 360
9360.09.01.0000
 EAN4003474231419
 Chrom / Chrome

 9 x G4 / 12 V / 20 W incl.
 2900 K / 9 x 300 lm

Energieeffizienzklasse /
 energy efficiency class:

C

Markenleuchtmittel /
 branded lamp incl.

Ø 94 cm,  25 cm

Glas / Glass: 6345, Ø 9 cm

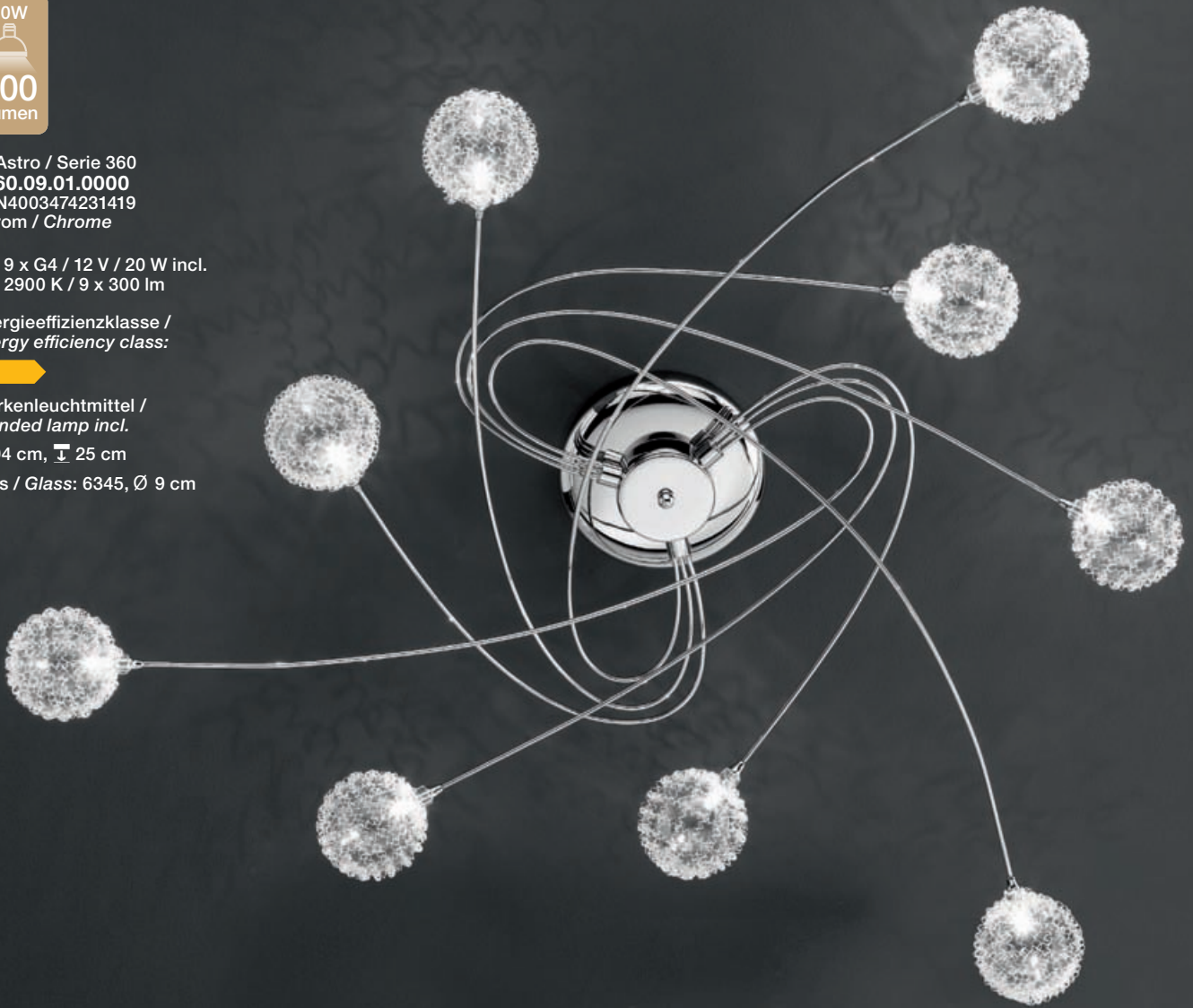

5 Astro / Serie 360
9360.06.01.0000
 EAN4003474231433
 Chrom / Chrome

 6 x G4 / 12 V / 20 W incl.
 2900 K / 6 x 300 lm

Energieeffizienzklasse /
 energy efficiency class:

C

Markenleuchtmittel /
 branded lamp incl.

Ø 86 cm,  20 cm

Glas / Glass: 6345, Ø 9 cm







Ø 34 cm

1 Deventer / Serie 449
6449.01.01.0350
EAN4003474261928
Chrom / Chrome

geeignet für / suitable for
Energieeffizienzklasse /
energy efficiency class:



  1 x E27 /
max. 60 W

Fit for LED

Ø 34 cm, ↓ 150 cm



2 Deventer / Serie 449
3449.01.01.0000
 EAN4003474259703
 Chrom / Chrome

geeignet für / suitable for
 Energieeffizienzklasse /
 energy efficiency class:



Fit for LED

Ø 32 cm, ↑ 170 cm, ⇄ 90 cm



3 Deventer / Serie 449
8449.01.01.0000
 EAN4003474259277
 Chrom / Chrome

geeignet für / suitable for
 Energieeffizienzklasse /
 energy efficiency class:

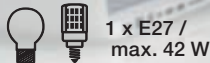

Fit for LED

Ø 14 cm, ↑ 70 cm, ⇄ 50 cm



4 Deventer / Serie 449
6449.01.01.0250
 EAN4003474261935
 Chrom / Chrome

geeignet für / suitable for
 Energieeffizienzklasse /
 energy efficiency class:



Fit for LED

Ø 23 cm, ↑ 150 cm

**Bringt Loft-Feeling
 ins Haus**
 ...Adds loft flair to your home

Alltagstauglich

Design im Industrie-Look und moderne Technologie
 meistern auch die strengsten Arbeitsbedingungen im
 alltäglichen Leben perfekt.

Fit for every day use

Industrial design looks and modern technology master
 even the hardest working conditions without fail.





1 Zoon / Serie 192
6192.01.01.0000
 EAN4003474269436
 Chrom / Chrome

geeignet für / suitable for
 Energieeffizienzklasse /
 energy efficiency class:

A++  **E**

  1 x E27 /
 max. 60 W

Fit for LED

Ø 30 cm, ↓ 150 cm

Glas weiß mit Spiraldekor /
 Glass white with spiral
 decoration
 Glas / Glass: 6173



2 Flame / Serie 141
6141.01.64.0000
 EAN4003474169200
 Nickel-matt /
 Nickel matt finished

geeignet für / suitable for
 Energieeffizienzklasse /
 energy efficiency class:

A++  **E**

  1 x E 27 /
 max. 60 W

Fit for LED

Ø 12 cm, ↓ 150 cm

Glas: opal weiß /
 Glass: opal white
 Glas / Glass: 7054,
 ↔ 11 cm, ↓ 20,5 cm



3 Modena / Serie 273
6273.01.70.1200
 EAN4003474245324
 Silber / Silver

geeignet für / suitable for
 Energieeffizienzklasse /
 energy efficiency class:

A++  **E**

  1 x E27 /
 max. 60 W

Fit for LED

Ø 20 cm, ↓ 150 cm



4 Clara / Serie 804
6804.01.64.0000
 EAN4003474152752
 Nickel-matt / Nickel matt finished

geeignet für / suitable for
 Energieeffizienzklasse /
 energy efficiency class:

A++  **E**

  1 x E27 /
 max. 60 W

Fit for LED

Ø 20 cm, ↓ 150 cm

Glas / Glass: 7376, ↔ 20 cm

33W
460
Lumen



1 Chateau / Serie 494
8494.01.01.0010
EAN4003474259536
Chrom / Chrome

 1 x G9 / 33 W incl.
2700 K / 1 x 460 lm

Energieeffizienzklasse /
energy efficiency class:

D

Markenleuchtmittel /
branded lamp incl.

HALOGEN
E27

Ø 16 cm, ↑ 37 cm

Glas: weiß glänzend /
Glass: white shiny
Glas / Glass: 6070



2 Chateau / Serie 494
6494.01.01.0000
EAN4003474259550
Chrom / Chrome

geeignet für / suitable for
Energieeffizienzklasse /
energy efficiency class:

A++  **E**

  1 x E27 /
max. 60 W

Fit for LED

Ø 26 cm, ↑ 150 cm

Glas: weiß glänzend /
Glass: white shiny
Glas / Glass: 6078, Ø 26 cm

*Eine perfekte
Silhouette*
...A perfect silhouette

Für Nostalgie-Fans

...For fans of nostalgia



1 Lacchino / Serie 128
5128.03.09.0000
 EAN4003474168654
 Antik braun / Antique brown

geeignet für / suitable for
 Energieeffizienzklasse /
 energy efficiency class:



Fit for LED
 Ø 80 cm, ↓ 150 cm
 Glas / Glass: 7083,
 ↔ 24,5 cm, ↓ 10,7 cm



2 Lacchino / Serie 128
6128.01.09.0000
 EAN4003474168661
 Antik braun / Antique brown

geeignet für / suitable for
 Energieeffizienzklasse /
 energy efficiency class:



Fit for LED
 Ø 30 cm, ↓ 150 cm
 Glas / Glass: 6284,
 ↔ 30 cm, ↓ 14,5 cm



3 Lacchino / Serie 128
7128.02.09.0000
 EAN4003474168432
 Antik braun / Antique brown

geeignet für / suitable for
 Energieeffizienzklasse /
 energy efficiency class:



Fit for LED
 ↓ 150 cm, ↔ 78 cm
 Glas / Glass: 7083,
 ↔ 24,5 cm, ↓ 10,7 cm



4 Lacchino / Serie 128
4128.01.09.0000
 EAN4003474168647
 Antik braun / Antique brown

geeignet für / suitable for
 Energieeffizienzklasse /
 energy efficiency class:



Fit for LED
 ↔ 52 cm, ↗ 15 cm, ↓ 21 cm
 Glas / Glass: 7085, ↔ 30 cm

Licht wie aus einer Marmor-Schale

Die wunderschönen Maserungen im Glas geben dem Licht aus der Serie LACCHINO seine warme, goldene Tönung. Als perfekte Ergänzung zu einem puristischen Wohnstil.

Light that seems to come from a marble bowl

The LACCHINO series gives light a warm, golden hue with its gorgeous marbled glass. An ideal addition to a classic decorating style.

6284

7082

5 Lacchino / Serie 128
3128.02.09.0000
 EAN4003474169484
 Antik braun / *Antique brown*

geeignet für / *suitable for*
 Energieeffizienzklasse /
energy efficiency class:

A++  **E**



1 x E27 / max. 150 W



1 x E14 / max. 40 W

∩ 180 cm, ⇨ 25 cm

Glas / *Glass*: 6284, ⇔ 30 cm
 7082 ⇔ 15 cm



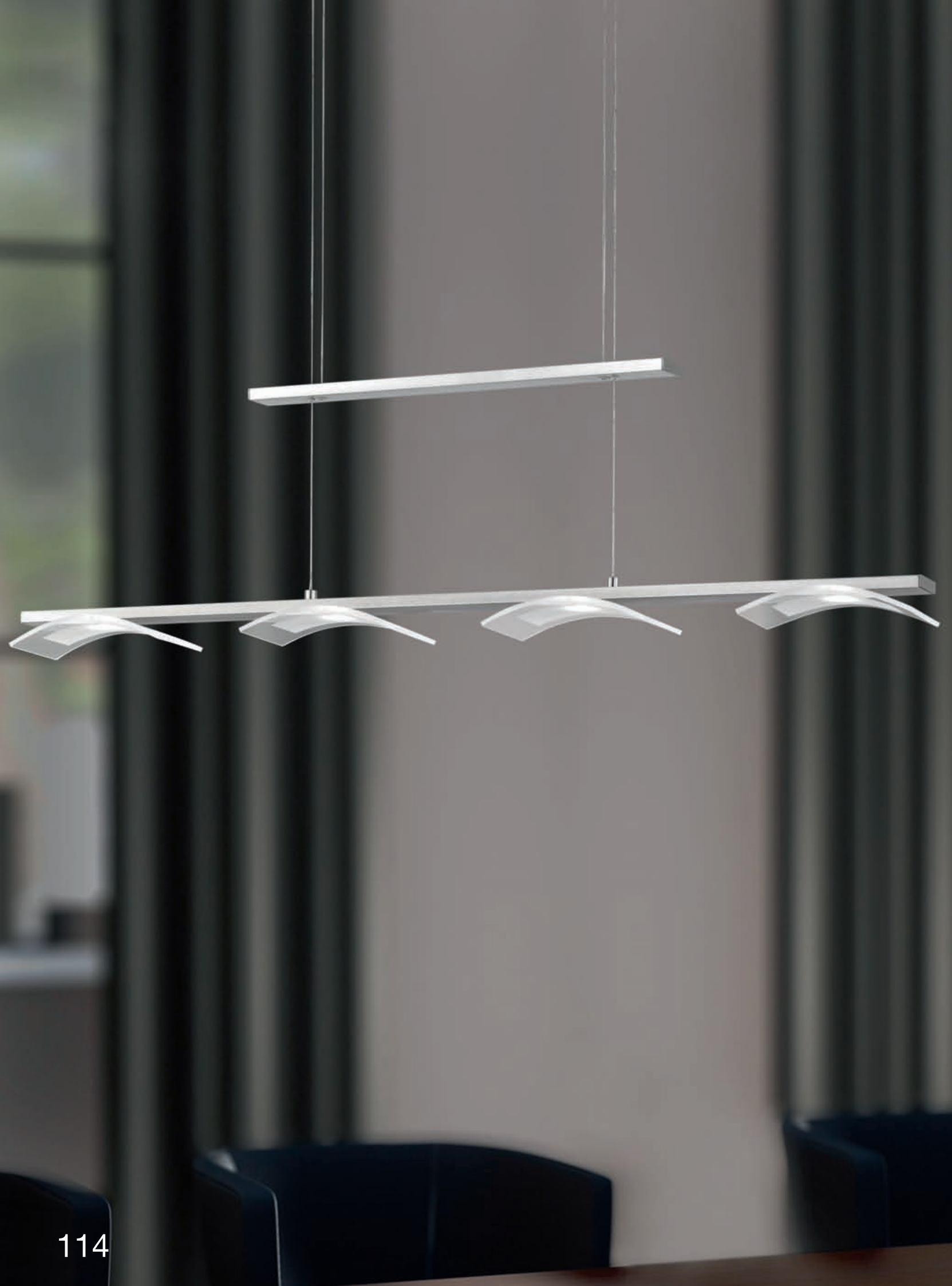

Höhenverstellbare Pendelleuchten

...Height adjustable pendants

Aktuelles für den Wohlfühlbereich

Die richtige Beleuchtung ist ein wichtiges Mittel bei der Raumgestaltung. Unsere Pendelleuchten sind über Arbeitsflächen oder Esstischen nicht nur äußerst nützlich, sie strahlen immer auch eine gewisse Wärme aus, die Behaglichkeit schafft.

The latest for your comfort zone

Perfect light is an important tool for great interior design. Our pendants aren't just useful above work areas and dining room tables – they also radiate a sense of comfort and warmth.

Lenox	116
Evry	117
Roma	118
Contes	119
Interio	120
Vileta	121
Cara	122
Gess	123
Atlanta	124
Talas	125
Ava	126
Parker	127
Oklahoma	128
Columbia	129
Nashville	129
Madison	130
Teen	130
Dia	131
Savannah	132
Sacramento	134
Augusta	136
Santa Fee	137
Avanti	137
Mali	138
Point	139

weitere höhenverstellbare Pendelleuchten
/ additional high adjustable pendants | 140

5W
400
Lumen



9 cm

LED Light
by WOFI

Lenox / Serie 378
7378.04.64.0000
EAN4003474273990
Nickel-matt /
Nickel matt finished

 4 x LED / 5 W incl.
3000 K / 4 x 400 lm

Energieeffizienzklasse /
energy efficiency class:

A+

Markenleuchtmittel /
branded lamp incl.

∩ 150 cm, ↔ 80 cm

Glas: mattiert mit Klarrand /
Glass: frosted with clear border
Glas / Glass: 6272

Dimmbar mittels geeignetem
Wanddimmer / dimmable by
suitable wall dimmer



5W
400
Lumen

New!
New!

Schlichte klassische Eleganz

...Simple but classic elegance



Leuchten für Generationen

Zukunftsweisende Technologie verknüpft mit schlichter und klassischer Eleganz.

Lighting for generations

Cutting edge technology combined with simple and classic elegance.

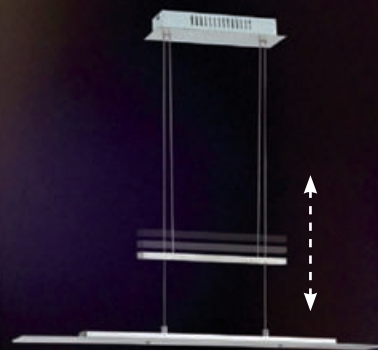

LED Light by WOFF

1 Evry / Serie 420
7420.04.64.0000
EAN4003474281865
Nickel-matt /
Nickel matt finished

 4 x LED / 5 W incl.
3000 K / 4 x 400 lm

Energieeffizienzklasse /
energy efficiency class:

A+

Markenleuchtmittel /
branded lamp incl.

↑ 150 cm, ↔ 80 cm, ↗ 8 cm
Glas / Glass: 1407



LED Light
by **WOFI**

21,6W

1800
Lumen

New!
New!

Innovativer Klassiker

...innovative classics



R Roma / Serie 120
6120.01.54.0000
EAN4003474291048
Nickel-matt / Chrom /
Nickel matt finished / Chrome



1 x LED / 21,6 W incl.
3000 K / 1 x 1800 lm

Energieeffizienzklasse /
energy efficiency class:

A

Markenleuchtmittel /
branded lamp incl.

Ø 35 cm, ↑ 150 cm

Glas / Glass: 6377

Dimmbar mittels geeignetem
Wanddimmer / dimmable by
suitable wall dimmer



New!
New!

LED Light
by **WOFI**

1 Contes / Serie 970
7970.04.64.0000
EAN4003474290645
Nickel-matt /
Nickel-matt finished

 4 x LED / 4,5 W incl.
3000 K / 4 x 400 lm

Energieeffizienzklasse /
energy efficiency class:

A+

Markenleuchtmittel /
branded lamp incl.

↑ 150 cm, ↔ 100 cm, ↗ 10 cm

Glas: Acryl
Glass: Acrylic

Glas / Glass: 7243,
↑ 18 cm, ↔ 10 cm

Dimmbar mittels geeignetem
Wanddimmer / dimmable by
suitable wall dimmer



Vollendung in
Form, Proportion
und Material

Perfection in
form, proportion
and material



4,5W

400
Lumen

2 Contes / Serie 970
7970.04.22.0000
EAN4003474290997
Messing modern /
Brass modern

 4 x LED / 4,5 W incl.
2700 K / 4 x 400 lm

Energieeffizienzklasse /
energy efficiency class:

A+

Markenleuchtmittel /
branded lamp incl.

↑ 150 cm, ↔ 100 cm, ↗ 10 cm

Glas: Acryl
Glass: Acrylic

Glas / Glass: 7243,
↑ 18 cm, ↔ 10 cm

Dimmbar mittels geeignetem
Wanddimmer / dimmable by
suitable wall dimmer



1 Interio / Serie 619
7619.04.01.0000
 EAN4003474249094
 Chrom / Chrome



4 x LED / 6,5 W incl.
 3500 K / 4 x 420 lm

Energieeffizienzklasse /
 energy efficiency class:

A

Markenleuchtmittel /
 branded lamp incl.

↑ 150 cm, ↔ 76 cm

Ultra Weißglas /
 Ultra white glass
 Glas / Glass: 6038

↔ 16 cm, ↓ 9 cm



6,5W



420
 Lumen



LED Light
 by **WOLFF**



4,8W



410
 Lumen

2 Interio / Serie 619
7619.06.01.1000
 EAN4003474262475
 Chrom / Chrome



6 x LED / 4,8 W incl.
 3000 K / 6 x 410 lm

Energieeffizienzklasse /
 energy efficiency class:

A+

Markenleuchtmittel /
 branded lamp incl.

↑ 150 cm, ↔ 113 cm

Ultra Weißglas /
 Ultra white glass
 Glas / Glass: 6038

↔ 16 cm, ↓ 9 cm

Dimmbar mittels ge-
 eignetem Wanddimmer /
 dimmable by suitable
 wall dimmer



Aufs wesentliche Design reduziert

...Reduced to the max

Neu!
New!



4,5W
360
Lumen

Vileta / Serie 254
7254.03.64.1000
EAN4003474281940
Nickel-matt /
Nickel matt finished

 3 x LED / 4,5 W incl.
3000 K / 3 x 360 lm

Energieeffizienzklasse /
energy efficiency class:

A+

Markenleuchtmittel /
branded lamp incl.

↑ 120 cm, ↔ 56 cm

Glas / Glass: 3037
↔ 12 cm, ↓ 9 cm



Vileta / Serie 254
7254.05.64.0000
EAN4003474281957
Nickel-matt /
Nickel matt finished

 5 x LED / 4,5 W incl.
3000 K / 5 x 360 lm

Energieeffizienzklasse /
energy efficiency class:

A+

Markenleuchtmittel /
branded lamp incl.

↑ 120 cm, ↔ 100 cm

Glas / Glass: 3037
↔ 12 cm, ↓ 9 cm

Dimmbar mittels geeignetem Wand-
dimmer / dimmable by
suitable wall dimmer



5W
450
Lumen

1 Cara / Serie 535
7535.05.32.0000
EAN4003474273600
Messing-matt /
Brass matt finished



5 x LED / 5 W incl.
3000 K / 5 x 450 lm

Energieeffizienzklasse /
energy efficiency class:

A⁺

Markenleuchtmittel /
branded lamp incl.

↑ 150 cm, ↔ 69 cm

Glas: opal weiß satiniert /
Innenschliff
Glass: opal white satined /
cutline inside

Glas / Glass: 6267,
Ø 9 cm, ↓ 6,55 cm

Dimmbar mittels ge-
eignetem Wanddimmer /
dimmable by suitable
wall dimmer



LED Light
by **WOFI**

2 Cara / Serie 535
7535.05.64.0000
EAN4003474270722
Nickel-matt /
Nickel matt finished



5 x LED / 5 W incl.
3000 K / 5 x 450 lm

Energieeffizienzklasse /
energy efficiency class:

A⁺

Markenleuchtmittel /
branded lamp incl.

↑ 150 cm, ↔ 69 cm

Glas: opal weiß satiniert /
Innenschliff
Glass: opal white satined /
cutline inside

Glas / Glass: 6267,
Ø 9 cm, ↓ 6,55 cm

Dimmbar mittels ge-
eignetem Wanddimmer /
dimmable by suitable
wall dimmer





4W

360
Lumen



1 Gess / Serie 435
7435.05.54.0000
EAN4003474274164
Nickel-matt / Chrom
Nickel matt finished / Chrome

 5 x LED / 4 W incl.
3000 K / 5 x 360 lm

Energieeffizienzklasse /
energy efficiency class:

A+

Markenleuchtmittel /
branded lamp incl.

↔ 93 cm, ↑ 150 cm

Glas: weiß satiniert cutline innen
Glass: opal white
Glas / Glass: 6261, Ø 11 cm, ↑ 7 cm

Dimmbar mittels geeignetem
Wanddimmer / dimmable by
suitable wall dimmer



2 Gess / Serie 435
7435.08.54.0000
EAN4003474274171
Nickel-matt / Chrom
Nickel matt finished / Chrome

 8 x LED / 4 W incl.
3000 K / 8 x 360 lm

Energieeffizienzklasse /
energy efficiency class:

A+

Markenleuchtmittel /
branded lamp incl.

↔ 154,5 cm, ↑ 150 cm

Glas: weiß satiniert cutline innen
Glass: opal white
Glas / Glass: 6261, Ø 11 cm, ↑ 7 cm

Dimmbar mittels geeignetem
Wanddimmer / dimmable by
suitable wall dimmer



LED Light
by WOFI



1 Atlanta / Serie 886
7886.05.64.0000
EAN4003474237251
Nickel-matt / Nickel matt finished



5 x LED / 5 W incl.
3000 K / 5 x 420 lm

Energieeffizienzklasse /
energy efficiency class:

A⁺

Markenleuchtmittel /
branded lamp incl.

↓ 150 cm, ↔ 85 cm, ↗ 41 cm

Glas: weiß lackiert mit Klarrand /
Glass: white lacquered with clear border
Glas / Glass: 6097, ↔ 7,4 cm

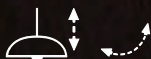

7,4 cm

5W

420
Lumen

1 Talas / Serie 596
7596.06.64.0000
EAN4003474235509
Nickel-matt / Nickel matt finished



6 x LED / 5 W incl.
3000 K / 6 x 420 lm

Energieeffizienzklasse /
energy efficiency class:

A+

Markenleuchtmittel /
branded lamp incl.

⌈ 150 cm, ⇄ 115 cm, ↗ 37 cm

Glas: opal weiß / Glass: opal white
Glas / Glass: 6312, ⇄ 7 cm

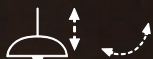

5W

420
Lumen



Schwenkbarer Doppeldecker

...Pivoting double-deck

Flexibilität durch
Höhenverstellbarkeit

Flexibility through
adjustable height

2 Talas / Serie 596
7596.04.64.0000
EAN4003474235639
Nickel-matt / Nickel matt finished



4 x LED / 5 W incl.
3000 K / 4 x 420 lm

Energieeffizienzklasse /
energy efficiency class:

A+

Markenleuchtmittel /
branded lamp incl.

⌈ 150 cm, ⇄ 75 cm, ↗ 37 cm

Glas: opal weiß / Glass: opal white
Glas / Glass: 6312, ⇄ 7 cm



5W

420
Lumen



1 Ava / Serie 270
7270.06.64.0000
 EAN4003474272733
 Nickel-matt / Nickel matt finished



6 x LED / 4,8 W incl.
 3000 K / 6 x 410 lm

Energieeffizienzklasse /
 energy efficiency class:

A+

Markenleuchtmittel /
 branded lamp incl.

↓ 150 cm, ↔ 113,5 cm

Glas: opal weiß / Glass: opal white
 Glas / Glass: 6232, ↔ 13,5 cm

Dimmbar mittels ge-
 eignetem Wanddimmer /
 dimmable by suitable
 wall dimmer

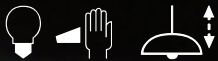

4,8W

410
 Lumen



LED Light
 by **WOFI**

2 Ava / Serie 270
7270.04.64.0000
 EAN4003474268804
 Nickel-matt / Nickel matt finished



4 x LED / 4,8 W incl.
 3000 K / 4 x 410 lm

Energieeffizienzklasse /
 energy efficiency class:

A+

Markenleuchtmittel /
 branded lamp incl.

↓ 150 cm, ↔ 80 cm

Glas: opal weiß / Glass: opal white
 Glas / Glass: 6232, ↔ 13,5 cm

Dimmbar mittels ge-
 eignetem Wanddimmer /
 dimmable by suitable
 wall dimmer





P Parker / Serie 988
 7988.04.01.0100
 EAN4003474251660
 Chrom / Chrome



4 x GY6,35 / 12 V / 35 W incl.
 2900 K / 4 x 580 lm

Energieeffizienzklasse /
 energy efficiency class:



Markenleuchtmittel /
 branded lamp incl.

∩ 150 cm, ↔ 72 cm

Glas: weiß gewischt /
 Glass: white wipe technique
 Glas / Glass: 7811,
 Ø 9 cm, ∩ 7,5 cm



I Oklahoma / Serie 923
7923.04.64.0000
EAN4003474207261
Nickel-matt /
Nickel matt finished

 4 x G9 / 33 W incl.
 2700 K / 4 x 460 lm

Energieeffizienzklasse /
energy efficiency class:

D

Markenleuchtmittel /
branded lamp incl.

 HALOGEN
EDV

↑ 150 cm, ↔ 66 cm

Glas: weiß lackiert /
Glass: white lacquered
Glas / Glass: 7338, ↔ 9 cm



↔ 9 cm

33W

460
Lumen

1 Columbia / Serie 894
7894.04.64.0106
 EAN4003474212791
 Nickel-matt /
 Nickel matt finished

 4 x E14 / 7 W incl.
 2700 K / 4 x 280 lm

Energieeffizienzklasse /
 energy efficiency class:

B

 warm white

∫ 150 cm, ↔ 66 cm

Glas: weiß lackiert /
 Glass: white lacquered
 Glas / Glass: 7004, ↔ 9 cm



7W

280
 Lumen

2 Nashville / Serie 895
7895.04.64.0106
 EAN4003474212623
 Nickel-matt /
 Nickel matt finished

 4 x E14 / 7 W incl.
 2700 K / 4 x 280 lm

Energieeffizienzklasse /
 energy efficiency class:

B

 warm white

∫ 150 cm, ↔ 84 cm, ↗ 34 cm

Glas: weiß lackiert /
 Glass: white lacquered
 Glas / Glass: 7004, ↔ 9 cm



1 Madison / Serie 942
7942.04.64.0100
 EAN4003474183510
 Nickel-matt / *Nickel matt finished*

 4 x GY6,35 / 12 V / 35 W incl.
 2900 K / 4 x 580 lm

Energieeffizienzklasse /
energy efficiency class:

C

Markenleuchtmittel /
branded lamp incl.

↓ 150 cm, ↔ 73 cm

Glas: weiß satiniert /
Glass: white satin
 Glas / Glass: 7633, ↔ 9 cm



↔ 9 cm

35W

580
 Lumen

2 Teen / Serie 488
7488.05.64.0100
 EAN4003474170930
 Nickel-matt / *Nickel matt finished*

 5 x G4 / 12 V / 20 W incl.
 2800 K / 5 x 320 lm

Energieeffizienzklasse /
energy efficiency class:

C

Markenleuchtmittel /
branded lamp incl.

↓ 150 cm, ↔ 90 cm, ↗ 41 cm

Glas opal weiß / *Glass opal white*
 Glas / Glass: 7300, ↔ 7 cm



20W

320
 Lumen

20W

320
Lumen

1 Dia / Serie 897
7897.06.64.0100
 EAN4003474162294
 Nickel-matt / *Nickel matt finished*

 6 x G4 / 12 V / 20 W incl.
 2800 K / 6 x 320 lm

Energieeffizienzklasse /
 energy efficiency class:

C

Markenleuchtmittel /
 branded lamp incl.

↓ 150 cm, ↔ 115 cm, ↗ 37 cm

Glas: opal weiß /
 Glass: *opal white*
 Glas / Glass: 7300, ↔ 7 cm



2 Dia / Serie 897
7897.04.64.0100
 EAN4003474162287
 Nickel-matt /
Nickel matt finished

 4 x GY 6,35 / 12 V / 35 W incl.
 2900 K / 4 x 580 lm

Energieeffizienzklasse /
 energy efficiency class:

C

Markenleuchtmittel /
 branded lamp incl.

↓ 150 cm, ↔ 75 cm, ↗ 37 cm

Glas: opal weiß /
 Glass: *opal white*
 Glas / Glass: 7300, ↔ 7 cm



Elegante Raumwunder ...Elegant space savers



35W

580
Lumen

Mattes Glas trifft Metall

Erst der Material-Mix aus weiß-gewischem Glas mit Nickel macht die SAVANNAH-Leuchten zu einem schönen Blickfang.

Matt glass meets metal

The contrasting materials – matt white glass and nickel – turn SAVANNAH lamps into beautiful eye-catchers.



1 Savannah / Serie 722
7722.03.64.0006
EAN4003474209234
Nickel-matt /
Nickel matt finished

 3 x E14 / 11 W incl.
2500 K / 3 x 660 lm

Energieeffizienzklasse /
energy efficiency class:

A

Markenleuchtmittel /
branded lamp incl.

 warm white
↓ 150 cm, ↔ 100 cm

Glas: weiß gewischt /
Glass: white wipe technique
Glas / Glass: 7724, ↔ 18 cm



11W

660
Lumen

Der Materialmix macht's

...It's all in the mix



2 Savannah / Serie 722
7722.02.64.0006
 EAN4003474209203
 Nickel-matt /
 Nickel matt finished

2 x E14 / 11 W incl.
 2500 K / 2 x 660 lm

Energieeffizienzklasse /
 energy efficiency class:



Markenleuchtmittel /
 branded lamp incl.

ESL warm white
 ↓ 150 cm, ↔ 60 cm

Glas: weiß gewischt /
 Glass: white wipe technique
 Glas / Glass: 7724, ↔ 18 cm

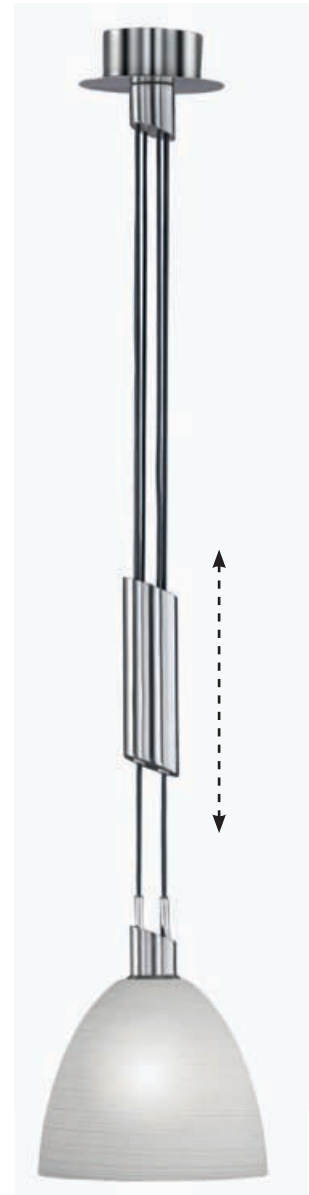

3 Savannah / Serie 722
6722.01.64.0006
 EAN4003474209173
 Nickel-matt /
 Nickel matt finished

1 x E14 / 11 W incl.
 2500 K / 1 x 660 lm

Energieeffizienzklasse /
 energy efficiency class:



Markenleuchtmittel /
 branded lamp incl.

ESL warm white
 Ø 18 cm, ↓ 150 cm

Glas: weiß gewischt /
 Glass: white wipe technique
 Glas / Glass: 7724, ↔ 18 cm





S Sacramento / Serie 744
7744.03.64.0000
EAN4003474195698
Nickel-matt / *Nickel matt finished*

 3 x G9 / 48 W incl.
2800 K / 3 x 740 lm

Energieeffizienzklasse /
energy efficiency class:

D

Markenleuchtmittel /
branded lamp incl.

 HALOGEN
E27

↓ 150 cm, ↔ 100 cm

Glas: weiß satiniert /
Glass: white satin
Glas / Glass: 7642, ↔ 25 cm



↔ 25 cm

48W

740
Lumen

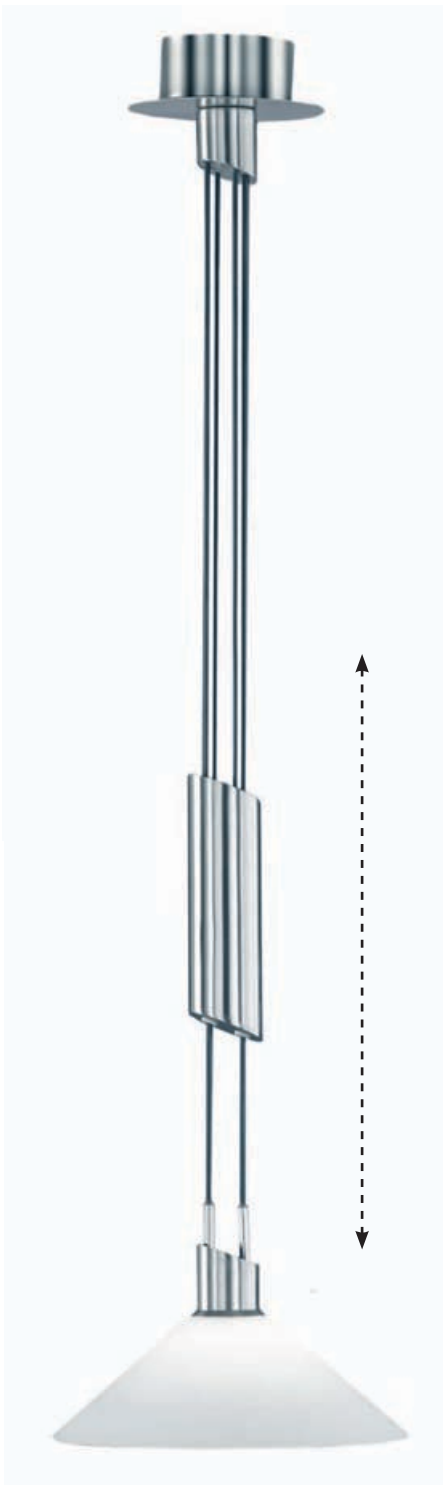

2 Sacramento / Serie 744
6744.01.64.0000
 EAN4003474183220
 Nickel-matt / *Nickel matt finished*

 1 x G9 / 48 W incl.
 2800 K / 1 x 740 lm

Energieeffizienzklasse /
energy efficiency class:

D

Markenleuchtmittel /
branded lamp incl.



↑ 150 cm, ∅ 25 cm
 Glas: weiß satiniert /
Glass: white satin
 Glas / Glass: 7642, ↔ 25 cm



3 Sacramento / Serie 744
7744.02.64.0000
 EAN4003474183237
 Nickel-matt / *Nickel matt finished*

 2 x G9 / 48 W incl.
 2800 K / 2 x 740 lm

Energieeffizienzklasse /
energy efficiency class:

D

Markenleuchtmittel /
branded lamp incl.



↑ 150 cm, ↔ 60 cm
 Glas: weiß satiniert /
Glass: white satin
 Glas / Glass: 7642, ↔ 25 cm



*Zeitlos, aber ewig
 modern*

...Timeless, yet eternally modern

15W
900
Lumen



1 Augusta / Serie 104
6104.01.64.0506
EAN4003474235585
Nickel-matt / *Nickel matt finished*

1 x E27 / 15 W incl.
2700 K / 1 x 900 lm

Energieeffizienzklasse /
energy efficiency class:

A

warm / white

Ø 30 cm, ↓ 150 cm

Glas: Alabasterfarbig /
Glass: *Alabaster coloured*
Glas / Glass: 6098,
↔ 30 cm, ↓ 15 cm



2 Augusta / Serie 104
6104.01.32.0506
EAN4003474236568
Messing-matt / *Brass matt finished*

1 x E27 / 15 W incl.
2700 K / 1 x 900 lm

Energieeffizienzklasse /
energy efficiency class:

A

warm white

Ø 30 cm, ↓ 150 cm

Glas: Alabasterfarbig /
Glass: *Alabaster coloured*
Glas / Glass: 6098,
↔ 30 cm, ↓ 15 cm



33W
460 Lumen

1 Santa Fee / Serie 399
7399.06.64.0000
 EAN4003474192932
 Nickel-matt / Nickel matt finished

Markenleuchtmittel / branded lamp incl.

HALOGEN ECD

↑ 150 cm, ↔ 124 cm, ↗ 34 cm

Glas: Alabasterfarbig / Glass: Alabaster coloured
 Glas / Glass: 7170, Ø 18 cm, ↓ 3,7 cm
 7171, Ø 7,8 cm, ↓ 7,3 cm

6 x G 9 / 33 W incl.
 2700 K / 6 x 460 lm

Energieeffizienzklasse / energy efficiency class:
D

2 Avanti / Serie 298
7298.03.64.0000
 EAN4003474167619
 Nickel-matt / Nickel matt finished

Markenleuchtmittel / branded lamp incl.

HALOGEN ECD

↑ 150 cm, ↔ 66 cm

Glas: Alabasterfarbig / Glass: Alabaster coloured
 Glas / Glass: 7170, Ø 18 cm, ↓ 3,7 cm
 7171, Ø 7,8 cm, ↓ 7,3 cm

3 x G 9 / 33 W incl.
 2700 K / 3 x 460 lm

Energieeffizienzklasse / energy efficiency class:
D

3 Santa Fee / Serie 399
7399.04.64.0000
 EAN4003474180830
 Nickel-matt / Nickel matt finished

Markenleuchtmittel / branded lamp incl.

HALOGEN ECD

↑ 150 cm, ↔ 90 cm, ↗ 34 cm

Glas: Alabasterfarbig / Glass: Alabaster coloured
 7170, Ø 18 cm, ↓ 3,7 cm
 7171, Ø 7,8 cm, ↓ 7,3 cm

4 x G 9 / 33 W incl.
 2700 K / 4 x 460 lm

Energieeffizienzklasse / energy efficiency class:
D

Mali / Serie 204
7204.05.64.0000
 EAN4003474140179
 Nickel-matt /
 Nickel matt finished

geeignet für / suitable for
 Energieeffizienzklasse /
 energy efficiency class:



  5 x E 14 /
 max.40 W

Fit for LED
 ↓ 150 cm, ↔ 105 cm

Glas: opal weiß /
 Glass: opal white
 Glas / Glass: 6424,
 Ø 11,5 cm, ↓ 10 cm



Mali / Serie 204
7204.04.64.0000
 EAN4003474140162
 Nickel-matt /
 Nickel matt finished

geeignet für / suitable for
 Energieeffizienzklasse /
 energy efficiency class:



  4 x E 14 /
 max.40 W

Fit for LED
 ↓ 150 cm, ↔ 81 cm

Glas: opal weiß /
 Glass: opal white
 Glas / Glass:
 6424, Ø 11,5 cm, ↓ 10 cm



3 Mali / Serie 204
7204.03.64.0000
 EAN4003474140155
 Nickel-matt /
 Nickel matt finished

geeignet für / suitable for
 Energieeffizienzklasse /
 energy efficiency class:



  3 x E 14 /
 max.40 W

Fit for LED
 ↓ 150 cm, ↔ 57 cm

Glas: opal weiß /
 Glass: opal white
 Glas / Glass:
 6424, Ø 11,5 cm, ↓ 10 cm



1 Point / Serie 248
6248.01.64.0200
 EAN4003474128733
 Nickel-matt /
Nickel matt finished

geeignet für / suitable for
 Energieeffizienzklasse /
 energy efficiency class:



Fit for LED

Ø 20 cm, ↑ 160 cm

Glas: opal weiß /
 Glass: opal white
 Glas / Glass: 1621

2 Point / Serie 248
6248.01.64.0250
 EAN4003474128740
 Nickel-matt /
Nickel matt finished

geeignet für / suitable for
 Energieeffizienzklasse /
 energy efficiency class:



Fit for LED

Ø 25 cm, ↑ 160 cm

Glas: opal weiß /
 Glass: opal white
 Glas / Glass: 1625

3 Point / Serie 248
6248.01.64.0300
 EAN4003474128757
 Nickel-matt /
Nickel matt finished

geeignet für / suitable for
 Energieeffizienzklasse /
 energy efficiency class:



Fit for LED

Ø 30 cm, ↑ 160 cm

Glas: opal weiß /
 Glass: opal white
 Glas / Glass: 1631

4 Point / Serie 248
6248.01.64.0350
 EAN4003474131450
 Nickel-matt /
Nickel matt finished

geeignet für / suitable for
 Energieeffizienzklasse /
 energy efficiency class:



Fit for LED

Ø 35 cm, ↑ 160 cm

Glas: opal weiß /
 Glass: opal white
 Glas / Glass: 1633

Weitere attraktive Pendelleuchten finden Sie unter der Kategorie „Produktfamilien“ auf folgenden Seiten:
 Additional attractive pendants please find in the category „product families“ on the following pages:



Vannes / Serie 625
 7625.01.01.0000
 Seite / Page 032



Comte / Serie 888
 7888.01.64.0000
 Seite / Page 034



Colmar / Serie 234
 7234.01.01.0000
 Seite / Page 037



Logan / Serie 175
 7175.05.01.0000
 Seite / Page 038



Logan / Serie 175
 7175.07.01.0000
 Seite / Page 039



Louvre / Serie 825
 7825.01.54.0000
 Seite / Page 040



Louvre / Serie 825
 7825.01.54.1000
 Seite / Page 042



Avignon / Serie 275
 7275.01.64.0000
 Seite / Page 044

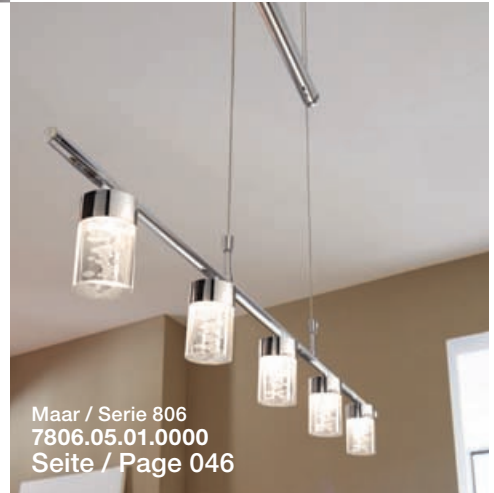

Maar / Serie 806
 7806.05.01.0000
 Seite / Page 046



Luz / Serie 682
 7682.01.64.0500
 Seite / Page 051



Luz / Serie 682
 7682.01.64.1200
 Seite / Page 051



Nero / Serie 277
 6277.05.22.0000
 Seite / Page 053



Nero / Serie 277
6277.05.64.0000
Seite / Page 053



Voss / Serie 379
7379.05.01.0000
Seite / Page 055



Laurids / Serie 889
7889.04.64.0000
Seite / Page 057



Darwin / Serie 613
7613.04.64.0000
Seite / Page 058



Darwin / Serie 613
7613.03.64.0000
Seite / Page 059



Apart / Serie 366
7366.01.64.0000
Seite / Page 060



Mercur / Serie 313
7313.01.01.0000
Seite / Page 061



Avance / Serie 831
7831.04.01.0000
Seite / Page 076



Astro / Serie 360
7360.04.01.0000
Seite / Page 106



Astro / Serie 360
7360.07.01.0000
Seite / Page 106



Stand- und Tischleuchten

...Floor- and table lamps

Solisten für intensive Lichtmomente

Klassisches Design trifft auf die Technologie von Morgen: Mit stilvollen Leuchten, ausgestattet mit neuester Technik, lassen sich einzelne Lichtzonen perfekt gestalten.

Soloists for intense lighting moments

Time-honoured design meets tomorrow's technology: These stylish lights are equipped with the latest technology and allow you to design individual lighting zones within your rooms.

Caja	144
Trond	144
Fin	144
Gerit	144
Yon	145
Point	146
Maxime	148
Minster	148
Savannah	148
Bristol	149
Newton	149
Prescot	150
Pop	151
Campus	152
Liverpool	152
Lux	153
Jet	154
Lou	155
Twin	156
Quincy	158
Eve	160
Ali	161
Angers	162
Vitro	163
Vant	163
Skin	164

weitere Stand- und Tischleuchten
additional floor- and table lamps | 165

LED Light
by **WOFI**

2,5W
220
Lumen

1 Caja / Serie 423
8423.01.10.0000
EAN4003474289564
Schwarz / Black

 1 x LED / 2,5 W incl.
3000 K / 1 x 220 lm

Energieeffizienzklasse /
energy efficiency class:

A+

Markenleuchtmittel /
branded lamp incl.

Ø 12,6 cm, ↑ 31,6 cm

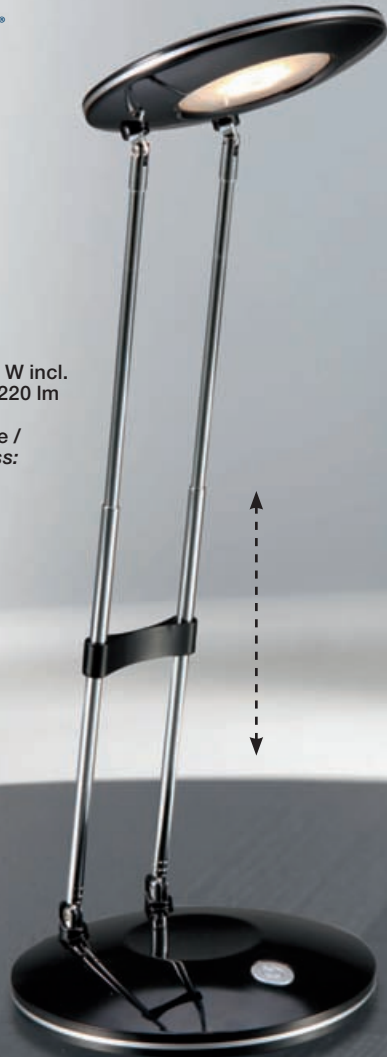

2 Caja / Serie 423
8423.01.06.0000
EAN4003474270418
Weiß / White

 1 x LED / 2,5 W incl.
3000 K / 1 x 220 lm

Energieeffizienzklasse /
energy efficiency class:

A+

Markenleuchtmittel /
branded lamp incl.

Ø 12,6 cm, ↑ 31,6 cm



Neu!

New!

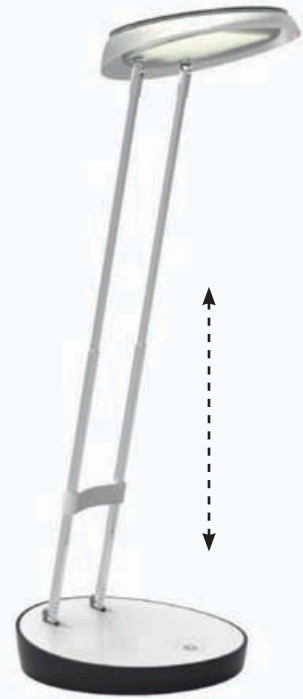

3 Trond / Serie 427
8427.01.06.0000
EAN4003474289571
Weiß / White

 1 x LED / 2,5 W incl.
3000 K / 1 x 220 lm

Energieeffizienzklasse /
energy efficiency class:

A+

Markenleuchtmittel /
branded lamp incl.

Ø 12,6 cm, ↑ 36 cm



2,5W
220
Lumen

2,9W
117
Lumen

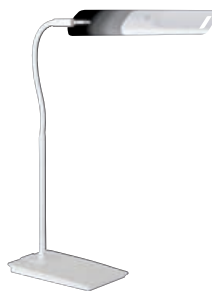

4 Fin / Serie 472
8472.01.06.0000
EAN4003474290386
Weiß / White

 1 x LED / 2,9 W incl.
5500 K / 1 x 117 lm

Energieeffizienzklasse /
energy efficiency class:

A

Markenleuchtmittel /
branded lamp incl.

↑ 30 cm, ⇄ 22 cm

Steckernetzteil mittels USB /
Powersupply with USB

Aufladbare Akkubatterie /
Rechargeable battery

Touch Dimmer / touch dimmer



3W
200
Lumen



5 Gerit / Serie 471
8471.01.10.0000
EAN4003474289601
Schwarz / Black

 1 x LED / 3 W incl.
3000 K / 1 x 200 lm

Energieeffizienzklasse /
energy efficiency class:

A+

Markenleuchtmittel /
branded lamp incl.

Ø 13 cm, ↑ max. 40 cm



New!

New!

1 Yon / Serie 025
8025.01.06.0000
EAN4003474287652
Weiß / White



1 x LED / 5,5 W incl.
3000 K / 1 x 420 lm

Energieeffizienzklasse /
energy efficiency class:

A+

Markenleuchtmittel /
branded lamp incl.

Ø 17 cm, ↑ 37,5 cm, ↳ 22 cm



3-Stufen dimmbar
3-step dimmable

2 Yon / Serie 025
8025.01.70.0000
EAN4003474287676
Silber / Silver



1 x LED / 5,5 W incl.
3000 K / 1 x 420 lm

Energieeffizienzklasse /
energy efficiency class:

A+

Markenleuchtmittel /
branded lamp incl.

Ø 17 cm, ↑ 37,5 cm, ↳ 22 cm



3-Stufen dimmbar
3-step dimmable

3 Yon / Serie 025
8025.01.10.0000
EAN4003474287669
Schwarz / Black



1 x LED / 5,5 W incl.
3000 K / 1 x 420 lm

Energieeffizienzklasse /
energy efficiency class:

A+

Markenleuchtmittel /
branded lamp incl.

Ø 17 cm, ↑ 37,5 cm, ↳ 22 cm



3-Stufen dimmbar
3-step dimmable

5,5W



420
Lumen

Rundum gelungen

...A well-rounded beauty

1 Point / Serie 248
8248.01.06.0200
 EAN4003474128474
 Weiß / White

geeignet für / suitable for
 Energieeffizienzklasse /
 energy efficiency class:



Fit for LED

Ø 20 cm

Glas: opal weiß /
 Glass: opal white



2 Point / Serie 248
8248.01.06.0250
 EAN4003474128481
 Weiß / White

geeignet für / suitable for
 Energieeffizienzklasse /
 energy efficiency class:



Fit for LED

Ø 25 cm

Glas: opal weiß /
 Glass: opal white



3 Point / Serie 248
8248.01.06.0300
 EAN4003474128498
 Weiß / White

geeignet für / suitable for
 Energieeffizienzklasse /
 energy efficiency class:



Fit for LED

Ø 30 cm

Glas: opal weiß /
 Glass: opal white



4 Point / Serie 248
8248.01.06.4200
 EAN4003474228068
 Weiß / White

geeignet für / suitable for
 Energieeffizienzklasse /
 energy efficiency class:



Fit for LED

Ø 20 cm

Glas mit Floraldekor
 Glass with floral pattern





5 Point / Serie 248
6248.01.64.0250
 EAN4003474128740
 Nickel-matt /
 Nickel matt finished

geeignet für / suitable for
 Energieeffizienzklasse /
 energy efficiency class:

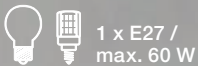

Fit for LED

Ø 25 cm, ↑ 160 cm

Glas: opal weiß /
 Glass: opal white
 Glas / Glass: 1625

6 Point / Serie 248
6248.01.64.0350
 EAN4003474131450
 Nickel-matt /
 Nickel matt finished

geeignet für / suitable for
 Energieeffizienzklasse /
 energy efficiency class:



Fit for LED

Ø 35 cm, ↑ 160 cm

Glas: opal weiß /
 Glass: opal white
 Glas / Glass: 1633

7 Point / Serie 248
6248.01.64.0200
 EAN4003474128733
 Nickel-matt /
 Nickel matt finished

geeignet für / suitable for
 Energieeffizienzklasse /
 energy efficiency class:



Fit for LED

Ø 20 cm, ↑ 160 cm

Glas: opal weiß /
 Glass: opal white
 Glas / Glass: 1621



20 cm

8 Point / Serie 248
6248.01.64.0300
 EAN4003474128757
 Nickel-matt /
 Nickel matt finished

geeignet für / suitable for
 Energieeffizienzklasse /
 energy efficiency class:



Fit for LED

Ø 30 cm, ↑ 160 cm

Glas: opal weiß /
 Glass: opal white
 Glas / Glass: 1631



30 cm



1 Maxime / Serie 041
8041.02.64.0010
 EAN4003474214993
 Nickel-matt /
 Nickel matt finished

 2 x G9 / 33 W incl.
 2700 K / 2 x 460 lm

Energieeffizienzklasse /
 energy efficiency class:

D

Markenleuchtmittel /
 branded lamp incl.



↑ 33 cm, ↔ 25 cm

Glas: opal weiß /
 Glass: opal white
 Glas / Glass: 6064,
 ↔ 25 cm, ↓ 5,2 cm



2 Minster / Serie 687
8687.01.64.0260
 EAN4003474197333
 Nickel-matt /
 Nickel matt finished

 1 x G9 / 33 W incl.
 2700 K / 1 x 460 lm

Energieeffizienzklasse /
 energy efficiency class:

D

Markenleuchtmittel /
 branded lamp incl.



Ø 20 cm, ↑ 26 cm

Glas: Alabasterfarbig /
 Glass: Alabaster coloured
 Glas / Glass: 7806,
 Ø 20 cm, ↓ 5,5 cm



33W

460
 Lumen



3 Savannah / Serie 722
8722.01.64.0006
 EAN4003474228334
 Nickel-matt /
 Nickel matt finished

 1 x E14 / max. 11 W incl.
 2500K/ 1x 660 Lm

Energieeffizienzklasse /
 energy efficiency class:

A

Markenleuchtmittel /
 branded lamp incl.

 warm white

↑ 45 cm

Glas: weiß gewischt
 Glass: white wibe-technique
 Glas / Glass: 7724,
 Ø 18 cm, ↓ 14 cm



11W

660
 Lumen



1 Newton / Serie 112
8112.02.32.0010
 EAN4003474235561
 Messing-matt /
 Brass matt finished

geeignet für / suitable for
 Energieeffizienzklasse /
 energy efficiency class:



 2 x E14 / max.40 W

↑ 39 cm, ↔ 32 cm

Glas: weiß lackiert
 Glass: white lacquered
 Glas / Glass: 6314,
 ↔ 32 cm, ↓ 10,5 cm



2 Bristol / Serie 111
8111.02.64.0510
 EAN4003474235554
 Nickel-matt /
 Nickel matt finished

geeignet für / suitable for
 Energieeffizienzklasse /
 energy efficiency class:



 2 x E14 / max.40 W

Ø 25,5 cm, ↑ 37 cm

Glas: Alabasterfarbig
 Glass: Alabaster coloured
 Glas / Glass: 1360,
 Ø 25,5 cm, ↓ 8,5 cm



3 Newton / Serie 112
8112.02.64.0010
 EAN4003474236308
 Nickel-matt /
 Nickel matt finished

geeignet für / suitable for
 Energieeffizienzklasse /
 energy efficiency class:



 2 x E14 / max.40 W

↑ 39 cm, ↔ 32 cm

Glas: weiß lackiert
 Glass: white lacquered
 Glas / Glass: 6314,
 ↔ 32 cm, ↓ 10,5 cm



4 Bristol / Serie 111
8111.02.32.0510
 EAN4003474236285
 Messing-matt /
 Brass matt finished

geeignet für / suitable for
 Energieeffizienzklasse /
 energy efficiency class:



 2 x E14 / max.40 W

Ø 25,5 cm, ↑ 37 cm

Glas: Alabasterfarbig
 Glass: Alabaster coloured
 Glas / Glass: 1360,
 Ø 25,5 cm, ↓ 8,5 cm





1 Prescott / Serie 747
 8747.02.64.0000
 EAN4003474179568
 Nickel-matt /
 Nickel matt finished

geeignet für / suitable for
 Energieeffizienzklasse /
 energy efficiency class:



 2 x E 14 / max.40 W

Ø 27,5 cm, ↑ 42 cm

Glas: weiß lackiert /
 Glass: white lacquered
 Glas / Glass: 7550,
 Ø 27,5 cm, ↑ 9 cm



Elegante Klassiker

...Elegant classics

2 Prescott / Serie 747
 8747.02.32.0000
 EAN4003474193823
 Messing-matt /
 Brass matt finished

geeignet für / suitable for
 Energieeffizienzklasse /
 energy efficiency class:



 2 x E 14 / max.40 W

Ø 27,5 cm, ↑ 42 cm

Glas: weiß lackiert /
 Glass: white lacquered
 Glas / Glass: 7550,
 Ø 27,5 cm, ↑ 9 cm



3 Prescott / Serie 747
 8747.02.01.0000
 EAN4003474196268
 Chrom / Chrome

geeignet für / suitable for
 Energieeffizienzklasse /
 energy efficiency class:



 2 x E 14 / max.40 W

Ø 27,5 cm, ↑ 42 cm

Glas: weiß lackiert /
 Glass: white lacquered
 Glas / Glass: 7550,
 Ø 27,5 cm, ↑ 9 cm





1 Pop / Serie 865
8865.02.64.0000
 EAN4003474156378
 Nickel-matt /
 Nickel matt finished

geeignet für / suitable for
 Energieeffizienzklasse /
 energy efficiency class:



2 x E14 / max.40 W

Ø 19 cm, ↑ 38 cm

Glas: opal weiß /
 Glass: opal white
 Glas / Glass: 7377,
 Ø 19 cm, ↑ 10 cm



*Es gibt Formen,
 die kann man nicht
 verbessern*

...Some shapes can't be
 improved

2 Pop / Serie 865
8865.02.32.0000
 EAN4003474156361
 Messing-matt /
 Brass matt finished

geeignet für / suitable for
 Energieeffizienzklasse /
 energy efficiency class:



2 x E14 / max.40 W

Ø 19 cm, ↑ 38 cm

Glas: opal weiß /
 Glass: opal white
 Glas / Glass: 7377,
 Ø 19 cm, ↑ 10 cm



1 Campus / Serie 906

3906.01.01.0000

EAN4003474243566

Chrom / Chrome



1 x LED / 5 W incl.
3000 K / 1 x 385 lm

Energieeffizienzklasse /
energy efficiency class:

A+

↑ 184 cm, ⇨ 65 cm



5W

385
Lumen



LED Light
by **WOFI**

Intelligentes Design

...Intelligent design

Um die Ecke gedacht

Unsere Standleuchten sind so ausbalanciert, dass sie praktisch überall ausleuchten können. Eine einfache Handbewegung genügt!

Surprisingly straight forward:

Our floor lamps are balanced so well, you can point them just about anywhere. All it takes is the flick of a wrist.



48W

740
Lumen

2 Liverpool / Serie 343

8343.01.64.0000

EAN4003474207490

Nickel-matt /

Nickel matt finished



1 x G9 / 48 W incl.
2800 K / 1 x 740 lm

Energieeffizienzklasse /
energy efficiency class:

D

Markenleuchtmittel /
branded lamp incl.



↑ 70 cm, ⇨ 40 cm

Glas / Glass: 7950,
Ø12,7 cm



1 Lux / Serie 909
3909.01.01.0000
 EAN4003474244044
 Chrom / Chrome

 1 x LED / 5 W incl.
 3000 K / 1 x 385 lm

Energieeffizienzklasse /
 energy efficiency class:

A+

↑ 175 cm, ⇄ 52 cm



5W

385
 Lumen

2 Lux / Serie 909
8909.01.01.0000
 EAN4003474243719
 Chrom / Chrome

 1 x LED / 5 W incl.
 3000 K / 1 x 385 lm

Energieeffizienzklasse /
 energy efficiency class:

A+

↑ 66 cm, ⇄ 44 cm



LED Light
 by **WOFI**

LED Light
by WOFI

1 Jet / Serie 028
3028.01.64.0000
EAN4003474282978
Nickel-matt / Nickel matt finished



 1 x LED / 10 W incl.
3000 K / 1 x 605 lm

Energieeffizienzklasse /
energy efficiency class:

A

Markenleuchtmittel /
branded lamp incl.

↑ 152 cm, ↔ 16 cm, ⇄ 60 cm

  3-Stufen dimmbar
3-step dimmable



8W

455
Lumen

New!
New!

10W

605
Lumen

Zeitlose Accessoires

...timeless accessories

2 Jet / Serie 028
8028.01.64.0000
EAN4003474282961
Nickel-matt / Nickel matt finished



 1 x LED / 8 W incl.
3000 K / 1 x 455 lm

Energieeffizienzklasse /
energy efficiency class:

A

Markenleuchtmittel /
branded lamp incl.

↑ 64 cm, ⇄ 60 cm

  3-Stufen dimmbar
3-step dimmable



1 Lou / Serie 468
8468.01.32.0000
EAN4003474069524
Messing-matt / Brass matt finished

 1 x LED / 6 W incl.
1 x 540 lm

Energieeffizienzklasse /
energy efficiency class:

A⁺

Markenleuchtmittel /
branded lamp incl.

∫ 50 cm, ⇨ 56 cm

Glas / Glass: 3028, Ø 13 cm



stufenlos dimmbar / *infinitely dimmable*

Memory Funktion / *memory function*

inkl. Farbtemperaturwechsler /
incl. Colour temperature changer



2 Lou / Serie 468
8468.01.64.0000
EAN4003474271804
Nickel-matt / Nickel matt finished

 1 x LED / 6 W incl.
1 x 540 lm

Energieeffizienzklasse /
energy efficiency class:

A⁺

Markenleuchtmittel /
branded lamp incl.

∫ 50 cm, ⇨ 56 cm

Glas / Glass: 3028, Ø 13 cm



stufenlos dimmbar / *infinitely dimmable*

Memory Funktion / *memory function*

inkl. Farbtemperaturwechsler /
incl. Colour temperature changer

6W

540
Lumen

3 Lou / Serie 468
3468.01.32.0000
EAN4003474285924
Messing-matt / Brass matt finished

 1 x LED / 6 W incl.
1 x 540 lm

Energieeffizienzklasse /
energy efficiency class:

A⁺

Markenleuchtmittel /
branded lamp incl.

Ø 25 cm, ∫ 138 cm, ⇨ 62 cm

Glas / Glass: 6584, Ø 17 cm



stufenlos dimmbar / *infinitely dimmable*

Memory Funktion / *memory function*

inkl. Farbtemperaturwechsler /
incl. Colour temperature changer

Neu!
Neu!

4 Lou / Serie 468
3468.01.64.0000
EAN4003474271798
Nickel-matt / Nickel matt finished

 1 x LED / 6 W incl.
1 x 540 lm

Energieeffizienzklasse /
energy efficiency class:

A⁺

Markenleuchtmittel /
branded lamp incl.

Ø 25 cm, ∫ 138 cm, ⇨ 62 cm

Glas / Glass: 6584, Ø 17 cm



stufenlos dimmbar / *infinitely dimmable*

Memory Funktion / *memory function*

inkl. Farbtemperaturwechsler /
incl. Colour temperature changer

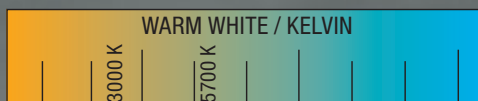

1 Twin / Serie 006
3006.02.32.9000
 EAN4003474260372
 Messing-matt / Brass matt finished



2 x LED / 4,6 W incl.
 3000 K / 2 x 400 lm

Energieeffizienzklasse /
 energy efficiency class:



↑ 157 cm, ⇨ 47 cm

Glas / Glass: 6518, Ø 13 cm



2 Twin / Serie 006
3006.02.64.9000
 EAN4003474264745
 Nickel-matt /
 Nickel matt finished



2 x LED / 4,6 W incl.
 3000 K / 2 x 400 lm

Energieeffizienzklasse /
 energy efficiency class:



↑ 157 cm, ⇨ 47 cm

Glas / Glass: 6518, Ø 13 cm



4,6W

400
 Lumen



3 Twin / Serie 006
8006.01.64.9500
 EAN4003474264752
 Nickel-matt /
 Nickel matt finished



1 x LED / 4,6 W incl.
 3000 K / 1 x 400 lm

Energieeffizienzklasse /
 energy efficiency class:



↑ 55 cm, ⇨ 32 cm

Glas / Glass: 6518,
 Ø 13 cm



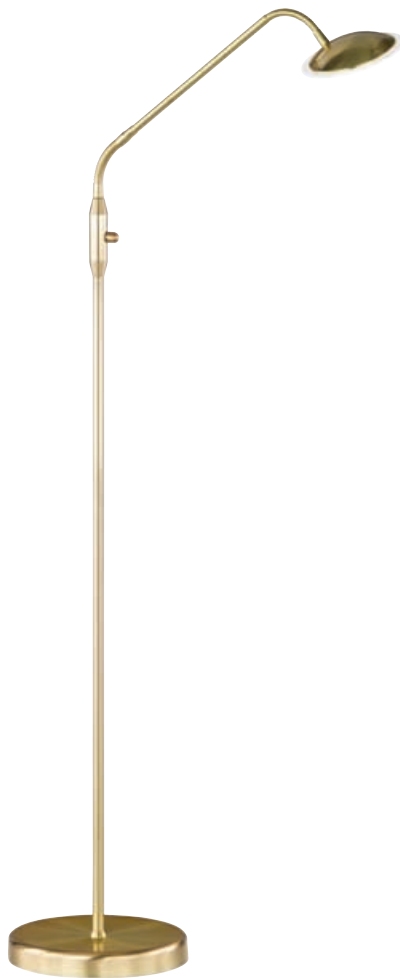

4 Twin / Serie 006
3006.01.32.9000
EAN4003474261898
Messing-matt / Brass matt finished

 1 x LED / 4,6 W incl.
3000 K / 1 x 400 lm

Energieeffizienzklasse /
energy efficiency class:

A+

↑ 157 cm, ⇨ 47 cm

Glas / Glass: 6518, Ø 13 cm

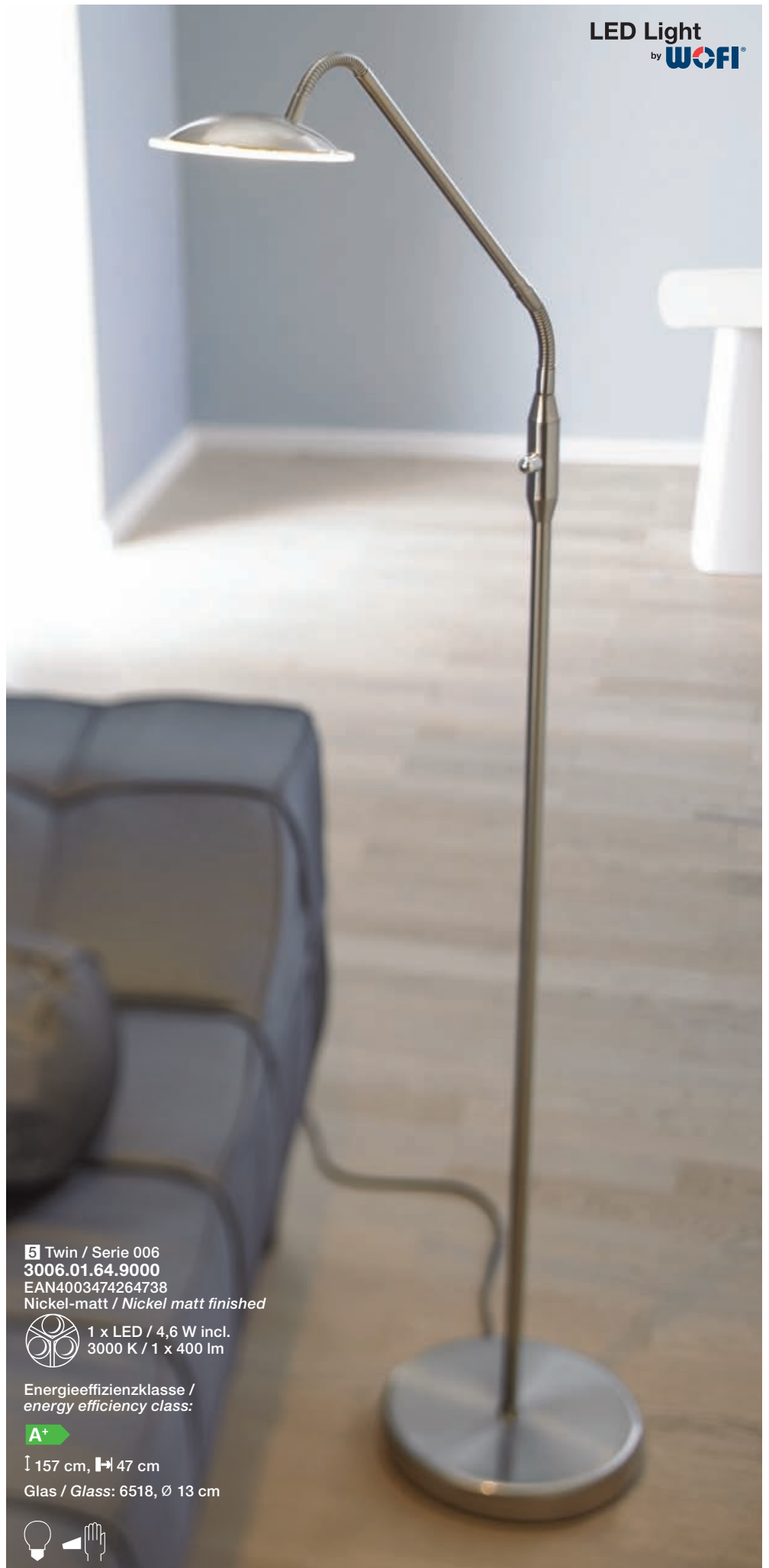

5 Twin / Serie 006
3006.01.64.9000
EAN4003474264738
Nickel-matt / Nickel matt finished

 1 x LED / 4,6 W incl.
3000 K / 1 x 400 lm

Energieeffizienzklasse /
energy efficiency class:

A+

↑ 157 cm, ⇨ 47 cm

Glas / Glass: 6518, Ø 13 cm



LED Light
by **WOFI**



1 Quincy / Serie 116
3116.03.06.0000
EAN4003474250960
Weiß / White



3 x GU10 / 2,4 W incl.
3500 K / 3 x 210 lm

Energieeffizienzklasse /
energy efficiency class:

A++

↑ 143 cm, ↔ 28 cm



2 Quincy / Serie 116
3116.03.01.0000
EAN4003474250953
Chrom / Chrome



3 x GU10 / 2,4 W incl.
3500 K / 3 x 210 lm

Energieeffizienzklasse /
energy efficiency class:

A++

↑ 143 cm, ↔ 28 cm



Charmante Spots

...Charming spots

3 Quincy / Serie 116
8116.01.06.0000
 EAN4003474251110
 Weiß / White



1 x GU10 / 2,4 W incl.
 3500 K / 1 x 210 lm

Energieeffizienzklasse /
 energy efficiency class:

A++

↑ 49 cm, ↔ 14 cm



4 Quincy / Serie 116
8116.01.01.0000
 EAN4003474251097
 Chrom / Chrome



1 x GU10 / 2,4 W incl.
 3500 K / 1 x 210 lm

Energieeffizienzklasse /
 energy efficiency class:

A++

↑ 49 cm, ↔ 14 cm



LED-Spots in Bestform

Die Serie QUINCY überzeugt durch gutes Aussehen und eine intelligente Drehvorrichtung.

LED spots in top shape

The QUINCY series combines great looks with an intelligent pivoting mechanism.

2,4W

210
 Lumen



5W
400
Lumen



LED Light
by WOFI

Neu!
Neu!

5W
400
Lumen

1 Eve / Serie 361
3361.02.09.0000
EAN4003474281339
Antik braun / *Antique brown*

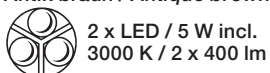

Energieeffizienzklasse /
energy efficiency class:

A+

Markenleuchtmittel /
branded lamp incl.

Ø 24,5 cm, ↑ 130 cm, ⇨ 35 cm

Glas / Glass: 6622

Ø 8 cm



2 Eve / Serie 361
3361.01.09.0000
EAN4003474281315
Antik braun / *Antique brown*

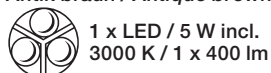

Energieeffizienzklasse /
energy efficiency class:

A+

Markenleuchtmittel /
branded lamp incl.

Ø 24,5 cm, ↑ 130 cm, ⇨ 35 cm

Glas / Glass: 6622

Ø 8 cm



3 Eve / Serie 361
3361.02.64.0000
EAN4003474281322
Nickel-matt /
Nickel matt finished



Energieeffizienzklasse /
energy efficiency class:

A+

Markenleuchtmittel /
branded lamp incl.

Ø 24,5 cm, ↑ 130 cm, ⇨ 35 cm

Glas / Glass: 6622, Ø 8 cm



4 Eve / Serie 361
3361.01.64.0000
EAN4003474281308
Nickel-matt /
Nickel matt finished



Energieeffizienzklasse /
energy efficiency class:

A+

Markenleuchtmittel /
branded lamp incl.

Ø 24,5 cm, ↑ 130 cm,
⇨ 35 cm

Glas / Glass: 6622, Ø 8 cm





1 Ali / Serie 840
3840.01.64.0000
 EAN4003474156842
 Nickel-matt /
 Nickel matt finished

 1 x G9 / 33 W incl.
 2700 K / 1 x 460 lm

Energieeffizienzklasse /
 energy efficiency class:

D

Markenleuchtmittel /
 branded lamp incl.

**HALOGEN
 EDP**

∟ 150 cm, ⇨ 40 cm
 Glas: Alabasterfarbig /
 Glass: Alabaster coloured
 Glas / Glass: 7157, Ø 7,5 cm



2 Ali / Serie 840
3840.02.64.0000
 EAN4003474156859
 Nickel-matt /
 Nickel matt finished

 2 x G9 / 33 W incl.
 2700 K / 2 x 460 lm

Energieeffizienzklasse /
 energy efficiency class:

D

Markenleuchtmittel /
 branded lamp incl.

**HALOGEN
 EDP**

∟ 156 cm, ⇨ 40 cm

Glas: alabasterfarbig /
 Glass: Alabaster coloured
 Glas / Glass: 7157, Ø 7,5 cm



33W

460
 Lumen



LED Light
by WOFI®

New!
New!

6624
6182

1 Angers / Serie 330
3330.02.54.0000
EAN4003474287287
Nickel-matt / Chrom /
Nickel matt finished / Chrome

1 x LED / 36 W incl.
3000 K / 1 x 3240 lm

1 x LED / 5 W incl.
3000 K / 1 x 450 lm

Energieeffizienzklasse /
energy efficiency class:

A+

Markenleuchtmittel / branded lamp incl.

∫ 180 cm, Ø 45 cm

Glas / Glass:
6182: Ø 45 cm
6624: Ø 40 cm
7599: Ø 12 cm

getrennt schaltbar / dimmbar / separately
switchable / dimmable



2 Angers / Serie 330
3330.02.32.0000
EAN4003474287270
Messing-matt / Brass matt finished

1 x LED / 36 W incl.
2700 K / 1 x 3240 lm

1 x LED / 5 W incl.
2700 K / 1 x 450 lm

Energieeffizienzklasse /
energy efficiency class:

A+

Markenleuchtmittel /
branded lamp incl.

∫ 180 cm, Ø 45 cm

Glas / Glass:
6182: Ø 45 cm
6624: Ø 40 cm
7599: Ø 12 cm

getrennt schaltbar /
dimmbar / separately
switchable / dimmable



LED Light
by **WOFI**



Neu!
Neu!

18W
1600 Lumen

5W
400 Lumen

1 Vitro / Serie 317
3317.02.64.0000
EAN4003474281100
Nickel-matt /
Nickel matt finished

1 x LED / 18 W incl.
3000 K / 1 x 1600 lm

1 x LED / 5 W incl.
3000 K / 1 x 400 lm

Energieeffizienzklasse /
energy efficiency class:
A+

Markenleuchtmittel /
branded lamp incl.

Ø 28 cm, | 180 cm, | 35 cm

Glas / Glass:
6597: Ø 28 cm
6598: Ø 10 cm
6602: Ø 4,5 cm

getrennt schaltbar /
dimmbar / separately
switchable / dimmable

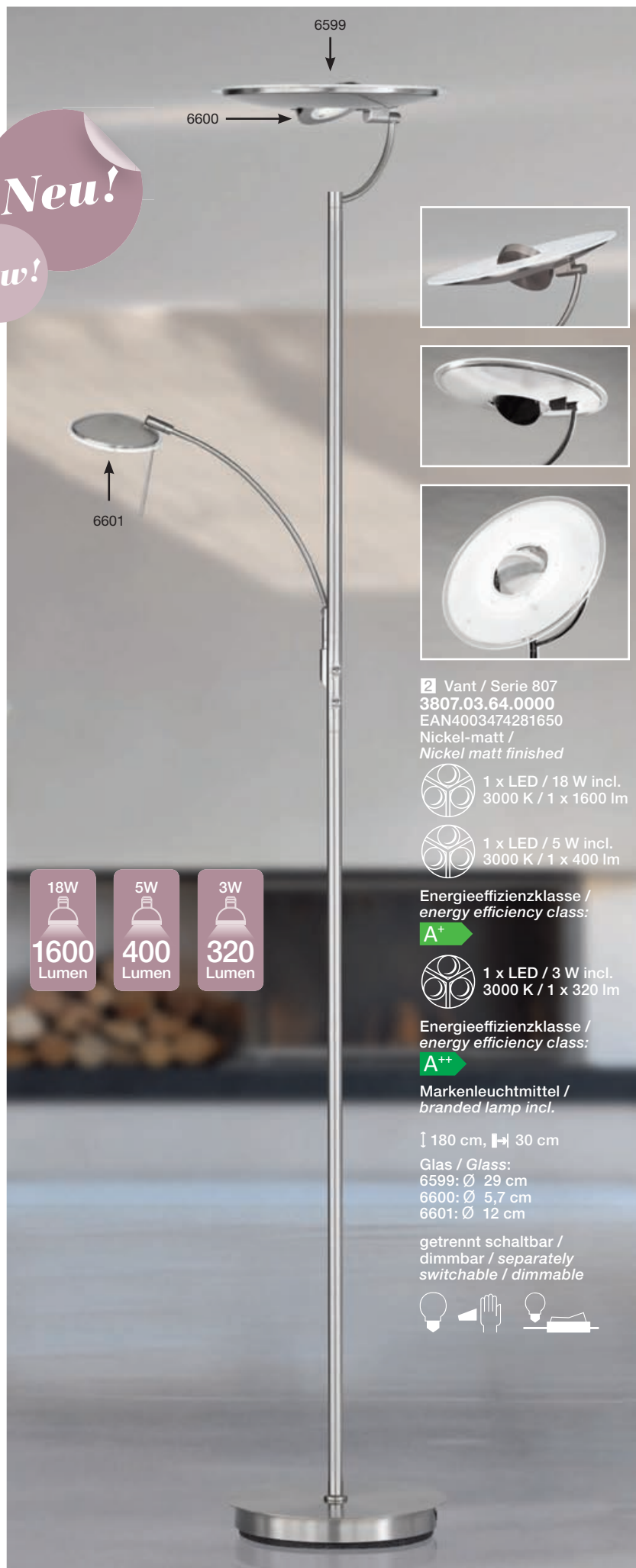

2 Vant / Serie 807
3807.03.64.0000
EAN4003474281650
Nickel-matt /
Nickel matt finished

1 x LED / 18 W incl.
3000 K / 1 x 1600 lm

1 x LED / 5 W incl.
3000 K / 1 x 400 lm

Energieeffizienzklasse /
energy efficiency class:
A+

1 x LED / 3 W incl.
3000 K / 1 x 320 lm

Energieeffizienzklasse /
energy efficiency class:
A++

Markenleuchtmittel /
branded lamp incl.

| 180 cm, | 30 cm

Glas / Glass:
6599: Ø 29 cm
6600: Ø 5,7 cm
6601: Ø 12 cm

getrennt schaltbar /
dimmbar / separately
switchable / dimmable





1 Skin / Serie 389
3389.02.64.0000
 EAN4003474168265
 Nickel-matt /
 Nickel matt finished

 1 x R7S / 230 W incl.
 2950 K / 1 x 5000 lm

Energieeffizienzklasse /
 energy efficiency class:

C

 1 x G9 / 33 W incl.
 2700K / 1 x 460 lm

Energieeffizienzklasse /
 energy efficiency class:

D

Markenleuchtmittel /
 branded lamp incl.



↑ 180 cm, ⇨ 45 cm

Glas: Alabasterfarbig
 Glass: Alabaster coloured
 Glas / Glass:
 7378 / 7353 / 7352 / 7178



2 Skin / Serie 389
3389.02.02.3000
 EAN4003474169569
 Messing-gefärbt /
 Coloured brass

 1 x R7S / 230 W incl.
 2950 K / 1 x 5000 lm

Energieeffizienzklasse /
 energy efficiency class:

C

 1 x G9 / 33 W incl.
 2700K / 1 x 460 lm

Energieeffizienzklasse /
 energy efficiency class:

D

Markenleuchtmittel /
 branded lamp incl.



↑ 180 cm, ⇨ 45 cm

Glas: Alabasterfarbig getönt
 Glass: Alabaster
 coloured / shaded
 Glas / Glass:
 7464 / 7463 / 7352 / 7462



3 Skin / Serie 389
3389.02.09.3000
 EAN4003474169729
 Antik braun /
 Antique brown

 1 x R7S / 230 W incl.
 2950 K / 1 x 5000 lm

Energieeffizienzklasse /
 energy efficiency class:

C

 1 x G9 / 33 W incl.
 2700K / 1 x 460 lm

Energieeffizienzklasse /
 energy efficiency class:

D

Markenleuchtmittel /
 branded lamp incl.



↑ 180 cm, ⇨ 45 cm

Glas: Alabaster-
 farbig getönt
 Glass: Alabaster
 coloured / shaded
 Glas / Glass:
 7464 / 7463 / 7352 / 7462



230W

5000
 Lumen

33W

460
 Lumen

Weitere attraktive Steh- und Tischleuchten finden Sie unter der Kategorie „Produktfamilien“ auf folgenden Seiten:

Additional attractive floor- and table lamps please find in the category „product families“ on the following pages:



Voss / Serie 379
3379.01.01.0000
Seite / Page 054



Voss / Serie 379
3379.02.54.0000
Seite / Page 054

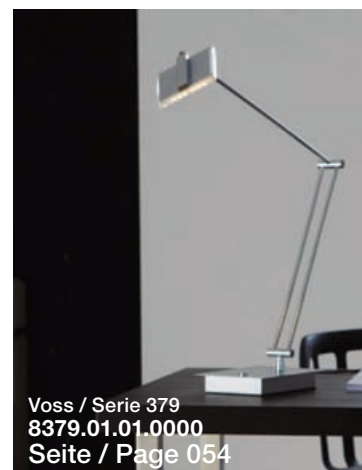

Voss / Serie 379
8379.01.01.0000
Seite / Page 054



Laurids / Serie 889
3889.01.64.0000
Seite / Page 056



Laurids / Serie 889
8889.01.64.0000
Seite / Page 056



Darwin / Serie 613
3613.01.64.0000
Seite / Page 058



Darwin / Serie 613
8613.01.64.0000
Seite / Page 058

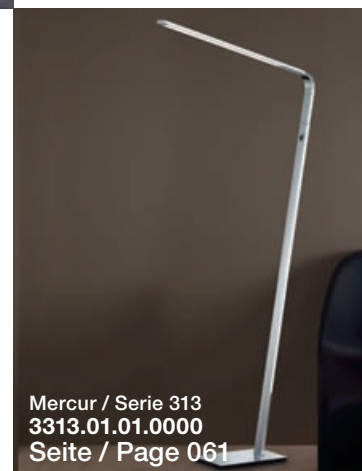

Mercur / Serie 313
3313.01.01.0000
Seite / Page 061



Mercur / Serie 313
8313.01.01.0000
Seite / Page 061



Orbit / Serie 946
3946.01.01.0000
Seite / Page 063

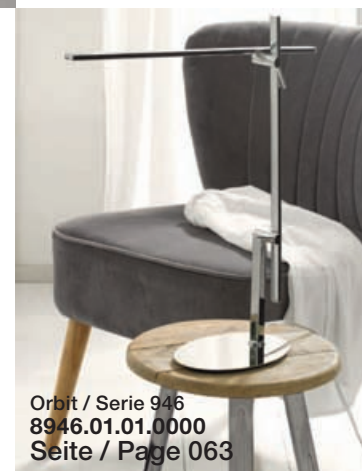

Orbit / Serie 946
8946.01.01.0000
Seite / Page 063



Deventer / Serie 449
3449.01.01.0000
Seite / Page 109



Deventer / Serie 449
8449.01.01.0000
Seite / Page 109



Wand- und Deckenleuchten

...Wall and ceiling lights

Leuchten mit Vision

Sie lassen Räume größer wirken oder Flure breiter: Das Licht unserer Wand- und Deckenleuchten beeinflusst die räumliche Wahrnehmung. In moderner, klassischer oder avantgardistischer Ausführung.

Lamps with a vision

They make rooms seem bigger and hallways seem wider: the light from our wall and ceiling lights influences depth perception. Available in modern, classic and avant-garde styles.

Soul		168
Everett		169
Cholet		170
Chloe		171
Space		172
Rondo		173
Reims		174
Lore		174
Mira		175
Midu		176
Kent		177
Lorient		178
Sphinx		180
Leda		181
Jaden		182
Sila		183
Liv		184
Mile		186
Modo		187
Nancy		188
Tuva		190
Less		190
Parc		191
Etana		192
Divina		194
Braez		195
Via		196
Vetro		197
Velo		197
Luv		198
Kanpur		199
Figio		199
Eddy		200
Buddy		200
Zibo		200
Prince		201
Aqaba		201

weitere Wand- und Deckenleuchten
/ additional wall- and ceiling lamps | 202

Licht in Balance: flache Optik – runder Gesamteindruck

...Balanced lighting: a flat look for
a well-rounded impression



LED Light
by **WOFI**



1 Soul / Serie 117
9117.01.54.0000
EAN4003474291031
Nickel-matt / Chrom /
Nickel matt finished / Chrome



1 x LED / 44 W incl.
3000 K / 1 x 3000 lm

↔ 61 cm, ↗ 55 cm, ⚓ 7,4 cm

Dimmbar mittels geeignetem
Wanddimmer / dimmable by
suitable wall dimmer



Energieeffizienzklasse /
energy efficiency class:

A →



1 Everett / Serie 067
9067.08.64.0000
 EAN4003474291024
 Nickel-matt /
 Nickel matt finished

 8 x LED / 3 W incl.
 3000 K / 8 x 270 lm

Energieeffizienzklasse /
 energy efficiency class:

A⁺

Markenleuchtmittel /
 branded lamp incl.

↑ 66,5 cm, ↔ 66,5 cm,
 ↓ 10,5 cm

Glas / Glass: 1409,
 Ø 10,5 cm

3W

270
 Lumen

New!
New!



LED Light
 by **WOFI**

2 Everett / Serie 067
9067.06.64.0000
 EAN4003474291000
 Nickel-matt /
 Nickel matt finished

 6 x LED / 3 W incl.
 3000 K / 6 x 270 lm

Energieeffizienzklasse /
 energy efficiency class:

A⁺

Markenleuchtmittel /
 branded lamp incl.

↑ 57 cm, ↔ 57 cm, ↓ 10 cm

Glas / Glass: 1409,
 Ø 10,5 cm

5W

300
Lumen

1 Cholet / Serie 197
9197.09.64.0000
EAN4003474281155
Nickel-matt /
Nickel matt finished

 9 x LED / 5 W incl.
3000 K / 9 x 300 lm

Energieeffizienzklasse /
energy efficiency class:

A

Markenleuchtmittel /
branded lamp incl.

↑ 35 cm, ↔ 35 cm, ⊥ 11,5 cm

Glas / Glass: 6503,
↑ 8 cm, ↔ 8 cm



8 cm

Neu!

Neu!



2 Cholet / Serie 197
9197.05.64.0000
EAN4003474281148
Nickel-matt /
Nickel matt finished

 5 x LED / 5 W incl.
3000 K / 5 x 300 lm

Energieeffizienzklasse /
energy efficiency class:

A

Markenleuchtmittel /
branded lamp incl.

↑ 28 cm, ↔ 28 cm, ⊥ 11,5 cm

Glas / Glass: 6503,
↑ 8 cm, ↔ 8 cm



1 Chloe / Serie 195
9195.06.01.0000
 EAN4003474281599
 Chrom / Chrome



6 x LED / 5 W incl.
 3000 K / 6 x 300 lm

Energieeffizienzklasse /
 energy efficiency class:



Markenleuchtmittel /
 branded lamp incl.

Ø 35 cm, 10 cm



New!
New!

2 Chloe / Serie 195
9195.04.01.0000
 EAN4003474283746
 Chrom / Chrome



4 x LED / 5 W incl.
 3000 K / 4 x 300 lm

Energieeffizienzklasse /
 energy efficiency class:



Markenleuchtmittel /
 branded lamp incl.

Ø 30 cm, 10 cm



LED Light
by **WOFI**



1 Space / Serie 216
9216.04.01.0000
EAN4003474289793
Chrom / Chrome



4 x LED / 6 W incl.
3000 K / 4 x 550 lm

Energieeffizienzklasse /
energy efficiency class:



Markenleuchtmittel /
branded lamp incl.

↓ 30 cm, ↔ 30 cm, ↓ 7,5 cm

Dimmbar mittels geeignetem
Wanddimmer / dimmable by
suitable wall dimmer



6W

550
Lumen

Modern, ungewöhnlich, reizvoll!

Die Form- und Farbgestaltung der Serie SPACE ist auffallend schön und zugleich wirkungsvoll.

Modern, unusual, delightful!

The shape and colour design of the series SPACE is strikingly beautiful while effectively.



2 Space / Serie 216
7216.02.01.0000
EAN4003474289762
Chrom / Chrome



2 x LED / 6 W incl.
3000 K / 2 x 550 lm

Energieeffizienzklasse /
energy efficiency class:



Markenleuchtmittel /
branded lamp incl.

↓ 14 cm, ↔ 30 cm, ↓ 6 cm



3 Space / Serie 216
4216.01.01.0000
EAN4003474110004
Chrom / Chrome



1 x LED / 6 W incl.
3000 K / 1 x 550 lm

Energieeffizienzklasse /
energy efficiency class:



Markenleuchtmittel /
branded lamp incl.

↓ 14 cm, ↔ 14 cm, ↓ 6 cm

1 Rondo / Serie 671
9671.01.06.0000
 EAN4003474287102
 Weiß / White



1 x LED / 13 W incl.
 3000 K / 1 x 750 lm

Energieeffizienzklasse /
 energy efficiency class:

A

Markenleuchtmittel /
 branded lamp incl.

Ø 30 cm, **±** 6 cm



LED Light
 by **WOLFF**



Neu!

Neu!

*Design muss nicht
 immer kompliziert sein*
 ...Design doesn't need to be complicated

2 Rondo / Serie 671
9671.01.06.0500
 EAN4003474287119
 Weiß / White



1 x LED / 19 W incl.
 3000 K / 1 x 1170 lm

Energieeffizienzklasse /
 energy efficiency class:

A

Markenleuchtmittel /
 branded lamp incl.

Ø 50 cm, **±** 6 cm



LED Light
by **WOFI**



3W
200
Lumen

1 Reims / Serie 272
9272.09.01.0000
EAN4003474281971
Chrom / Chrome

 9 x LED / 3 W incl.
3000 K / 9 x 200 lm

Energieeffizienzklasse /
energy efficiency class:

A+

Markenleuchtmittel /
branded lamp incl.

↓ 40 cm, ↔ 40 cm, ⊥ 8 cm

Glas / Glass: 6577,
↓ 36 cm, ↔ 36 cm

Neu!
Neu!



2 Reims / Serie 272
9272.04.01.0000
EAN4003474281964
Chrom / Chrome

 4 x LED / 3 W incl.
3000 K / 4 x 200 lm

Energieeffizienzklasse /
energy efficiency class:

A+

Markenleuchtmittel /
branded lamp incl.

↓ 25 cm, ↔ 25 cm, ⊥ 8 cm

Glas / Glass: 6576,
↓ 22 cm, ↔ 22 cm



3 Lore / Serie 624
9624.05.01.0320
EAN4003474290379
Chrom / Chrome

 5 x LED / 3 W incl.
3000 K / 5 x 260 lm

Energieeffizienzklasse /
energy efficiency class:

A+

Markenleuchtmittel /
branded lamp incl.

Ø 32 cm, ⊥ 9 cm

Glas / Glass: 3002, Ø 30 cm

3W
260
Lumen

LED Light
by **WOFI**



1 Mira / Serie 475
4475.01.01.0000
EAN4003474277714
Chrom / Chrome

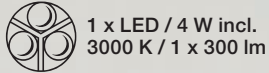

Energieeffizienzklasse /
energy efficiency class:

A⁺

Markenleuchtmittel /
branded lamp incl.

↔ 15 cm, ↓ 15 cm, ⇨ 6 cm

Glas / Glass: 6560

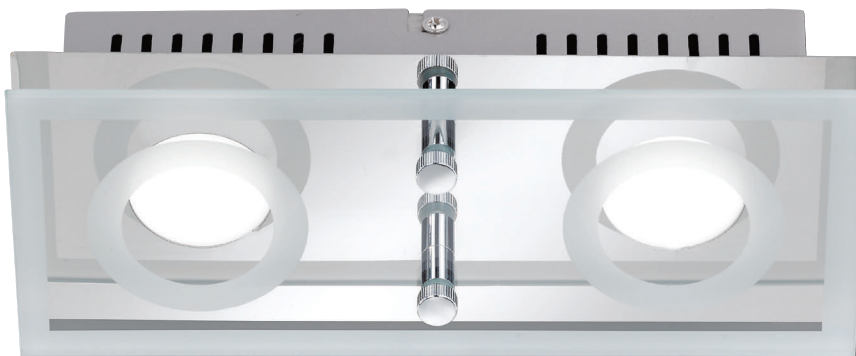
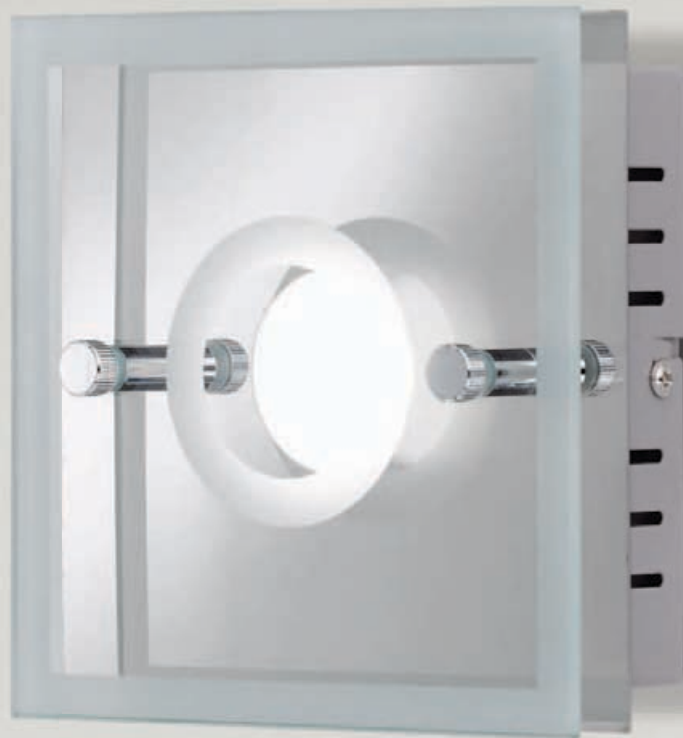

2 Mira / Serie 475
7475.02.01.0000
EAN4003474277721
Chrom / Chrome

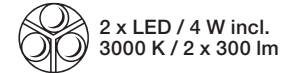

Energieeffizienzklasse /
energy efficiency class:

A⁺

Markenleuchtmittel /
branded lamp incl.

↔ 25 cm, ↓ 10 cm, ⇩ 7 cm

Glas / Glass: 6561



3 Mira / Serie 475
9475.04.01.0000
EAN4003474277738
Chrom / Chrome

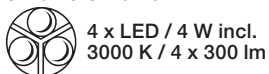

Energieeffizienzklasse /
energy efficiency class:

A⁺

Markenleuchtmittel /
branded lamp incl.

↔ 25 cm, ↓ 25 cm, ⇩ 7 cm

Glas / Glass: 6562





1 Midu / Serie 193
4193.01.01.0000
EAN4003474280714
Chrom / Chrome



1 x LED / 5 W incl.
3000 K / 1 x 430 lm

Energieeffizienzklasse /
energy efficiency class:



Markenleuchtmittel /
branded lamp incl.

↑ 23 cm, ↔ 8,5 cm, ⇨ 14 cm

Glas / Glass: 6609, Ø 3,6 cm,
↑ 8,2 cm



2 Midu / Serie 193
9193.03.01.0000
EAN4003474280738
Chrom / Chrome



3 x LED / 5 W incl.
3000 K / 3 x 430 lm

Energieeffizienzklasse /
energy efficiency class:



Markenleuchtmittel /
branded lamp incl.

Ø 43,5 cm, ↑ 14,6 cm

Glas / Glass: 6609, Ø 3,6 cm,
↑ 8,2 cm

LED Light
by WOFI®



5W
380
Lumen

1 Kent / Serie 060

9060.06.01.0000

EAN4003474283272

Chrom / Chrome



6 x LED / 5 W incl.
3000 K / 6 x 380 lm

Energieeffizienzklasse /
energy efficiency class:

A+

Markenleuchtmittel /
branded lamp incl.

Ø 25 cm, H 16 cm

Glas / Glass: 1406, Ø 4 cm,
H 10 cm

Neu!

Neu!

2 Midu / Serie 193

9193.06.01.0000

EAN4003474281124

Chrom / Chrome



6 x LED / 5 W incl.
3000 K / 6 x 430 lm

Energieeffizienzklasse /
energy efficiency class:

A+

Markenleuchtmittel /
branded lamp incl.

Ø 45,6 cm, H 14,5 cm

Glas / Glass: 6609,
Ø 3,6 cm, H 8,2 cm

5W
430
Lumen





1 Lorient / Serie 848
9848.06.54.0000
 EAN4003474289724
 Nickel-matt / Chrom /
 Nickel matt finished / Chrome



6 x LED / 4 W incl.
 3000 K / 6 x 400 lm

Energieeffizienzklasse /
 energy efficiency class:



Markenleuchtmittel /
 branded lamp incl.

↔ 76,5 cm, ↗ 9 cm, ↓ 7,5 cm

Glas: Acryl / Glass: Acrylic
 Glas / Glass: 6620, Ø 5 cm, ↓ 2,3 cm

LED Light
 by **WOLFF**



2 Lorient / Serie 848
4848.01.54.0000
 EAN4003474289694
 Nickel-matt / Chrom /
 Nickel matt finished / Chrome



1 x LED / 4 W incl.
 3000 K / 1 x 400 lm

Markenleuchtmittel /
 branded lamp incl.

↑ 11 cm, ↔ 11 cm, ⇨ 7 cm

Glas: Acryl / Glass: Acrylic
 Glas / Glass: 6620, Ø 5 cm,
 ↓ 2,3 cm



Energieeffizienzklasse /
 energy efficiency class:



3 Lorient / Serie 848
7848.03.54.0000
 EAN4003474138046
 Nickel-matt / Chrom /
 Nickel matt finished / Chrome



3 x LED / 4 W incl.
 3000 K / 3 x 400 lm

Energieeffizienzklasse /
 energy efficiency class:



Markenleuchtmittel /
 branded lamp incl.

↑ 9 cm, ↔ 36 cm, ↓ 7,5 cm

Glas: Acryl / Glass: Acrylic
 Glas / Glass: 6620, Ø 5 cm,
 ↓ 2,3 cm



Neu!

Neu!

Beleuchtung auf den Punkt gebracht

...Getting to the heart of lighting

Spot an für
schnörkelloses
Design

Acryl und Chrom als leuchtendes
Beispiel für Harmonie.

No frills design
takes the spotlight

Acrylic and chrome in shining harmony.



4 Lorient / Serie 848
9848.05.54.0000
EAN4003474289700
Nickel-matt / Chrom /
Nickel matt finished / Chrome



5 x LED / 4 W incl.
3000 K / 5 x 400 lm

Energieeffizienzklasse /
energy efficiency class:

A+

Markenleuchtmittel /
branded lamp incl.

∟ 30 cm, ↔ 30 cm, ⊥ 7,5 cm

Glas: Acryl / Glass: Acrylic
Glas / Glass: 6620, Ø 5 cm, ∟ 2,3 cm

1 Sphinx / Serie 102
9102.09.01.0000
EAN4003474283876
Chrom / Chrome



9 x LED / 5 W incl.
3000 K / 9 x 420 lm

Energieeffizienzklasse /
energy efficiency class:



Markenleuchtmittel /
branded lamp incl.

↑ 39 cm, ↔ 39 cm, ⊥ 7,5 cm

Glas / Glass: 6301,
↔ 39 cm, ⊥ 39 cm



LED-Technologie im Quadrat

... LED technology, squared



2 Sphinx / Serie 102
9102.05.01.0000
EAN4003474280691
Chrom / Chrome



5 x LED / 5 W incl.
3000 K / 5 x 420 lm

Energieeffizienzklasse /
energy efficiency class:



Markenleuchtmittel /
branded lamp incl.

↑ 30 cm, ↔ 30 cm, ⊥ 7,5 cm

Glas / Glass: 6300,
↔ 30 cm, ⊥ 30 cm



Modernes Design, verbunden mit innovativer
LED-Technologie – die Deckenleuchten der
Serie SPHINX.

Modern design, combined with modern LED
technology: that's the essence of the SPHINX
series.



1 Leda / Serie 511
4511.02.01.0000
EAN4003474272320
Chrom / Chrome



2 x LED / 3 W incl.
3000 K / 2 x 260 lm

Energieeffizienzklasse /
energy efficiency class:

A+

Markenleuchtmittel /
branded lamp incl.

∏ 13 cm , ↔ 44 cm , ≡ 7 cm

Glas: weiß lackiert mit Klarrand /
Glass: white laquered with
clear border
Glas / Glass: 6281: 18 x 13 cm



2 Leda / Serie 511
4511.01.01.0000
EAN4003474272337
Chrom / Chrome



1 x LED / 3 W incl.
3000 K / 1 x 260 lm

Energieeffizienzklasse /
energy efficiency class:

A+

Markenleuchtmittel /
branded lamp incl.

∏ 16 cm , ↔ 21 cm , ≡ 7 cm

Glas: weiß lackiert
mit Klarrand /
Glass: white laquered
with clear border
Glas / Glass: 6273: 21 x 16 cm



Da wird jedes Zimmer zur lichten Komfortzone

Mit frechem Design und modernen
Materialien wird hier in jeder Ecke
für echte Ausstrahlung gesorgt.

Every room turns into a comfort zone

With bright designs and modern
materials every corner of the room
lights up beautifully.

56W
4000
Lumen

1 Jaden / Serie 662
9662.01.06.0680
EAN4003474287812
Weiß / White

 1 x LED / 56 W incl.
1 x 4000 lm

Energieeffizienzklasse /
energy efficiency class:

A

Markenleuchtmittel /
branded lamp incl.

Ø 68 cm, 12,5 cm



inkl. Farbtemperaturwechsler /
incl. colour temperature changer

inkl. Nachtlicht und Schlafmodus /
incl. night light mode and sleep mode

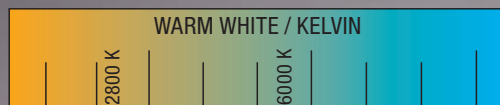

Die Kunst des Weglassens

Perfekte Kombination aus weißem Acrylglas und transparentem Glasrand.

Focused on the essentials

A perfect combination of white acrylic glass and a transparent glass pane.



37W
2800
Lumen

182

Premium Product of WOFI Germany



2 Jaden / Serie 662
9662.01.06.0510
EAN4003474287829
Weiß / White

 1 x LED / 37 W incl.
1 x 2800 lm

Energieeffizienzklasse /
energy efficiency class:

A

Markenleuchtmittel /
branded lamp incl.

Ø 51 cm, 9 cm



inkl. Farbtemperaturwechsler /
incl. colour temperature changer

inkl. Nachtlicht und Schlafmodus /
incl. night light mode and sleep mode



1 Sila / Serie 350
9350.01.64.0000
EAN4003474263533
Nickel-matt /
Nickel matt finished



1 x LED / 72 W incl.
1 x 5100 lm

Energieeffizienzklasse /
energy efficiency class:

A

Ø 60 cm, \pm 6 cm



72W
5100
Lumen

Jede Farbtemperatur ist zusätzlich in 4-Stufen dimmbar (25%, 50%, 75%, 100%). Zusatzfunktion: Nachtlicht!

Each color temperature can be additionally dimmed in 4 steps (25%, 50%, 75%, 100%). Additional function: nightlight!



3000 K



4200 K



5000 K



6000 K



Diese Leuchte ist besonders gut gelungen

Die flache, runde Form lässt SILA ultra-modern wirken. Das weiße Gehäuse verbreitet ein angenehmes Licht. Die Fernbedienung ermöglicht eine Regulierung der Farbtemperatur und der Helligkeit.

This lamp turned out especially well

The flat round shape gives SILA an ultra modern appearance. Its white case spreads a pleasant, soft light. And the remote control enables you to regulate light and the brightness at the push of a button.

2 Sila / Serie 350
9350.01.64.0400
EAN4003474263854
Nickel-matt / Nickel matt finished



1 x LED / 40 W incl.
1 x 2500 lm

Energieeffizienzklasse / energy efficiency class:

A

Ø 45 cm, \pm 9,5 cm



40W
2500
Lumen

50W
4000
Lumen



Neu!
Neu!

Die setzen Sie ins rechte Licht

Jede Persönlichkeit hat Ecken und Kanten. Diese Deckenleuchten bestechen durch Charakter und die schöne Möglichkeit, zusätzlich zum Wandschalter per Fernbedienung mehrere LED-Panels in einem Raum zu schalten und zu dimmen.

Show them in their true light

Each personality is different. These ceiling lamps impress with their character and the optional attraction, aside from the wall switch, of controlling and dimming more LED-panels in a room by remote control.

1 Liv / Serie 693
9693.01.70.5200
EAN4003474286235
Silber / Silver

 1 x LED / 50 W incl.
1 x 4000 lm

Energieeffizienzklasse /
energy efficiency class:

A

↓ 60 cm, ↔ 120 cm, ↓ 5,5 cm



inkl. Farbtemperaturwechsler
stufenlos 2800 - 6800 K /
incl. colour temperature changer
infinitely 2800 - 6800 K

50W
4000
Lumen

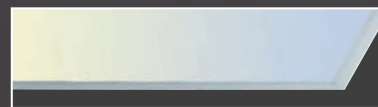

Variante ohne Farbtemperaturwechsler: Version without colour temperature changer:

2 Liv / Serie 693
9693.01.70.1200
EAN4003474265643
Silber / Silver

 1 x LED / 75 W incl.
3000 K / 1 x 5600 lm

Energieeffizienzklasse /
energy efficiency class:

A

↓ 60 cm, ↔ 120 cm, ↓ 5,5 cm



75W
5600
Lumen



3 Liv / Serie 693
9693.01.70.5600
 EAN4003474286228
 Silber / Silver



1 x LED / 44 W incl.
 1 x 3400 lm

44W

3400
 Lumen

Energieeffizienzklasse /
 energy efficiency class:

A

↓ 60 cm, ↔ 60 cm, ↓ 5,5 cm



inkl. Farbtemperaturwechsler
 stufenlos 2800 - 6800 K /

*incl. colour temperature changer infinitely
 2800 - 6800 K*

**Variante ohne Farbtemperatur-
 wechsler / Version without colour
 temperature changer**

4 Liv / Serie 693
9693.01.70.0600
 EAN4003474265636
 Silber / Silver



1 x LED / 64 W incl.
 3000 K / 1 x 4630 lm

64W

4630
 Lumen

Energieeffizienzklasse /
 energy efficiency class:

A

↓ 60 cm, ↔ 60 cm, ↓ 5,5 cm



5 Liv / Serie 693
9693.01.70.5300
 EAN4003474286211
 Silber / Silver



1 x LED / 24 W incl.
 1 x 1500 lm

24W

1500
 Lumen

Energieeffizienzklasse /
 energy efficiency class:

A

↓ 30 cm, ↔ 30 cm, ↓ 5,5 cm



inkl. Farbtemperaturwechsler
 stufenlos 2800 - 6800 K /

*incl. colour temperature changer
 infinitely 2800 - 6800 K*

**Variante ohne Farbtemperaturwechsler
 Version without colour temperature
 changer**

6 Liv / Serie 693
9693.01.70.0300
 EAN4003474265629
 Silber / Silver



1 x LED / 31 W incl.
 3000 K / 1 x 2070 lm

31W

2070
 Lumen

Energieeffizienzklasse /
 energy efficiency class:

A

↓ 30 cm, ↔ 30 cm, ↓ 5,5 cm



LED Light
by **WOFI**

1 Mile / Serie 030
9030.01.64.0400
EAN4003474286709
Nickel-matt / Nickel matt finished



1 x LED / 16 W incl.
3000 K / 1 x 1150 lm



Energieeffizienzklasse /
energy efficiency class:

A

Markenleuchtmittel /
branded lamp incl.

Ø 40 cm, H 14 cm

Glas / Glass: 1419



New!

New!

Design fürs Dasein
...Design for living with

2 Mile / Serie 030
9030.01.64.0300
EAN4003474286693
Nickel-matt / Nickel matt finished



1 x LED / 11 W incl.
3000 K / 1 x 820 lm

Energieeffizienzklasse /
energy efficiency class:

A

Markenleuchtmittel /
branded lamp incl.

Ø 30 cm, H 11 cm

Glas / Glass: 1522





27W
2160
Lumen

1 Modo / Serie 547
9547.01.64.0400
EAN4003474284415
Nickel-matt /
Nickel matt finished



1 x LED / 27 W incl.
3000 K / 1 x 2160 lm

Energieeffizienzklasse /
energy efficiency class:

A

Markenleuchtmittel /
branded lamp incl.

Ø 50 cm, H 13,5 cm

Glas / Glass: 1424

Dimmbar mittels geeignetem
Wanddimmer / dimmable by
suitable wall dimmer



Licht für die Sinne

...Lighting that appeals to the senses

New!

New!

18W
1440
Lumen

2 Modo / Serie 547
9547.01.64.0300
EAN4003474284408
Nickel-matt /
Nickel matt finished



1 x LED / 18 W incl.
3000 K / 1 x 1440 lm

Energieeffizienzklasse /
energy efficiency class:

A

Markenleuchtmittel /
branded lamp incl.

Ø 38 cm, H 12 cm

Glas / Glass: 1423



Leuchten, die Akzente setzen

... Lamps that create accents



Neu!
New!

1 Nancy / Serie 276
9276.01.01.0200
EAN4003474280820
Chrom / Chrome



1 x LED / 7,5 W incl.
3000 K / 1 x 650 lm

Energieeffizienzklasse /
energy efficiency class:

A⁺

Markenleuchtmittel /
branded lamp incl.

Ø 20 cm, **H** 7,2 cm

Glas / Glass: 6589, Ø 20 cm
6590, Ø 15 cm

LED Light
by **WOFI**

7,5W

650
Lumen

17,5W

1550
Lumen



2 Nancy / Serie 276
9276.01.01.0300
EAN4003474280844
Chrom / Chrome



1 x LED / 17,5 W incl.
3000 K / 1 x 1550 lm

Energieeffizienzklasse /
energy efficiency class:

A⁺

Markenleuchtmittel /
branded lamp incl.

Ø 30 cm, **H** 7,2 cm

Glas / Glass: 6591, Ø 30 cm
6592, Ø 24 cm

17,5W
1550
Lumen



1 Nancy / Serie 276
9276.01.01.1300
EAN4003474280943
Chrom / Chrome



1 x LED / 17,5 W incl.
3000 K / 1 x 1550 lm

Energieeffizienzklasse /
energy efficiency class:

A+

Markenleuchtmittel /
branded lamp incl.

↓ 28 cm, ↔ 28 cm, ⊥ 7,2 cm

Glas / Glass: 6595, 28 x 28 cm
6596, 22 x 22 cm

Neu!

Neu!



Leuchten für Generationen

Zukunftsweisende Technologie verknüpft mit schlichter und klassischer Eleganz.

Lighting for generations

Cutting edge technology combined with simple and classic elegance.

2 Nancy / Serie 276
9276.01.01.1200
EAN4003474280929
Chrom / Chrome



1 x LED / 7,5 W incl.
3000 K / 1 x 650 lm

Energieeffizienzklasse /
energy efficiency class:

A+

Markenleuchtmittel /
branded lamp incl.

↓ 18 cm, ↔ 18 cm, ⊥ 7,2 cm

Glas / Glass:
6593, 18 x 18 cm
6594, 13 x 13 cm

7,5W

650
Lumen

12W
1200
Lumen



1 Less / Serie 720
4720.01.64.0000
EAN4003474151960
Nickel-matt / *Nickel matt finished*



1 x LED / 12 W incl.
3000 K / 1 x 1200 lm

Energieeffizienzklasse /
energy efficiency class:

A⁺

Markenleuchtmittel /
branded lamp incl.

↑ 15,5 cm, ↔ 32 cm, ⇨ 6 cm

Ultra Weißglas /
Ultra white glass
Glas / *Glass*: 6152



Optisches Understatement

...Visual understatement

2 Tuva / Serie 184
4184.01.64.0000
EAN4003474274065
Nickel-matt /
Nickel matt finished



1 x LED / 5 W incl.
3000 K / 1 x 420 lm

Energieeffizienzklasse /
energy efficiency class:

A⁺

Markenleuchtmittel /
branded lamp incl.

↑ 21 cm, ↔ 12 cm,
⇨ 9,5 cm



3 Tuva / Serie 184
4184.01.06.0000
EAN4003474269375
Weiß / *White*



1 x LED / 5 W incl.
3000 K / 1 x 420 lm

Energieeffizienzklasse /
energy efficiency class:

A⁺

Markenleuchtmittel /
branded lamp incl.

↑ 21 cm, ↔ 12 cm,
⇨ 9,5 cm



5W
420
Lumen



LED Light
by **WOFI**



1 Parc / Serie 187
4187.01.64.0000
EAN4003474154442
Nickel-matt /
Nickel matt finished



1 x LED / 9 W incl.
3000 K / 1 x 810 lm

Energieeffizienzklasse /
energy efficiency class:

A⁺

Markenleuchtmittel /
branded lamp incl.

↑ 30 cm, → 12,5 cm

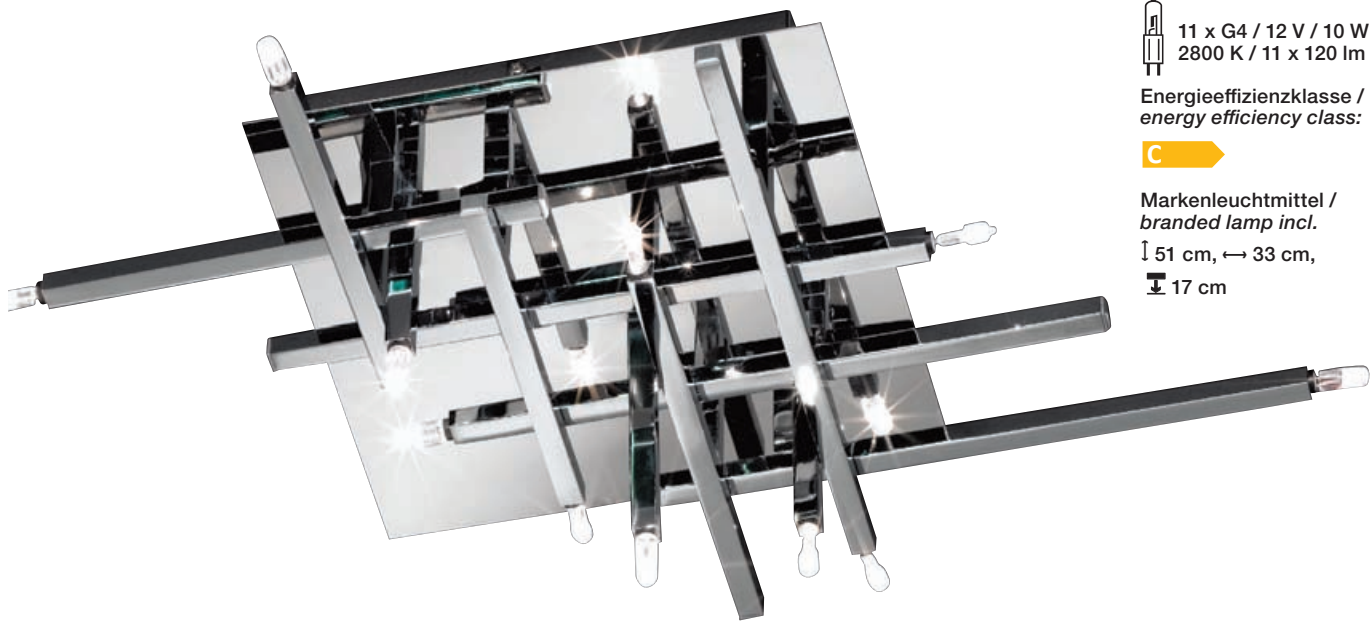

1 Etana / Serie 007
9007.11.01.0000
EAN4003474215907
Chrom / Chrome



11 x G4 / 12 V / 10 W incl.
2800 K / 11 x 120 lm

Energieeffizienzklasse /
energy efficiency class:

C

Markenleuchtmittel /
branded lamp incl.

↓ 51 cm, ↔ 33 cm,
⊥ 17 cm

10W

120
Lumen

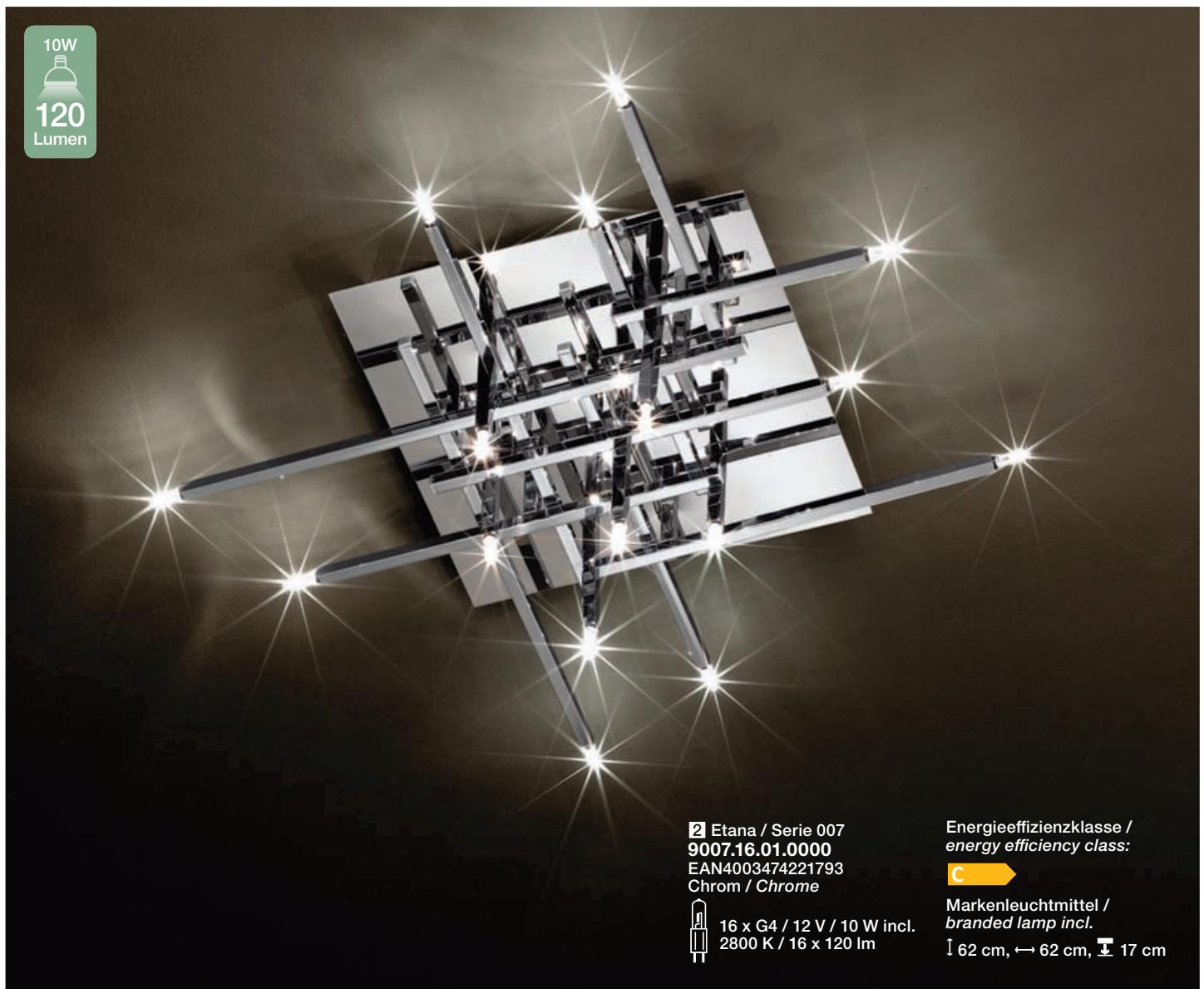

2 Etana / Serie 007
9007.16.01.0000
EAN4003474221793
Chrom / Chrome



16 x G4 / 12 V / 10 W incl.
2800 K / 16 x 120 lm

Energieeffizienzklasse /
energy efficiency class:

C

Markenleuchtmittel /
branded lamp incl.

↓ 62 cm, ↔ 62 cm, ⊥ 17 cm



3 Etana / Serie 007
4007.05.01.0000
 EAN4003474215884
 Chrom / Chrome



5 x G4 / 12 V / 10 W incl.
 2800 K / 5 x 120 lm

Energieeffizienzklasse /
 energy efficiency class:

C

Markenleuchtmittel /
 branded lamp incl.

↑ 48 cm, ↔ 33 cm, ⇨ 8 cm

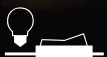



*Sie strahlen
innere Balance aus*
...They radiate inner balance

1 Divina / Serie 425
4425.01.01.0000
EAN4003474261072
Chrom / Chrome

geeignet für / suitable for
Energieeffizienzklasse /
energy efficiency class:

A++  **E**

  1 x E14 / max. 42 W



Fit for LED

↑ 18 cm, ↔ 17,5 cm,
▬ 12 cm

2 Divina / Serie 425
4425.01.06.0000
EAN4003474261065
Weiß / White

geeignet für / suitable for
Energieeffizienzklasse /
energy efficiency class:

A++  **E**

  1 x E14 / max. 42 W

Fit for LED

↑ 18 cm, ↔ 17,5 cm, ▬ 12 cm

Spiralen bestehen aus ineinanderlaufenden Rundungen, die alle Blicke automatisch auf sich ziehen. So werden die schönen Wandleuchten der Serie Divina zu einem optischen Magneten, den man immer wieder aufs Neue betrachten kann.

Spirals consist of tapering circular lines which automatically draw the eye. Which turns sconces from the DIVINA line into visual magnets you'll enjoy seeing over and over again.



1 Braez / Serie 581
4581.02.64.0000
EAN4003474259352
Nickel-matt /
Nickel matt finished

 2 x G9 / 33 W incl.
2700 K / 2 x 460 lm

Energieeffizienzklasse /
energy efficiency class:

D

Markenleuchtmittel /
branded lamp incl.



┌ 22 cm, ↔ 7,5 cm, ┆ 7,5 cm

33W

460
Lumen



2 Braez / Serie 581
4581.02.01.0000
EAN4003474260259
Chrom / Chrome

 2 x G9 / 33 W incl.
2700 K / 2 x 460 lm

Energieeffizienzklasse /
energy efficiency class:

D

Markenleuchtmittel /
branded lamp incl.



┌ 22 cm, ↔ 7,5 cm, ┆ 7,5 cm

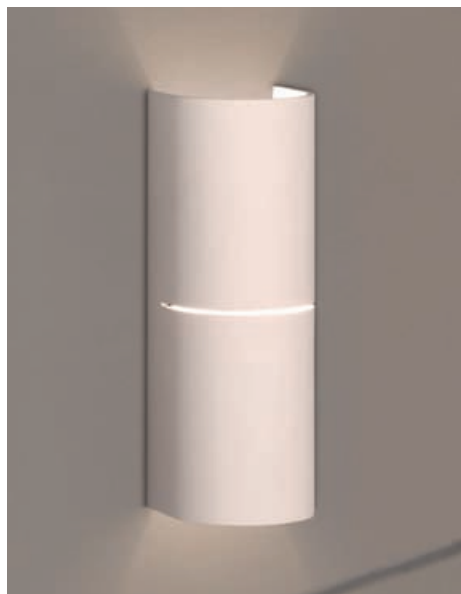

3 Braez / Serie 581
4581.02.06.0000
EAN4003474259376
Weiß / White

 2 x G9 / 33 W incl.
2700 K / 2 x 460 lm

Energieeffizienzklasse /
energy efficiency class:

D

Markenleuchtmittel /
branded lamp incl.



┌ 22 cm, ↔ 7,5 cm, ┆ 7,5 cm

Zaubern Strahlenkreuze an die Wand

...Radiant crosses appear on your wall

1 Via / Serie 679
4679.01.01.0000
EAN4003474253664
Chrom / Chrome

 1 x G9 / 33 W incl.
2700 K / 1 x 460 lm

Energieeffizienzklasse /
energy efficiency class:

D

Markenleuchtmittel /
branded lamp incl.

 HALOGEN
EDP

┌ 20,5 cm, ┆ 8,5 cm

33W

460
Lumen



Klein, aber Oho

Die kleinen VIA Wandleuchten, in gebürstetem Aluminium oder Chrom, erzielen äußerst effektive Lichteffekte mit ihrem warm-weißen Halogenlicht.

Small but impressive

Our tiny VIA wall-mounted spotlights, available in brushed aluminium or chrome, create gorgeous light effects with their warm, white halogen light.

2 Via / Serie 679
4679.01.63.0000
EAN4003474253671
Aluminium gebürstet /
aluminium brass finished

 1 x G9 / 33 W incl.
2700 K / 1 x 460 lm

Energieeffizienzklasse /
energy efficiency class:

D

Markenleuchtmittel /
branded lamp incl.

 HALOGEN
EDP

┌ 20,5 cm, ┆ 8,5 cm



Design von morgen für Räume von heute

...Tomorrow's designs for
the rooms of today



120W
2250
Lumen

1 Velo / Serie 096
4096.01.64.0000
EAN4003474126111
Nickel-matt /
Nickel matt finished

1 x R7S / 120 W incl.
2950 K / 1 x 2250 lm

Energieeffizienzklasse /
energy efficiency class:

C

Markenleuchtmittel /
branded lamp incl.

↔ 32 cm, ↓ 16 cm, ⇨ 7 cm

Glas: weiß satiniert /
Glass: white satin
Glas / Glass: 7373 / 7372

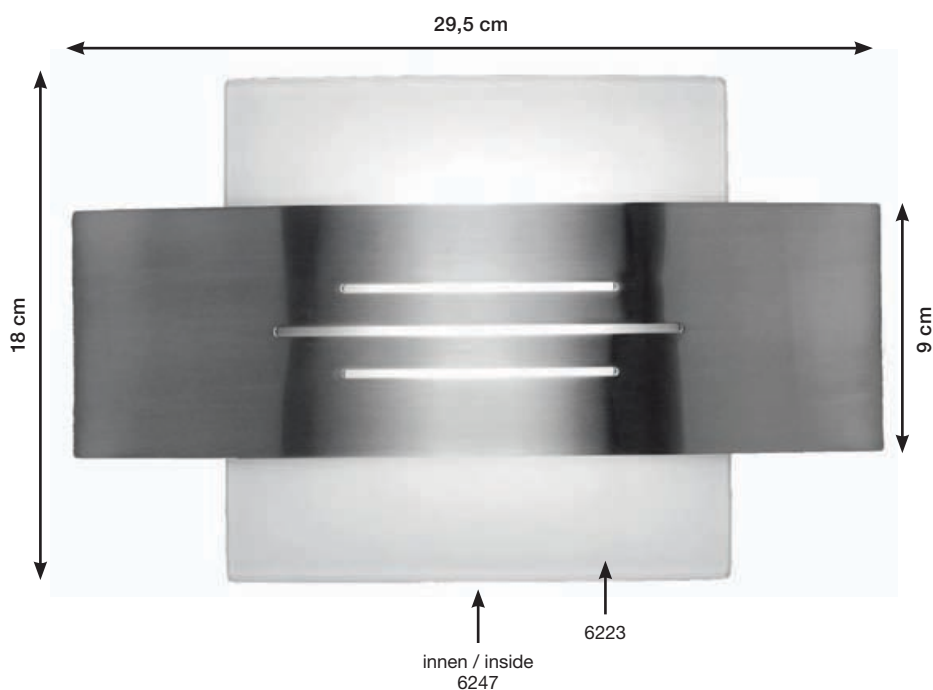

80W
1400
Lumen

2 Vetro / Serie 236
4236.01.64.0000
EAN4003474227108
Nickel-matt /
Nickel matt finished

1 x R7S / 80 W incl.
2900 K / 1 x 1400 lm

Energieeffizienzklasse /
energy efficiency class:

C

Markenleuchtmittel /
branded lamp incl.

↓ 18 cm, ↔ 29,5 cm, ⇨ 8,5 cm

Glas: weiß satiniert /
Glass: white satin
Glas / Glass: 6223,
↔ 18 cm, ↓ 18 cm,



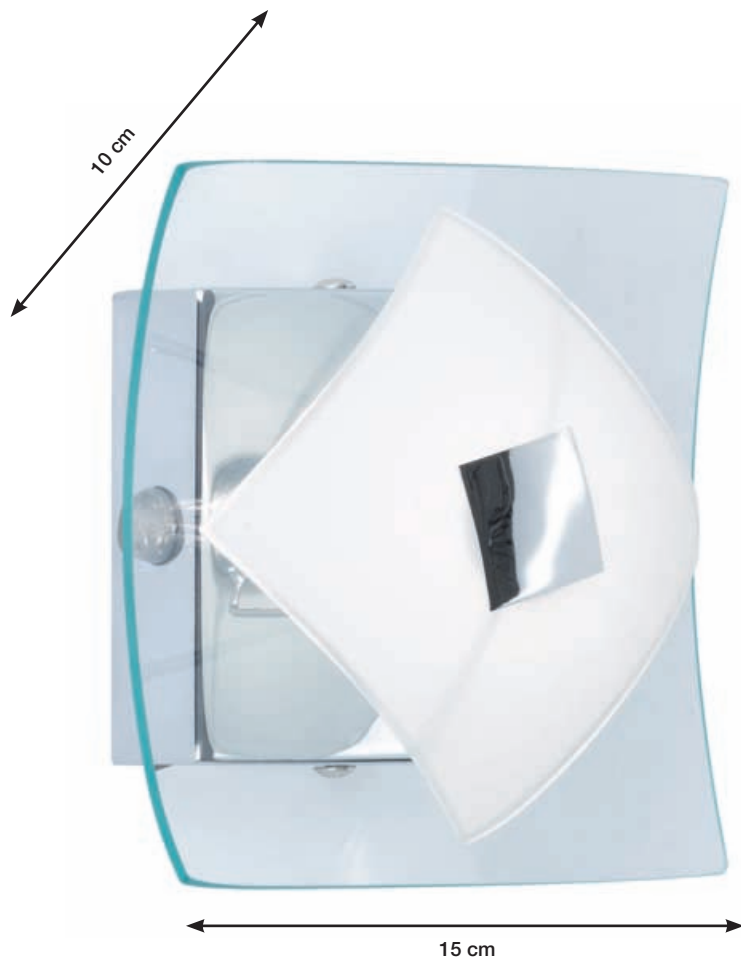

1 Luv / Serie 641
4641.01.01.0000
 EAN4003474269290
 Chrom / Chrome



1 x G9 / 33 W incl.
 2700 K / 1 x 460 lm

Energieeffizienzklasse /
 energy efficiency class:



Markenleuchtmittel /
 branded lamp incl.



↑ 15 cm , ↔ 15 cm,
 ▮ 8 cm

Glas / Glass:
 6154: 15 x 15 cm
 6155: 10 x 10 cm



Luxus bis in die kleinste Ecke

...Luxury in every corner

2 Luv / Serie 641
7641.02.01.0000
 EAN4003474269306
 Chrom / Chrome



2 x G9 / 33 W incl.
 2700 K / 2 x 460 lm

Energieeffizienzklasse /
 energy efficiency class:



Markenleuchtmittel /
 branded lamp incl.



↑ 15 cm , ↔ 32 cm,
 ▮ 8 cm

Glas / Glass:
 6154: 15 x 15 cm
 6155: 10 x 10 cm

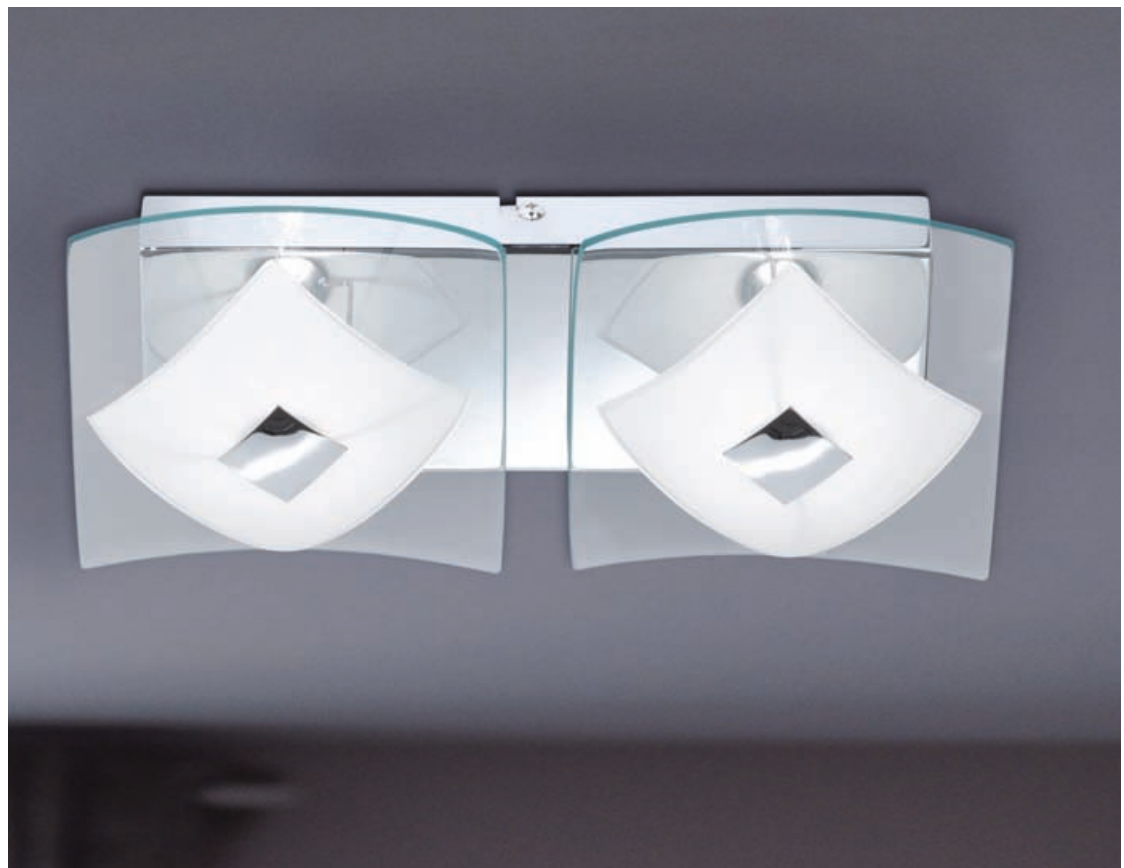

1 Kanpur / Serie 419**9419.02.64.0280**

EAN4003474182452

Nickel-matt /

Nickel matt finished

geeignet für / suitable for
Energieeffizienzklasse /
energy efficiency class:2 x E14 /
max. 40 W

Fit for LED

↓ 28 cm, ↔ 28 cm,
↳ 8 cm

Glas / Glass:

7615 / 28 x 28 cm

7616 / 21 x 21 cm

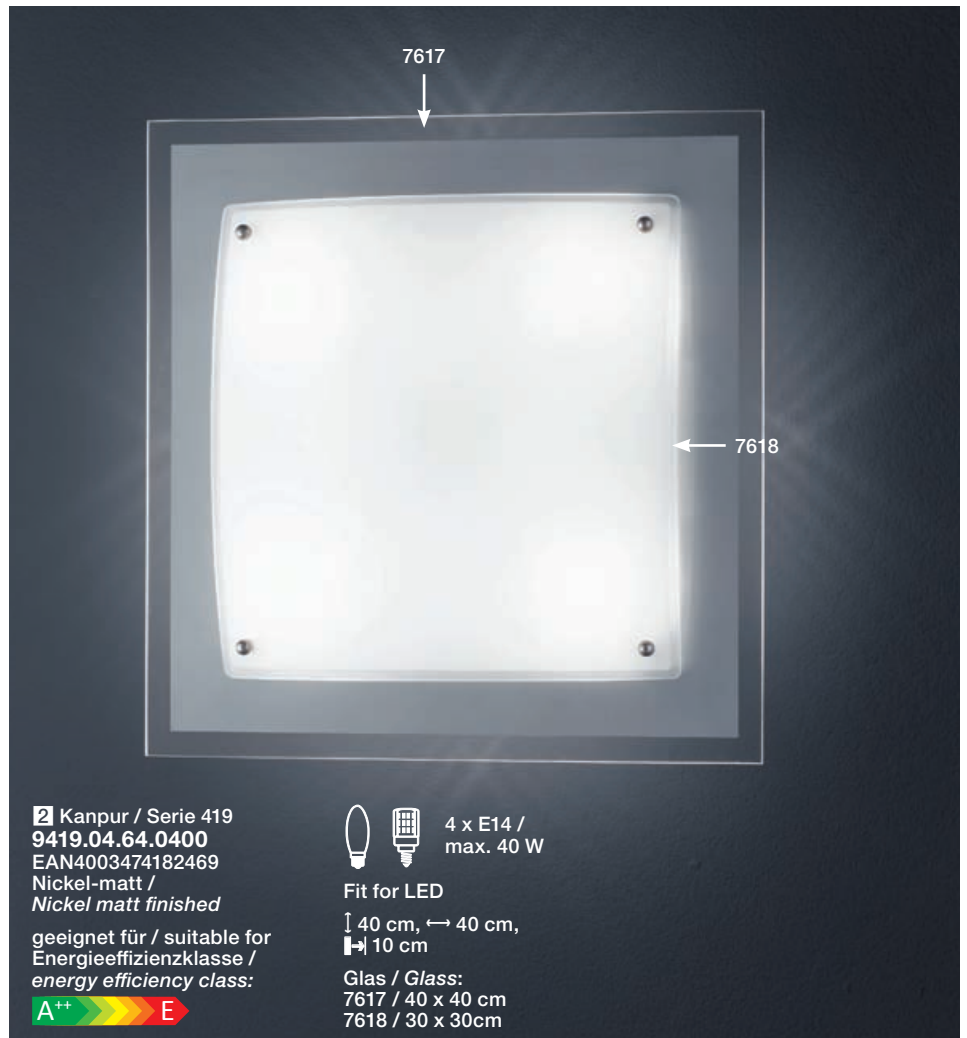
**2** Kanpur / Serie 419**9419.04.64.0400**

EAN4003474182469

Nickel-matt /

Nickel matt finished

geeignet für / suitable for
Energieeffizienzklasse /
energy efficiency class:4 x E14 /
max. 40 W

Fit for LED

↓ 40 cm, ↔ 40 cm,
↳ 10 cm

Glas / Glass:

7617 / 40 x 40 cm

7618 / 30 x 30 cm

Das richtige Glas macht das richtige Licht

...Perfect glass for perfect light

Raffinierter Effekt

Das leicht gebogene Glas gibt den Wand- /
Deckenleuchten einen Hauch von
3-Dimensionalität und versetzt dadurch das
Licht in noch mehr Spannung.

A sophisticated effect

Glass that's curved ever so slightly gives
these wall / ceiling light a hint of depth and
adds tension to the light.

**3** Figo / Serie 637**9637.01.64.0210**

EAN4003474168821

Nickel-matt /

Nickel matt finished

geeignet für / suitable for
Energieeffizienzklasse /
energy efficiency class:1 x E14 /
max. 60 W

Fit for LED

↓ 21 cm, ↔ 19 cm, ↳ 6,5 cm

Glas / Glass: 7041, 21 x 19 cm



1 Eddy / Serie 931
4931.02.64.0000
 EAN4003474158440
 Nickel-matt /
 Nickel matt finished

geeignet für / suitable for
 Energieeffizienzklasse /
 energy efficiency class:



Fit for LED

↓ 40 cm, ↔ 5 cm, ⇨ 8 cm

Glas: opal weiß-matt /
 Glass: opal white-matt
 Glas / Glass: 7369



2 Buddy / Serie 928
4928.01.64.0000
 EAN4003474156934
 Nickel-matt /
 Nickel matt finished

geeignet für / suitable for
 Energieeffizienzklasse /
 energy efficiency class:



Fit for LED

↓ 20 cm, ↔ 6 cm, ⇨ 10 cm

Glas: opal weiß /
 Glass: opal white
 Glas / Glass: 7363



3 Zibo / Serie 172
4172.02.06.0000
 EAN4003474206417
 Weiß / White

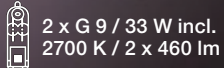

Energieeffizienzklasse /
 energy efficiency class:



Markenleuchtmittel /
 branded lamp incl.



↓ 32,5 cm, ↔ 16 cm,
 ⇨ 8 cm

Glas: opal weiß /
 Glass: opal white
 Glas / Glass: 7730



4 Zibo / Serie 172
4172.01.06.0000
 EAN4003474206424
 Weiß / White

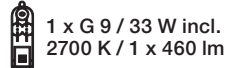

Energieeffizienzklasse /
 energy efficiency class:



Markenleuchtmittel /
 branded lamp incl.



↓ 20 cm, ↔ 16 cm,
 ⇨ 8 cm

Glas: opal weiß /
 Glass: opal white
 Glas / Glass: 7729

33W

460
 Lumen

Ein leuchtendes Beispiel für Wand-Kunst

...Shining example of creative wall art



33W
460 Lumen

1 Aqaba / Serie 451
4451.01.64.0000
EAN4003474207155
Nickel-matt / Nickel matt finished

1 x G9 / 33 W incl.
2700 K / 1 x 460 lm

Energieeffizienzklasse /
energy efficiency class:

D

Markenleuchtmittel /
branded lamp incl.



∓ 9 cm, Ø 8 cm, ⇄ 10 cm

Glas: opal weiß /
Glass: opal white
Glas / Glass: 7932



33W
460 Lumen

2 Aqaba / Serie 451
4451.01.64.0500
EAN4003474218724
Nickel-matt / Nickel matt finished

1 x G9 / 33 W incl.
2700 K / 1 x 460 lm

Energieeffizienzklasse /
energy efficiency class:

D

Markenleuchtmittel /
branded lamp incl.



∓ 9 cm, Ø 8 cm, ⇄ 10 cm

Glas: opal weiß /
Glass: opal white
Glas / Glass: 7932



3 Prince / Serie 432
4432.02.64.0000
EAN4003474168760
Nickel-matt /
Nickel matt finished

2 x G 9 / 33 W incl.
2700 K / 2 x 460 lm

Energieeffizienzklasse /
energy efficiency class:

D

Markenleuchtmittel /
branded lamp incl.



∓ 39 cm, ↔ 14 cm, ⇄ 9 cm

Glas: opal weiß / Glass: opal white
Glas / Glass: 7080

33W
460 Lumen

Weitere attraktive Wand- und Deckenleuchten finden Sie unter der Kategorie „Produktfamilien“ auf folgenden Seiten:

Additional attractive wall- and ceiling lamps please find in the category „product families“ on the following pages:



Vannes / Serie 625
9625.01.01.0000
Seite / Page 033



Vannes / Serie 625
4625.01.01.0000
Seite / Page 033



Comte / Serie 888
9888.01.64.0000
Seite / Page 035



Comte / Serie 888
4888.01.64.0000
Seite / Page 035



Colmar / Serie 234
4234.01.01.0000
Seite / Page 037



Logan / Serie 175
9175.09.01.0000
Seite / Page 039



Logan / Serie 175
9175.04.01.0000
Seite / Page 039



Louvre / Serie 825
9825.01.54.0000
Seite / Page 041



Louvre / Serie 825
4825.01.54.0000
Seite / Page 041



Avignon / Serie 275
9275.03.64.0000
Seite / Page 045



Avignon / Serie 275
9275.05.64.0000
Seite / Page 045



Luz / Serie 682
4682.01.01.0000
Seite / Page 049



Laurids / Serie 889
4889.01.64.0000
Seite / Page 056



Laurids / Serie 889
9889.04.64.0000
Seite / Page 057



Laurids / Serie 889
9889.01.64.0000
Seite / Page 057



Apart / Serie 366
4366.01.64.0000
Seite / Page 060



Mercur / Serie 313
4313.01.01.0000
Seite / Page 061



Orbit / Serie 946
4946.03.01.0000
Seite / Page 062

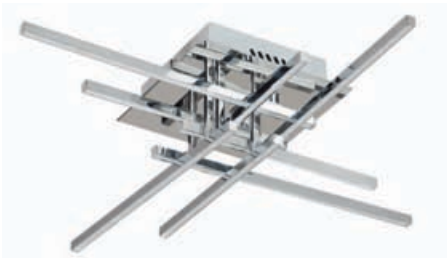

Orbit / Serie 946
9946.08.01.0000
Seite / Page 062



Orbit / Serie 946
4946.04.01.0000
Seite / Page 062



Strahlerserien

...Spotlight range

Bringen Licht auf den Punkt

Pures Design und eine effiziente Technologie lassen unsere Spots – im wahrsten Sinne des Wortes – erstrahlen! Optimal für punktuelle Lichtquellen im Wohnraum.

Focused lighting

Pure designs and efficient technology quite literally make our spotlights shine. Ideal if you need focused light sources in your home.

Antibes	206
Maar	210
Chloe	212
Texel	214
Vileta	216
Mauro	218
Cameron	220
Cara	222
Eve	226
Colo	228
Anissa	229
Quincy	230
Nice	234
Noa	235
Angola	236
Marco	239
Micky	240
Sleeve-Vetro	242
Nixon	243
Nini	244

Macht Räumlichkeiten lebendig

...Brings rooms to life



New!

New!



Antibes / Serie 792
9792.08.54.0500
EAN4003474289847
Nickel-matt / Chrom /
Nickel matt finished / Chrome



8 x LED / 4 W incl.
3000 K / 8 x 400 lm

Energieeffizienzklasse /
energy efficiency class:

A⁺

Markenleuchtmittel /
branded lamp incl.

↑ 34 cm, ↔ 34 cm, ↓ 15 cm

Glas / Glass: 1384, Ø 4,8 cm, ↑ 4,3 cm

getrennt schaltbar über Wandschalter
oder Fernbedienung /
separately switchable by wall switch
or remote control





2 Antibes / Serie 792
9792.06.54.0500
 EAN4003474289823
 Nickel-matt / Chrom /
 Nickel matt finished / Chrome



6 x LED / 4 W incl.
 3000 K / 6 x 400 lm

Energieeffizienzklasse /
 energy efficiency class:

A+

Markenleuchtmittel /
 branded lamp incl.

↔ 120 cm, ↗ 16 cm, ⊥ 15 cm

Glas / Glass: 1384, Ø 4,8 cm, ↑ 4,3 cm
 getrennt schaltbar über Wandschalter
 oder Fernbedienung /
 separately switchable by wall switch
 or remote control



4W

400
 Lumen



3 Antibes / Serie 792
7792.06.54.0500
 EAN4003474289816
 Nickel-matt / Chrom /
 Nickel matt finished / Chrome



6 x LED / 4 W incl.
 3000 K / 6 x 400 lm

Energieeffizienzklasse /
 energy efficiency class:

A+

Markenleuchtmittel /
 branded lamp incl.

↔ 60 cm, ↗ 8 cm, ⊥ 17,5 cm

Glas / Glass: 1384, Ø 4,8 cm, ↑ 4,3 cm

getrennt schaltbar über Wandschalter
 oder Fernbedienung /
 separately switchable by wall switch
 or remote control





1 Antibes / Serie 792
9792.06.01.0000
 EAN4003474289342
 Chrom / Chrome



6 x LED / 4 W incl.
 3000 K / 6 x 400 lm

Energieeffizienzklasse /
 energy efficiency class:

A⁺

Markenleuchtmittel /
 branded lamp incl.

↔ 120 cm, ↗ 16 cm, ↓ 15 cm

Glas / Glass: 1386
 Ø 4,8 cm, ↓ 4,3 cm

getrennt schaltbar über Wandschalter oder
 Fernbedienung /
 separately switchable by wall switch
 or remote control



LED Light
 by **WOFI**

2 Antibes / Serie 792
9792.08.01.0000
 EAN4003474289397
 Chrom / Chrome



8 x LED / 4 W incl.
 3000 K / 8 x 400 lm

Energieeffizienzklasse /
 energy efficiency class:

A⁺

Markenleuchtmittel /
 branded lamp incl.

↓ 34 cm, ↔ 34 cm, ↓ 15 cm

Glas / Glass: 1386
 Ø 4,8 cm, ↓ 4,3 cm

getrennt schaltbar über Wand-
 schalter oder Fernbedienung /
 separately switchable by wall
 switch or remote control



4W
400
Lumen



Neu!
Neu!



3 Antibes / Serie 792
9792.06.01.0300
EAN4003474289373
Chrom / Chrome



6 x LED / 4 W incl.
3000 K / 6 x 400 lm

Energieeffizienzklasse /
energy efficiency class:



Markenleuchtmittel /
branded lamp incl.

Ø 34 cm, ↓ 15 cm

Glas / Glass: 1386
Ø 4,8 cm, ↓ 4,3 cm

getrennt schaltbar über Wand-
schalter oder Fernbedienung /
separately switchable by wall
switch or remote control



4 Antibes / Serie 792
9792.10.01.0000
EAN4003474289410
Chrom / Chrome



10 x LED / 4 W incl.
3000 K / 10 x 400 lm

Energieeffizienzklasse /
energy efficiency class:



Markenleuchtmittel /
branded lamp incl.

↔ 200 cm, ↗ 16 cm, ↓ 17,5 cm

Glas / Glass: 1386
Ø 4,8 cm, ↓ 4,3 cm

getrennt schaltbar über Wand-
schalter oder Fernbedienung /
separately switchable by wall
switch or remote control





1 Maar / Serie 806
7806.02.01.0000
 EAN4003474034881
 Chrom / Chrome



2 x LED / 5 W incl.
 3000 K / 2 x 400 lm

Energieeffizienzklasse /
 energy efficiency class:



Markenleuchtmittel /
 branded lamp incl.

↑ 7,5 cm, ↔ 32 cm, ↓ 15 cm



2 Maar / Serie 806
9806.04.01.0000
 EAN4003474040240
 Chrom / Chrome



4 x LED / 5 W incl.
 3000 K / 4 x 400 lm

Energieeffizienzklasse /
 energy efficiency class:



Markenleuchtmittel /
 branded lamp incl.

↑ 25 cm, ↔ 25 cm, ↓ 15 cm

Licht und Wasser in perfekter Kombination

...Light and water in perfect combination



3 Maar / Serie 806
7806.03.01.0000
 EAN4003474269894
 Chrom / Chrome



3 x LED / 5 W incl.
 3000 K / 3 x 400 lm

Energieeffizienzklasse /
 energy efficiency class:



Markenleuchtmittel /
 branded lamp incl.

↑ 7,5 cm, ↔ 45,5 cm, ↓ 15 cm

LED Light
by **WOFI**

4 Maar / Serie 806
4806.01.01.0000
EAN4003474034843
Chrom / Chrome



1 x LED / 5 W incl.
3000 K / 1 x 400 lm

Energieeffizienzklasse /
energy efficiency class:

A+

Markenleuchtmittel /
branded lamp incl.

⌈ 10 cm, ↔ 10 cm, ▬ 15 cm



1 Chloe / Serie 195
9195.06.01.0500
EAN4003474289236
Chrom / Chrome



6 x LED / 5 W incl.
3000 K / 6 x 300 lm

Energieeffizienzklasse /
energy efficiency class:

A

Markenleuchtmittel /
branded lamp incl.

↔ 180 cm, ⊥ 15 cm

LED Light
by WOFI



*Viel Licht auf
kleinem Raum*
...lot of light in a little space

2 Chloe / Serie 195
7195.02.01.0000
EAN4003474289212
Chrom / Chrome



2 x LED / 5 W incl.
3000 K / 2 x 300 lm

Energieeffizienzklasse /
energy efficiency class:

A

Markenleuchtmittel /
branded lamp incl.

↔ 36,5 cm, ⊥ 10 cm



3 Chloe / Serie 195
9195.04.01.0500
EAN4003474289229
Chrom / Chrome



4 x LED / 5 W incl.
3000 K / 4 x 300 lm

Energieeffizienzklasse /
energy efficiency class:

A

Markenleuchtmittel /
branded lamp incl.

↔ 92 cm, ⊥ 15 cm

New!
New!



4 Chloe / Serie 195
4195.01.01.0000
EAN4003474289205
Chrom / Chrome

Energieeffizienzklasse /
energy efficiency class:

A

Markenleuchtmittel /
branded lamp incl.



1 x LED / 5 W incl.
3000 K / 1 x 300 lm

Ø 9 cm → 15



5 Chloe / Serie 195
9195.06.01.0000
EAN4003474281599
Chrom / Chrome



6 x LED / 5 W incl.
3000 K / 6 x 300 lm

Energieeffizienzklasse /
energy efficiency class:

A

Markenleuchtmittel /
branded lamp incl.

Ø 35 cm, ↓ 10 cm



6 Chloe / Serie 195
9195.04.01.0000
EAN4003474283746
Chrom / Chrome

Energieeffizienzklasse /
energy efficiency class:

A

Markenleuchtmittel /
branded lamp incl.



4 x LED / 5 W incl.
3000 K / 4 x 300 lm

Ø 30 cm, ↓ 10 cm

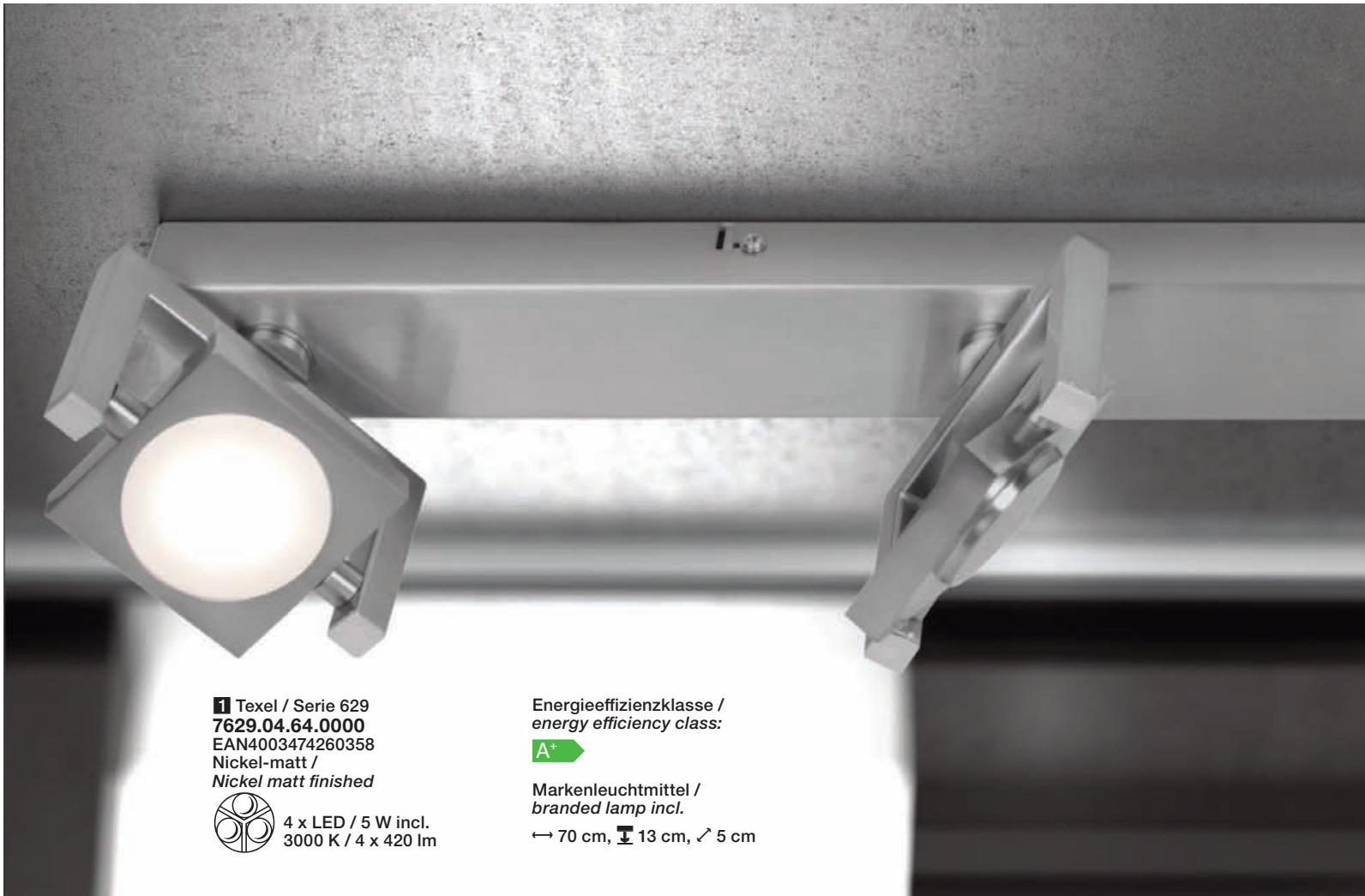

1 Texel / Serie 629
7629.04.64.0000
EAN4003474260358
Nickel-matt /
Nickel matt finished



4 x LED / 5 W incl.
3000 K / 4 x 420 lm

Energieeffizienzklasse /
energy efficiency class:



Markenleuchtmittel /
branded lamp incl.

↔ 70 cm, ⊥ 13 cm, ↗ 5 cm

LED Light
by **WOFI**

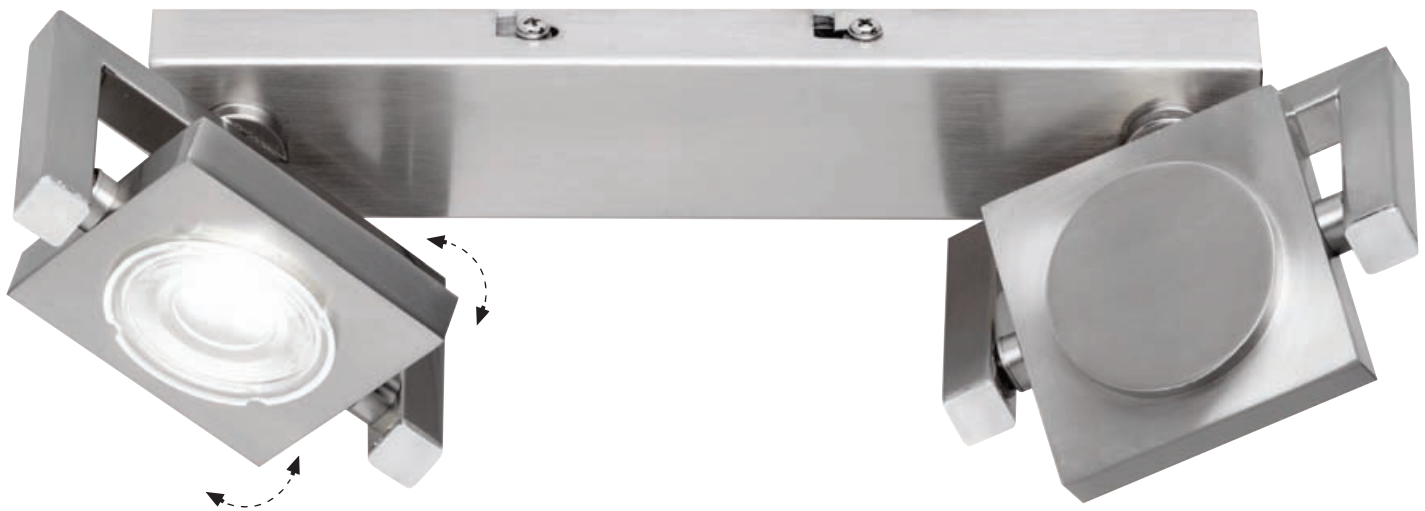

2 Texel / Serie 629
7629.02.64.0000
EAN4003474260341
Nickel-matt /
Nickel matt finished



2 x LED / 5 W incl.
3000 K / 2 x 420 lm

Energieeffizienzklasse /
energy efficiency class:



Markenleuchtmittel /
branded lamp incl.

↔ 24 cm, ⊥ 13 cm, ↗ 6,5 cm

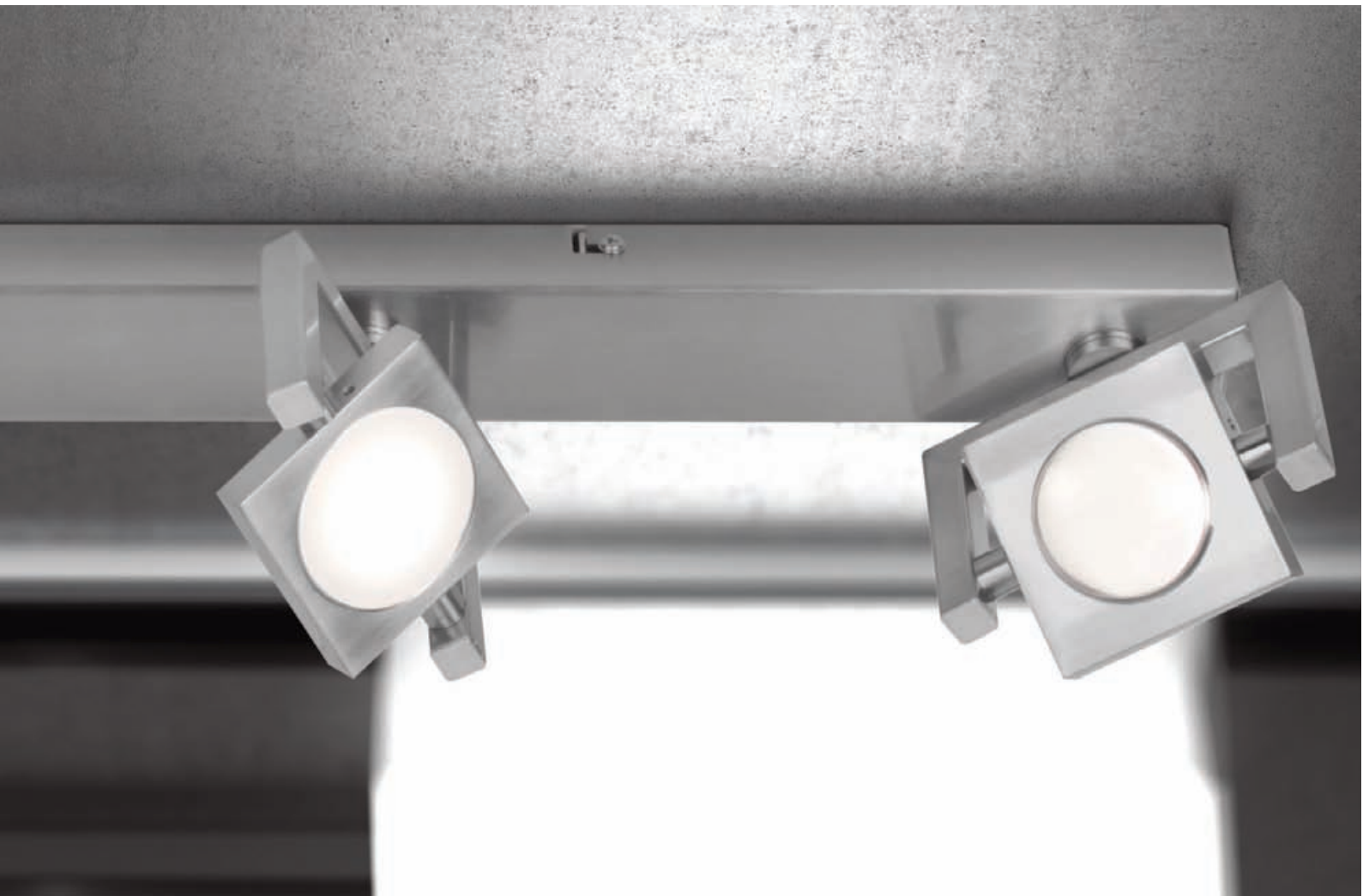

Lichtkonzepte mit System

...Lighting concepts with a system

3 Texel / Serie 629
4629.01.64.0000
 EAN4003474260334
 Nickel-matt /
 Nickel matt finished

 1 x LED / 5 W incl.
 3000 K / 1 x 420 lm

Energieeffizienzklasse /
 energy efficiency class:

A⁺

Markenleuchtmittel /
 branded lamp incl.

l 10 cm, ↔ 6 cm, H 13 cm



5W

420
 Lumen



1 Vileta / Serie 254
9254.06.64.0000
 EAN4003474283753
 Nickel-matt /
 Nickel matt finished



6 x LED / 4,5 W incl.
 3000 K / 6 x 360 lm

Energieeffizienzklasse /
 energy efficiency class:

A+

Markenleuchtmittel /
 branded lamp incl.

↔ 150 cm, ⊥ 18,5 cm

Glas / Glass: 3033

↔ 8,6 cm, ⊥ 6,8 cm

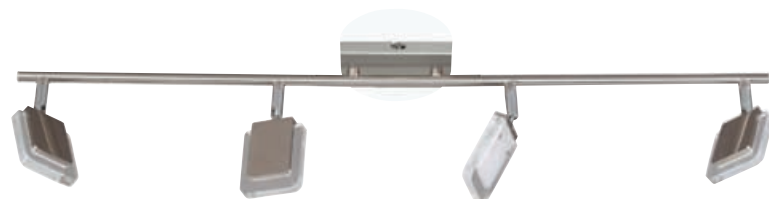

2 Vileta / Serie 254
9254.04.64.0000
 EAN4003474281926
 Nickel-matt /
 Nickel matt finished



4 x LED / 4,5 W incl.
 3000 K / 4 x 360 lm

Energieeffizienzklasse /
 energy efficiency class:

A+

Markenleuchtmittel /
 branded lamp incl.

↔ 80 cm, ⊥ 19 cm

Glas / Glass: 3033

↔ 8,6 cm, ⊥ 6,8 cm



3 Vileta / Serie 254
4254.01.64.0500
 EAN4003474281933
 Nickel-matt /
 Nickel matt finished



1 x LED / 4,5 W incl.
 3000 K / 1 x 360 lm

Markenleuchtmittel /
 branded lamp incl.

⊥ 8,5 cm, ↔ 8,5 cm, ⇄ 31 cm

Glas / Glass: 3033,

↔ 8,6 cm, ⊥ 6,8 cm



Energieeffizienzklasse /
 energy efficiency class:

A+

Neu!
Neu!

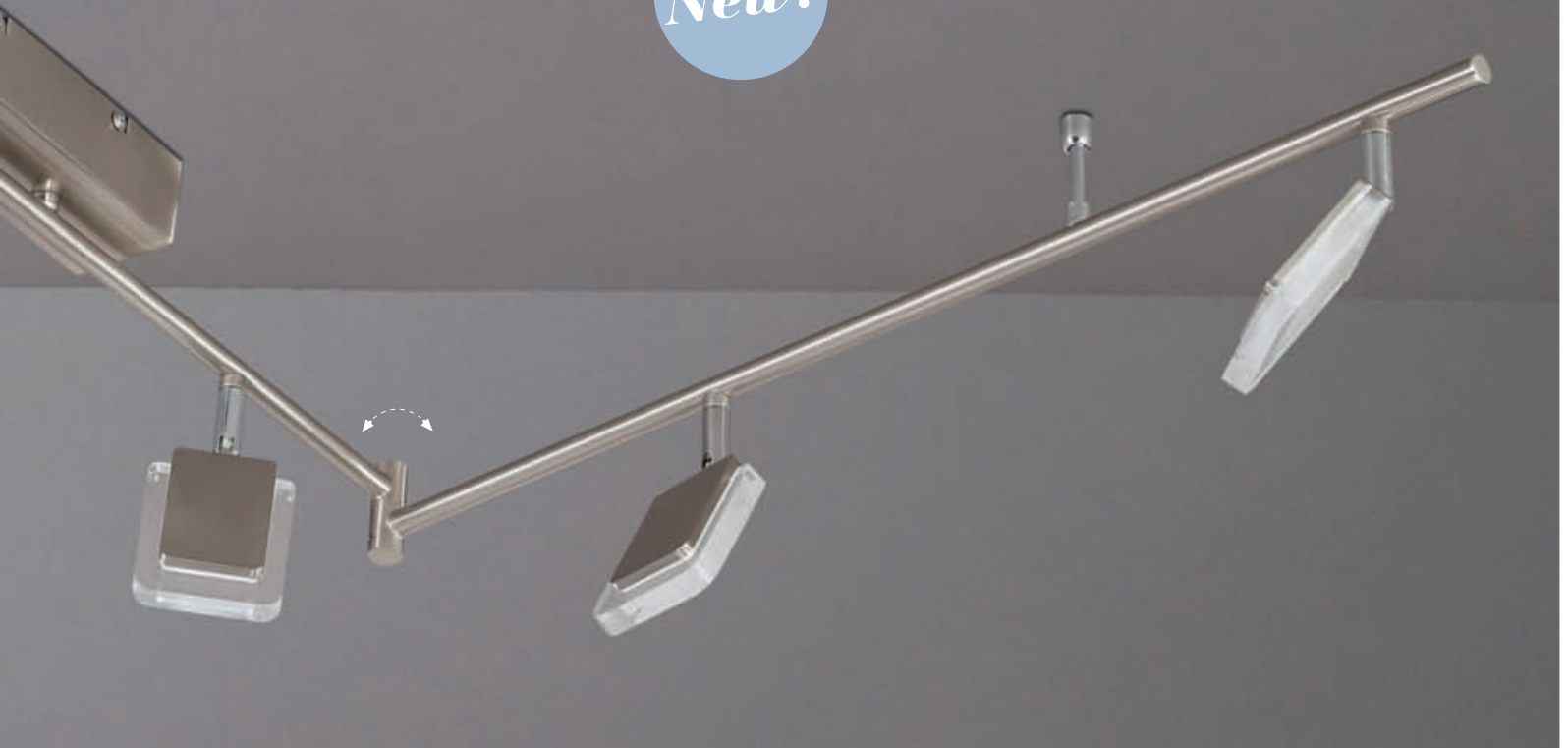

4 Vileta / Serie 254
7254.02.64.0000
EAN4003474128566
Nickel-matt /
Nickel matt finished



2 x LED / 4,5 W incl.
3000 K / 2 x 360 lm

Energieeffizienzklasse /
energy efficiency class:



Markenleuchtmittel /
branded lamp incl.

↔ 35 cm, ↓ 19 cm

Glas / Glass: 3033
↔ 8,6 cm, ↓ 6,8 cm

5 Vileta / Serie 254
4254.01.64.0000
EAN4003474132662
Nickel-matt /
Nickel matt finished



1 x LED / 4,5 W incl.
3000 K / 1 x 360 lm

Markenleuchtmittel /
branded lamp incl.

↑ 8,5 cm, ↔ 8,5 cm, ↓ 16,5 cm

Glas / Glass: 3033
↔ 8,6 cm, ↓ 6,8 cm

Energieeffizienzklasse /
energy efficiency class:



LED Light
by WOFI



1 Mauro / Serie 301
3301.01.64.0000
EAN4003474241715
Nickel-matt /
Nickel matt finished



Energieeffizienzklasse /
energy efficiency class:



Markenleuchtmittel /
branded lamp incl.

↑ 140 cm, ⇨ 26 cm

Glas: weiß lackiert mit Klarrand /
Glass: white laquered with
clear border
Glas / Glass: 6097, Ø 7,4 cm



5W
420
Lumen



2 Mauro / Serie 301
7301.02.64.0000
EAN4003474235660
Nickel-matt / Nickel matt finished



Energieeffizienzklasse /
energy efficiency class:



Markenleuchtmittel /
branded lamp incl.

↔ 40 cm, ⇨ 22 cm

Glas: weiß lackiert mit Klarrand /
Glass: white laquered with
clear border
Glas / Glass: 6097, Ø 7,4 cm



3 Mauro / Serie 301
8301.01.64.0000
EAN4003474239644
Nickel-matt /
Nickel matt finished



Energieeffizienzklasse /
energy efficiency class:



Markenleuchtmittel /
branded lamp incl.

↑ 44 cm, ⇨ 22 cm

Glas: weiß lackiert
mit Klarrand /
Glass: white laquered
with clear border
6097, Ø 7,4 cm



Moderne Form trifft lackiertes Glas

...Modern design meets lacquered glass

Durch ihre unaufdringliche, schlichte Form verleiht die Serie MAURO jedem Raum eine charmante Note.

Series MAURO – its discreet and homely style gives a charming ambiance to your room.



4 Mauro / Serie 301
4301.01.64.0000
 EAN4003474235516
 Nickel-matt /
 Nickel matt finished
 1 x LED / 5 W incl.
 3000 K / 1 x 420 lm

Energieeffizienzklasse /
 energy efficiency class:

A+

Markenleuchtmittel /
 branded lamp incl.

↔ 18 cm, ↕ 7 cm, ⇨ 20 cm
 Glas: weiß lackiert
 mit Klarrand /
 Glass: white laquered
 with clear border
 Glas / Glass: 6097, Ø 7,4 cm



5 Mauro / Serie 301
9301.06.64.0000
 EAN4003474235707
 Nickel-matt /
 Nickel matt finished
 6 x LED / 5 W incl.
 3000 K / 6 x 420 lm

Energieeffizienzklasse /
 energy efficiency class:

A+

Markenleuchtmittel /
 branded lamp incl.

↔ 240 cm, ⇩ 22 cm

Glas: weiß lackiert
 mit Klarrand /
 Glass: white laquered
 with clear border
 Glas / Glass:
 6097, ↔ 7,4 cm

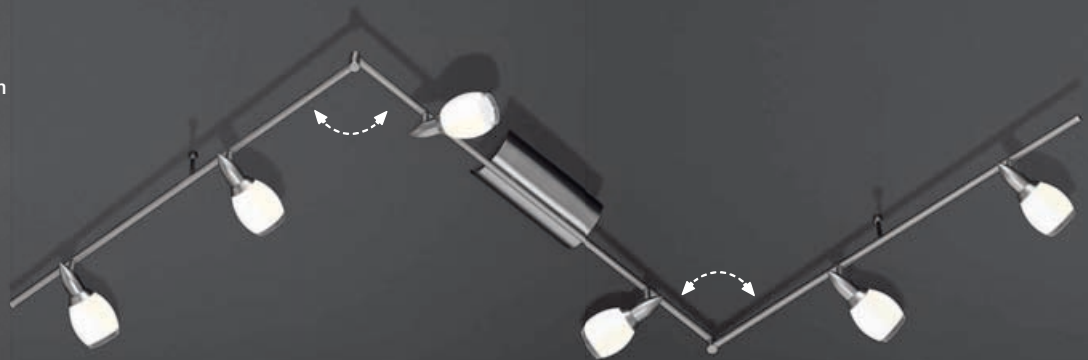

6 Mauro / Serie 301
7301.04.64.0000
 EAN4003474235684
 Nickel-matt /
 Nickel matt finished
 4 x LED / 5 W incl.
 3000 K / 4 x 420 lm

Energieeffizienzklasse /
 energy efficiency class:

A+

Markenleuchtmittel /
 branded lamp incl.

↔ 80 cm, ⇩ 22 cm

Glas: weiß lackiert
 mit Klarrand /
 Glass: white laquered
 with clear border
 Glas / Glass:
 6097, Ø 7,4 cm



5W

420
 Lumen

1 Cameron / Serie 796

4796.01.32.0000

EAN4003474282466

Messing-matt /

Brass matt finished



1 x LED / 5 W incl.
2700 K / 1 x 430 lm

Energieeffizienzklasse /
energy efficiency class:

A⁺

Markenleuchtmittel /
Branded lamp incl.

┆ 13 cm, ↔ 7,5 cm, ┆ 11 cm



*Das ist die
perfekte Welle*
...It's a perfect wave



5W
430
Lumen

2 Cameron / Serie 796

7796.02.32.0000

EAN4003474282480

Messing-matt /

Brass matt finished



2 x LED / 5 W incl.
2700 K / 2 x 430 lm

Energieeffizienzklasse /
energy efficiency class:

A⁺

Markenleuchtmittel /
Branded lamp incl.

↔ 35,5 cm, ┆ 14,5 cm



LED Light
by WOFI

3 Cameron / Serie 796

9796.04.32.0000

EAN4003474282503

Messing-matt /

Brass matt finished



4 x LED / 5 W incl.
2700 K / 4 x 430 lm

Energieeffizienzklasse /
energy efficiency class:

A⁺

Markenleuchtmittel /
Branded lamp incl.

↔ 70 cm, ┆ 15 cm,
↙ 39 cm

4 Cameron / Serie 796

9796.06.32.0000

EAN4003474282527

Messing-matt /

Brass matt finished



6 x LED / 5 W incl.
2700 K / 6 x 430 lm

Energieeffizienzklasse /
energy efficiency class:

A⁺

Markenleuchtmittel /
Branded lamp incl.

↔ 180 cm, ┆ 16,7 cm

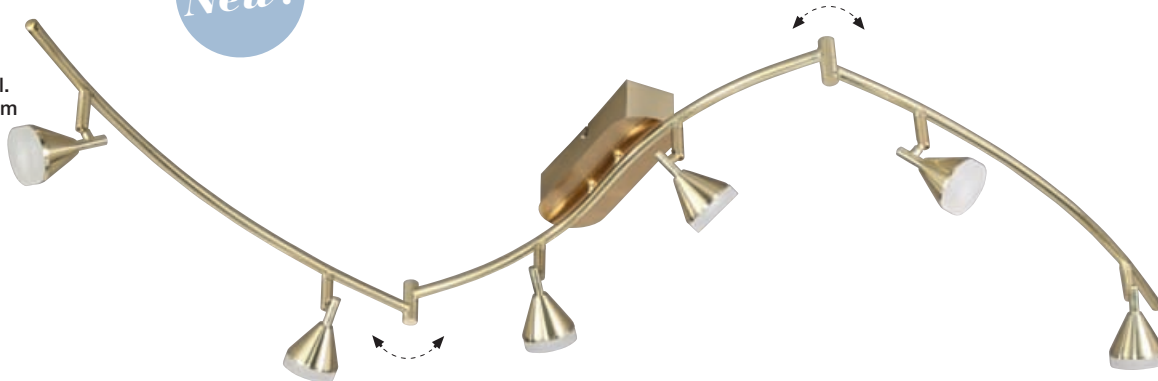



5 Cameron / Serie 796
7796.02.64.0000
 EAN4003474282497
 Nickel-matt /
 Nickel matt finished



2 x LED / 5 W incl.
 3000 K / 2 x 430 lm

Energieeffizienzklasse /
 energy efficiency class:

A⁺

Markenleuchtmittel /
 Branded lamp incl.

↔ 35,5 cm, ⊥ 14,5 cm

LED Light
 by **WOFI**



6 Cameron / Serie 796
4796.01.64.0000
 EAN4003474282473
 Nickel-matt /
 Nickel matt finished



1 x LED / 5 W incl.
 3000 K / 1 x 430 lm

Energieeffizienzklasse /
 energy efficiency class:

A⁺

Markenleuchtmittel /
 Branded lamp incl.

⌈ 13 cm, ↔ 7,5 cm, ⊥ 11 cm

Neu!

Neu!



7 Cameron / Serie 796
9796.04.64.0000
 EAN4003474282510
 Nickel-matt /
 Nickel matt finished



4 x LED / 5 W incl.
 3000 K / 4 x 430 lm

Energieeffizienzklasse /
 energy efficiency class:

A⁺

Markenleuchtmittel /
 Branded lamp incl.

↔ 70 cm, ⊥ 15 cm,
 ↗ 39 cm

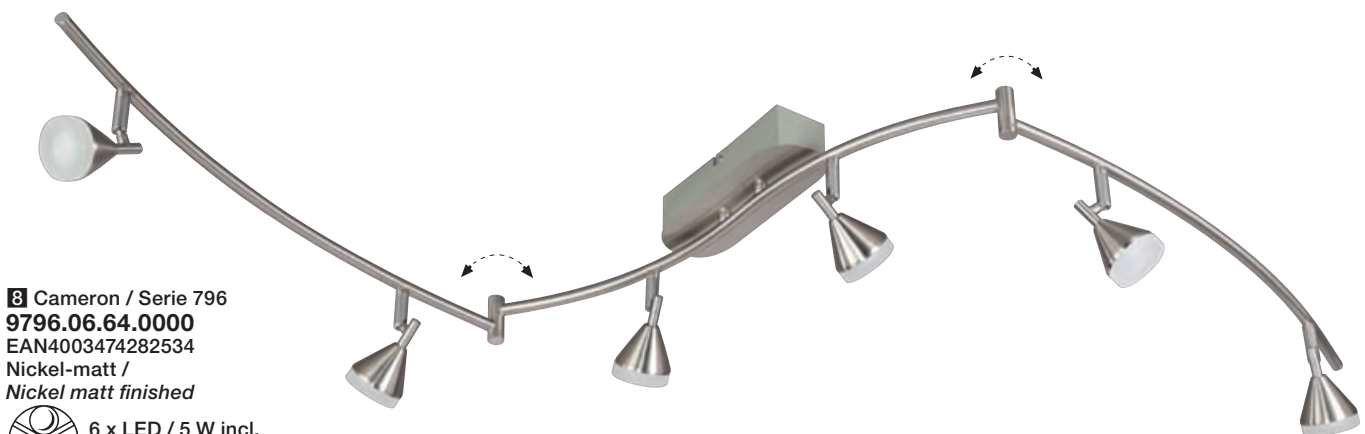

8 Cameron / Serie 796
9796.06.64.0000
 EAN4003474282534
 Nickel-matt /
 Nickel matt finished



6 x LED / 5 W incl.
 3000 K / 6 x 430 lm

Markenleuchtmittel /
 Branded lamp incl.

Energieeffizienzklasse /
 energy efficiency class:

A⁺

↔ 180 cm, ⊥ 16,7 cm



1 Cara / Serie 535
7535.04.64.0000
 EAN4003474270708
 Nickel-matt / Nickel matt finished

 4 x LED / 5 W incl.
 3000 K / 4 x 450 lm

Energieeffizienzklasse /
 energy efficiency class:

A+

Markenleuchtmittel / branded lamp incl.

↔ 88 cm, ↓ 19,5 cm

Glas: opal weiß satiniert / Innenschliff
 Glass: opal white satined / cutline inside
 Glas / Glass: 6267, Ø 9 cm, ↓ 6,55 cm

Dimmbar mittels geeignetem Wanddimmer /
 dimmable by suitable wall dimmer



2 Cara / Serie 535
4535.01.64.0000
 EAN4003474270678
 Nickel-matt /
 Nickel matt finished

 1 x LED / 5 W incl.
 3000 K / 1 x 450 lm

Energieeffizienzklasse /
 energy efficiency class:

A+

Markenleuchtmittel /
 branded lamp incl.

↓ 17 cm, → 15 cm

Glas: opal weiß satiniert /
 Innenschliff
 Glass: opal white satined /
 cutline inside
 Glas / Glass: 6267,
 Ø 9 cm, ↓ 6,55 cm



5W

450
 Lumen



3 Cara / Serie 535
7535.02.64.0000
 EAN4003474270685
 Nickel-matt /
 Nickel matt finished

 2 x LED / 5 W incl.
 3000 K / 2 x 450 lm

Energieeffizienzklasse /
 energy efficiency class:

A+

Markenleuchtmittel / branded lamp incl.

↔ 40 cm, ↓ 18 cm

Glas: opal weiß satiniert / Innenschliff
 Glass: opal white satined / cutline inside
 Glas / Glass: 6267, Ø 9 cm, ↓ 6,55 cm

Dimmbar mittels geeignetem
 Wanddimmer /
 dimmable by suitable wall dimmer





**Kein Widerspruch mehr:
Licht an, Spot an**
...No opposition: Lights on, Spots on

LED Light
by **WOFI**



4 Cara / Serie 535
9535.06.64.0000
EAN4003474270715
Nickel-matt /
Nickel matt finished

6 x LED / 5 W incl.
3000 K / 6 x 450 lm

Energieeffizienzklasse /
energy efficiency class:



Markenleuchtmittel / branded lamp incl.

↔ 168 cm, ↓ 20,5 cm

Glas: opal weiß satiniert / Innenschliff
Glass: opal white satined / cutline inside
Glas / Glass: 6267, Ø 9 cm, ↓ 6,55 cm

Dimmbar mittels geeignetem Wanddimmer /
dimmable by suitable wall dimmer





1 Cara / Serie 535
7535.04.32.0000
 EAN4003474273594
 Messing-matt / Brass matt finished



4 x LED / 5 W incl.
 3000 K / 4 x 450 lm

Energieeffizienzklasse /
 energy efficiency class:

A+

Markenleuchtmittel / branded lamp incl.

↔ 88 cm, ↓ 19,5 cm

Glas: opal weiß satiniert / Innenschliff
 Glass: opal white satined / cutline inside
 Glas / Glass: 6267, Ø 9 cm, ↓ 6,55 cm

Dimmbar mittels geeignetem Wanddimmer /
 dimmable by suitable wall dimmer



2 Cara / Serie 535
4535.01.32.0000
 EAN4003474273563
 Messing-matt /
 Brass matt finished



1 x LED / 5 W incl.
 3000 K / 1 x 450 lm

Energieeffizienzklasse /
 energy efficiency class:

A+

Markenleuchtmittel /
 branded lamp incl.

↑ 17 cm, → 15 cm

Glas: opal weiß satiniert /
 Innenschliff
 Glass: opal white satined /
 cutline inside
 Glas / Glass: 6267,
 Ø 9 cm, ↓ 6,55 cm



5W

450
 Lumen



3 Cara / Serie 535
7535.02.32.0000
 EAN4003474273570
 Messing-matt /
 Brass matt finished



2 x LED / 5 W incl.
 3000 K / 2 x 450 lm

Energieeffizienzklasse /
 energy efficiency class:

A+

Markenleuchtmittel / branded lamp incl.

↔ 40 cm, ↓ 18 cm

Glas: opal weiß satiniert / Innenschliff
 Glass: opal white satined / cutline inside
 Glas / Glass: 6267, Ø 9 cm, ↓ 6,55 cm

Dimmbar mittels geeignetem
 Wanddimmer /
 dimmable by suitable wall dimmer





LED Light
by **WOFI**

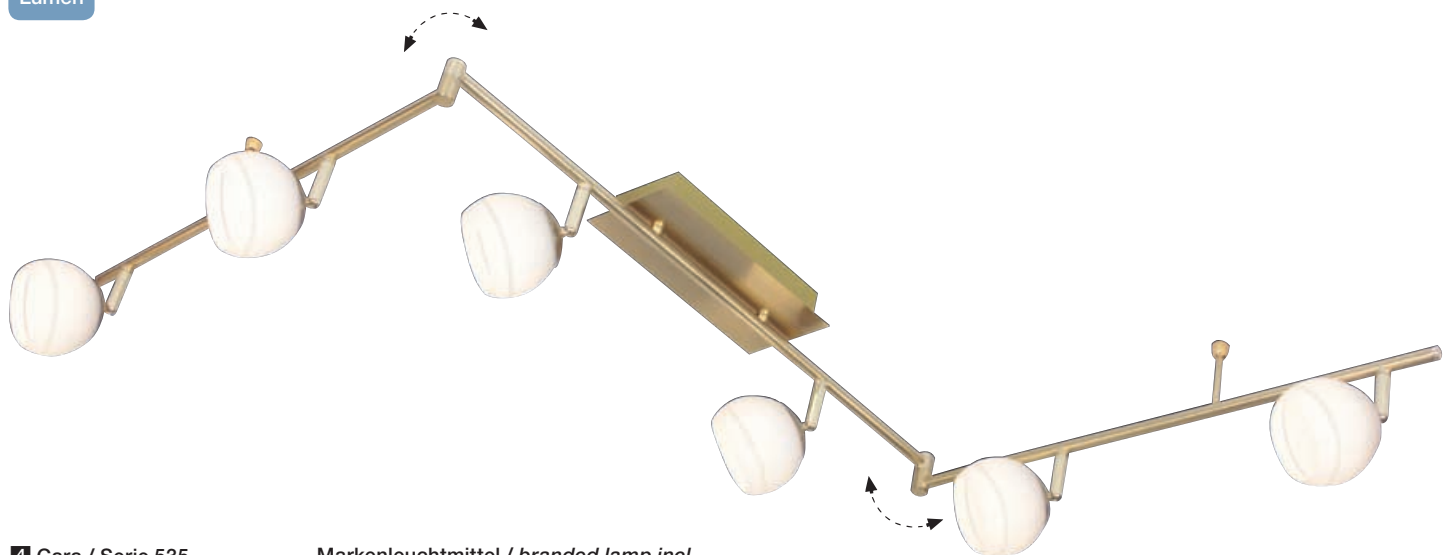

4 Cara / Serie 535
9535.06.32.0000
EAN4003474273617
Messing-matt /
Brass matt finished

 6 x LED / 5 W incl.
3000 K / 6 x 450 lm

Energieeffizienzklasse /
energy efficiency class:



Markenleuchtmittel / *branded lamp incl.*

↔ 168 cm, ↓ 20,5 cm

Glas: opal weiß satiniert / Innenschliff
Glass: *opal white satined / cutline inside*
Glas / Glass: 6267, Ø 9 cm, ↓ 6,55 cm

Dimmbar mittels geeignetem Wanddimmer /
dimmable by suitable wall dimmer



LED Light
by WOFI®



1 Eve / Serie 361
9361.06.09.0000
EAN4003474281414
Antik braun / Antique brown



6 x LED / 5 W incl.
3000 K / 6 x 400 lm

Energieeffizienzklasse /
energy efficiency class:

A+

Markenleuchtmittel /
branded lamp incl.

↔ 157 cm, ⊥ 21 cm

Glas / Glass: 6622, Ø 7 cm

Neu!

Neu!



2 Eve / Serie 361
4361.01.09.0000
EAN4003474281346
Antik braun / Antique brown



1 x LED / 5 W incl.
3000 K / 1 x 400 lm

Markenleuchtmittel /
branded lamp incl.

Ø 8 cm, ⊥ 19 cm

Glas / Glass: 6622
Ø 7 cm



Energieeffizienzklasse /
energy efficiency class:

A+



Energieeffizienzklasse /
energy efficiency class:

A+

Markenleuchtmittel /
branded lamp incl.

↔ 40 cm, ⊥ 20 cm

Glas / Glass: 6622
Ø 7 cm

3 Eve / Serie 361
7361.02.09.0000
EAN4003474281360
Antik braun / Antique brown



2 x LED / 5 W incl.
3000 K / 2 x 400 lm

Klassische Lichtgestaltung

...Classical lighting



4 Eve / Serie 361
9361.04.09.0000
EAN4003474281391
Antik braun / Antique brown



4 x LED / 5 W incl.
3000 K / 4 x 400 lm

Energieeffizienzklasse /
energy efficiency class:

A+

Markenleuchtmittel /
branded lamp incl.

↔ 72 cm, ⊥ 20 cm

Glas / Glass: 6622
Ø 7 cm

LED Light
by **WOFI**



5 Eve / Serie 361
9361.04.64.0000
EAN4003474281407
Nickel-matt /
Nickel matt finished

 4 x LED / 5 W incl.
3000 K / 4 x 400 lm

Energieeffizienzklasse /
energy efficiency class:
A+

Markenleuchtmittel /
branded lamp incl.

↔ 72 cm, ⊥ 20 cm
Glas / Glass: 6622, Ø 7 cm



6 Eve / Serie 361
4361.01.64.0000
EAN4003474281353
Nickel-matt /
Nickel matt finished

 1 x LED / 5 W incl.
3000 K / 1 x 400 lm

Energieeffizienzklasse /
energy efficiency class:
A+

Markenleuchtmittel /
branded lamp incl.

Ø 8 cm, ⊥ 19 cm
Glas / Glass: 6622, Ø 7 cm





7 Eve / Serie 361
7361.02.64.0000
EAN4003474281377
Nickel-matt /
Nickel matt finished

 2 x LED / 5 W incl.
3000 K / 2 x 400 lm

Energieeffizienzklasse /
energy efficiency class:
A+

Markenleuchtmittel /
branded lamp incl.

↔ 40 cm, ⊥ 20 cm
Glas / Glass: 6622, Ø 7 cm

5W
400
Lumen

Neu!
Neu!

Schlichte Eleganz ist
immer up to date

Simple elegance is
always up to date



8 Eve / Serie 361
9361.06.64.0000
EAN4003474281421
Nickel-matt /
Nickel matt finished

 6 x LED / 5 W incl.
3000 K / 6 x 400 lm

Energieeffizienzklasse /
energy efficiency class:
A+

Markenleuchtmittel /
branded lamp incl.

↔ 157 cm, ⊥ 21 cm
Glas / Glass: 6622, Ø 7 cm



1 Colo / Serie 377
9377.06.64.0000
 EAN4003474273365
 Nickel-matt /
 Nickel matt finished

6 x LED / 5 W incl.
 3000 K / 6 x 400 lm

Energieeffizienzklasse /
 energy efficiency class:
A+

Markenleuchtmittel /
 branded lamp incl.

↔ 188 cm cm, ⊥ 23 cm

Glas: weiß gewischt /
 Glass: white wipe technique
 Glas / Glass: 6227
 Ø 6 cm, ↔ 9 cm

LED Light
 by **WOFI**



2 Colo / Serie 377
9377.04.64.0000
 EAN4003474273341
 Nickel-matt /
 Nickel matt finished

4 x LED / 5 W incl.
 3000 K / 4 x 400 lm

Energieeffizienzklasse /
 energy efficiency class:
A+

Markenleuchtmittel /
 branded lamp incl.

↔ 93 cm, ⊥ 18,5 cm

Glas: weiß gewischt /
 Glass: white wipe technique
 Glas / Glass: 6227
 Ø 6 cm, ↔ 9 cm

3 Colo / Serie 377
7377.02.64.0000
 EAN4003474273334
 Nickel-matt /
 Nickel matt finished

2 x LED / 5 W incl.
 3000 K / 2 x 400 lm

Energieeffizienzklasse /
 energy efficiency class:
A+

Markenleuchtmittel /
 branded lamp incl.

↔ 44 cm, ⊥ 19 cm

Glas: weiß gewischt /
 Glass: white wipe technique
 Glas / Glass: 6227

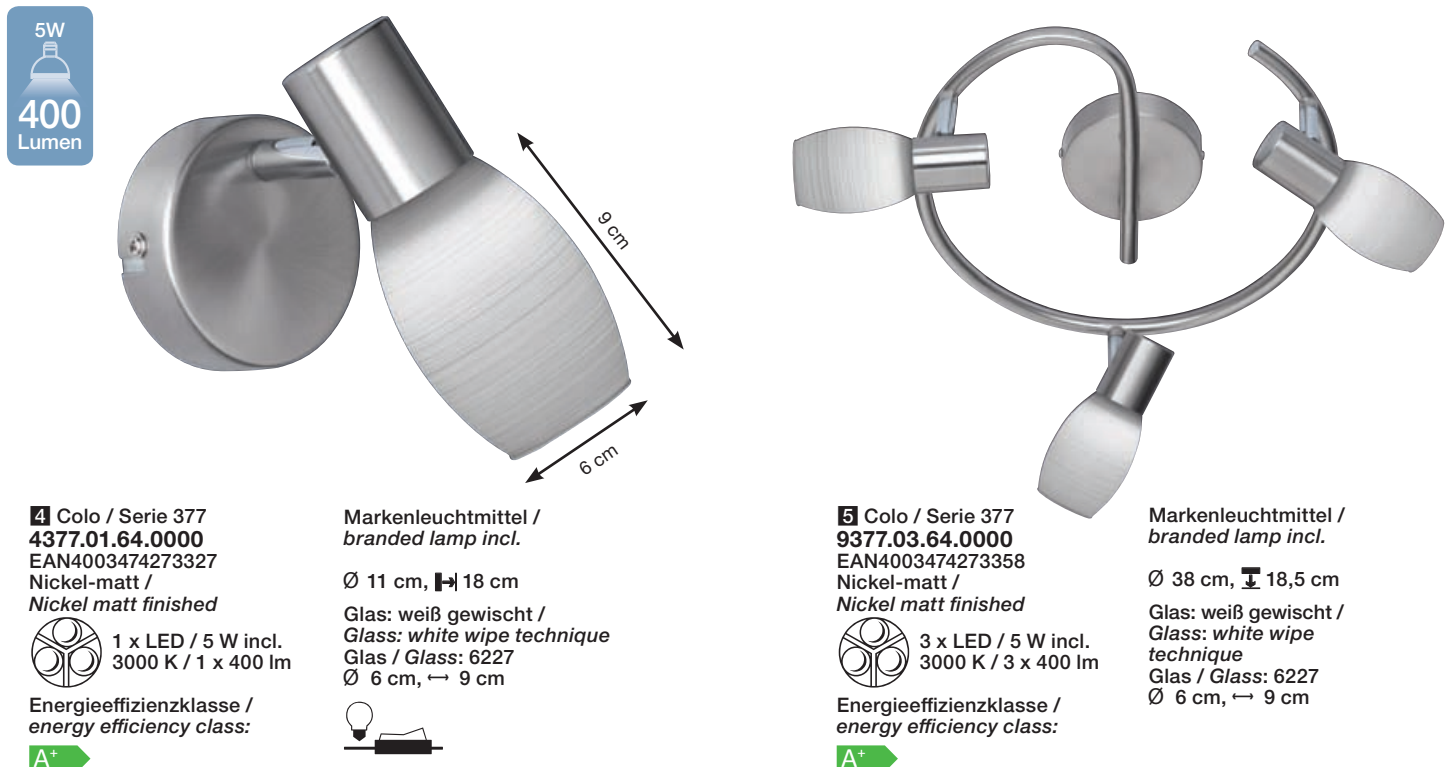

4 Colo / Serie 377
4377.01.64.0000
 EAN4003474273327
 Nickel-matt /
 Nickel matt finished

1 x LED / 5 W incl.
 3000 K / 1 x 400 lm

Energieeffizienzklasse /
 energy efficiency class:
A+

5W
400
 Lumen

9 cm
 6 cm

Markenleuchtmittel /
 branded lamp incl.

Ø 11 cm, ⊥ 18 cm

Glas: weiß gewischt /
 Glass: white wipe technique
 Glas / Glass: 6227
 Ø 6 cm, ↔ 9 cm

5 Colo / Serie 377
9377.03.64.0000
 EAN4003474273358
 Nickel-matt /
 Nickel matt finished

3 x LED / 5 W incl.
 3000 K / 3 x 400 lm

Energieeffizienzklasse /
 energy efficiency class:
A+

Markenleuchtmittel /
 branded lamp incl.

Ø 38 cm, ⊥ 18,5 cm

Glas: weiß gewischt /
 Glass: white wipe
 technique
 Glas / Glass: 6227
 Ø 6 cm, ↔ 9 cm

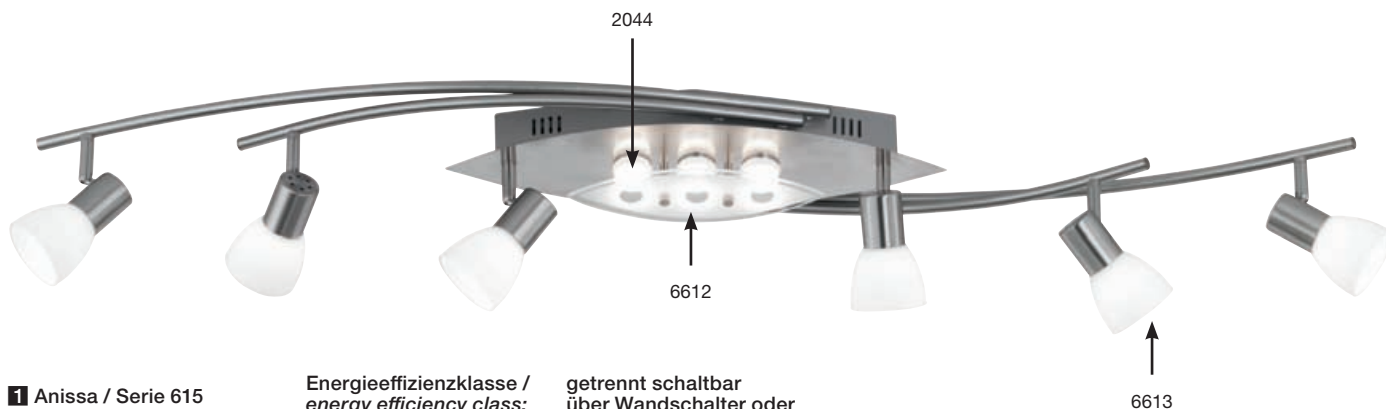

1 Anissa / Serie 615
9615.09.64.0000
 EAN4003474281735
 Nickel-matt /
 Nickel matt finished



Energieeffizienzklasse /
 energy efficiency class:



Markenleuchtmittel /
 branded lamp incl.

↔ 133 cm, ↗ 20,5 cm,
 ↓ 17,5 cm



getrennt schaltbar
 über Wandschalter oder
 Fernbedienung /
 separately switchable by
 wall switch or remote control

Glas / Glass:
 6612: ↔ 24 cm, ↓ 8 cm
 6613: Ø 7 cm
 2044: Ø 3,4 cm

Neu!

Neu!

2 Anissa / Serie 615
9615.07.64.0000
 EAN4003474281728
 Nickel-matt / Nickel matt finished

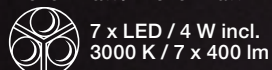

Energieeffizienzklasse /
 energy efficiency class:



Markenleuchtmittel /
 branded lamp incl.

↔ 94 cm, ↗ 18,5 cm,
 ↓ 17 cm

Glas / Glass:
 6612: ↔ 24 cm, ↓ 8 cm
 6613: Ø 7 cm
 2044: Ø 3,4 cm

getrennt schaltbar über Wand-
 schalter oder Fernbedienung /
 separately switchable by wall
 switch or remote control



LED Light
 by **WOFI**



4W

400
 Lumen

3 Anissa / Serie 615
7615.05.64.0000
 EAN4003474281711
 Nickel-matt /
 Nickel matt finished

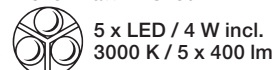

Energieeffizienzklasse /
 energy efficiency class:



Markenleuchtmittel /
 branded lamp incl.

↔ 52 cm, ↗ 13 cm,
 ↓ 19 cm

Glas / Glass:
 6612: ↔ 24 cm, ↓ 8 cm
 6613: Ø 7 cm
 2044: Ø 3,4 cm

getrennt schaltbar über Wandschalter
 oder Fernbedienung /
 separately switchable by wall switch or
 remote control



Spots - glänzend in Form

...These spots are in great shape



1 Quincy / Serie 116
9116.06.01.0000
 EAN4003474251134
 Chrom / Chrome

 6 x GU10 / 2,4 W incl.
 3500 K / 6 x 210 lm

Energieeffizienzklasse /
 energy efficiency class:

A++

↔ 171 cm, ⊥ 14 cm

2 Quincy / Serie 116
7116.03.01.0000
 EAN4003474251073
 Chrom / Chrome

 3 x GU10 / 2,4 W incl.
 3500 K / 3 x 210 lm

Energieeffizienzklasse /
 energy efficiency class:

A++

↔ 61 cm, ⊥ 14 cm



3 Quincy / Serie 116
7116.03.06.0000
 EAN4003474251080
 Weiß / White

 3 x GU10 / 2,4 W incl.
 3500 K / 3 x 210 lm

Energieeffizienzklasse /
 energy efficiency class:

A++

↔ 61 cm, ⊥ 14 cm

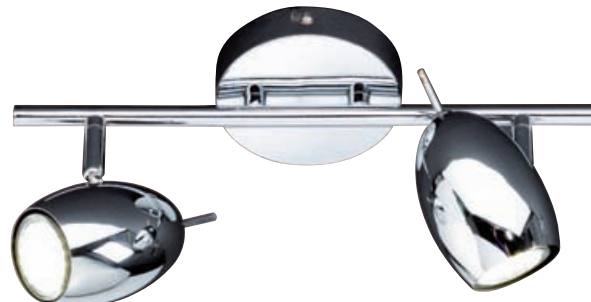
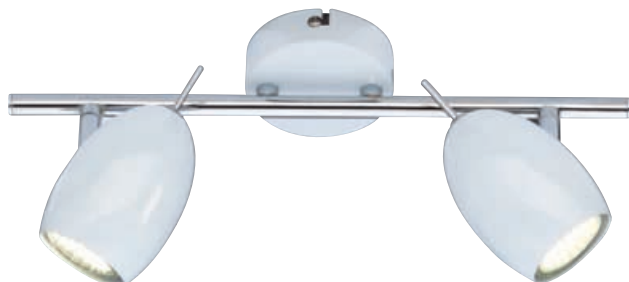

4 Quincy / Serie 116
7116.02.06.0000
 EAN4003474251059
 Weiß / White

 2 x GU10 / 2,4 W incl.
 3500 K / 2 x 210 lm

Energieeffizienzklasse /
 energy efficiency class:

A++

↔ 34 cm, ⊥ 14 cm

5 Quincy / Serie 116
7116.02.01.0000
 EAN4003474251042
 Chrom / Chrome

 2 x GU10 / 2,4 W incl.
 3500 K / 2 x 210 lm

Energieeffizienzklasse /
 energy efficiency class:

A++

↔ 34 cm, ⊥ 14 cm

2,4W
210
Lumen



6 Quincy / Serie 116
4116.01.06.0000
EAN4003474251004
Weiß / White



1 x GU10 / 2,4 W incl.
3500 K / 1 x 210 lm

Energieeffizienzklasse /
energy efficiency class:

A++

Ø 14 cm, H 14 cm



LED Light
by **WOFI**

7 Quincy / Serie 116
4116.01.01.0000
EAN4003474250991
Chrom / Chrome



1 x GU10 / 2,4 W incl.
3500 K / 1 x 210 lm

Energieeffizienzklasse /
energy efficiency class:

A++

Ø 14 cm, H 14 cm



8 Quincy / Serie 116
9116.06.06.0000
EAN4003474251141
Weiß / White



6 x GU10 / 2,4 W incl.
3500 K / 6 x 210 lm

Energieeffizienzklasse /
energy efficiency class:

A++

↔ 171 cm, H 14 cm

LED Light
by **WOFI**



1 Quincy / Serie 116

3116.03.06.0000

EAN4003474250960

Weiß / White



3 x GU10 / 2,4 W incl.
3500 K / 3 x 210 lm

Energieeffizienzklasse /
energy efficiency class: **A++**

A++

↑ 143 cm, ↔ 28 cm



2 Quincy / Serie 116

3116.03.01.0000

EAN4003474250953

Chrom / Chrome



3 x GU10 / 2,4 W incl.
3500 K / 3 x 210 lm

Energieeffizienzklasse /
energy efficiency class: **A++**

A++

↑ 143 cm, ↔ 28 cm



2,4W

210
Lumen

Elegante LED Spots

...Elegant led spots

3 Quincy / Serie 116
8116.01.06.0000
 EAN4003474251110
 Weiß / White



1 x GU10 / 2,4 W incl.
 3500 K / 1 x 210 lm

Energieeffizienzklasse /
 energy efficiency class:



↑ 49 cm, ↔ 14 cm



4 Quincy / Serie 116
8116.01.01.0000
 EAN4003474251097
 Chrom / Chrome



1 x GU10 / 2,4 W incl.
 3500 K / 1 x 210 lm

Energieeffizienzklasse /
 energy efficiency class:



↑ 49 cm, ↔ 14 cm



Charmante Drehvorrichtung

Der flexible Reflektor der Serie
 QUINCY lässt sich ganz leicht durch
 den Griff verstellen.

charming turning device

The flexible reflector of the
 QUINCY series can be easily
 adjusted via the handle.



1 Nice / Serie 178
7178.04.01.1000
EAN4003474260228
Chrom / Chrome



4 x GU10 / 2,4 W incl.
3500 K / 4 x 210 lm

Energieeffizienzklasse /
energy efficiency class:

A++

↔ 92 cm, ⊥ 15 cm

Glas / Glass: 7738, Ø 6 cm



2 Nice / Serie 178
7178.02.01.1000
EAN4003474260211
Chrom / Chrome



2 x GU10 / 2,4 W incl.
3500 K / 2 x 210 lm

Energieeffizienzklasse /
energy efficiency class:

A++

↔ 25,5 cm, ⊥ 7 cm, ⊥ 13 cm

Glas / Glass: 7738, Ø 6 cm

Modernes Opalglas, weiß glänzend

Einzigartige Eleganz in Verbindung mit
neuester LED-Technik!

Modern opal glass, white shiny

Unique elegance combined with the latest
in LED technology!



LED Light
by WOFI®

3 Nice / Serie 178
9178.03.01.1000
EAN4003474260235
Chrom / Chrome



3 x GU10 / 2,4 W incl.
3500 K / 3 x 210 lm

Energieeffizienzklasse /
energy efficiency class:

A++

Ø 29 cm, ⊥ 16 cm

Glas / Glass: 7738, Ø 6 cm



2,4W
210
Lumen

4 Nice / Serie 178
4178.01.01.1000
EAN4003474260204
Chrom / Chrome



1 x GU10 / 2,4 W incl.
3500 K / 1 x 210 lm

Energieeffizienzklasse /
energy efficiency class:

A++

↔ 10 cm, ⊥ 10 cm, ⊥ 13 cm

Glas / Glass: 7738, Ø 6 cm

LED Light
by WOFI4W
200
Lumen

1 Noa / Serie 393
7393.04.64.0000
EAN4003474231747
Nickel-matt /
Nickel matt finished

Energieeffizienzklasse /
energy efficiency class:

A⁺

↔ 64 cm, ↓ 19 cm



4 x GU10 / 4 W incl.
3000 K / 4 x 200 lm



2 Noa / Serie 393
7393.02.64.0000
EAN4003474231730
Nickel-matt /
Nickel matt finished

Energieeffizienzklasse /
energy efficiency class:

A⁺

↔ 34 cm, ↓ 19 cm



2 x GU10 / 4 W incl.
3000 K / 2 x 200 lm



3 Noa / Serie 393
4393.01.64.0000
EAN4003474231723
Nickel-matt / Nickel matt finished



1 x GU10 / 4 W incl.
3000 K / 1 x 200 lm

Energieeffizienzklasse /
energy efficiency class:

A⁺

Ø 8 cm, ↳ 13,5 cm



Zylindrisches Leuchten

Schlichte Gestaltung aus hochwertigem Nickel in Verbindung mit modernster LED Technologie lassen die Serie NOA erstrahlen.

Cylindrical reflectors

Simple design made from high-quality nickel in combination with innovative LED technology enable the NOA series to sparkle.



2 Angola / Serie 354

7354.03.64.0000



EAN4003474182803

Nickel-matt /

Nickel matt finished

geeignet für / suitable for
Energieeffizienzklasse /
energy efficiency class:



  3 x E14 /
max. 40 W

Fit for LED

↔ 60 cm, ↓ 14 cm

Glas: weiß lackiert /
Glass: white lacquered
Glas / Glass: 7505,
Ø 7 cm, ↓ 5,6 cm

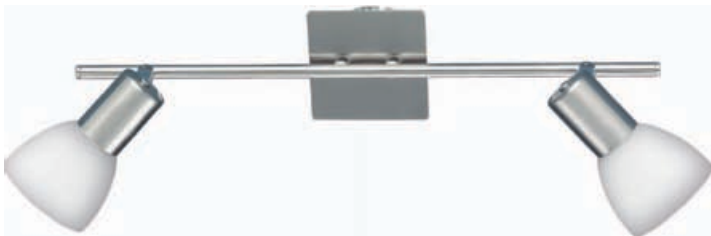

3 Angola / Serie 354

7354.02.64.0000

EAN4003474182797

Nickel-matt /

Nickel matt finished

geeignet für / suitable for
Energieeffizienzklasse /
energy efficiency class:



  2 x E14 /
max. 40 W

Fit for LED

↔ 32 cm, ↓ 14 cm

Glas: weiß lackiert /
Glass: white lacquered
Glas / Glass: 7505, Ø 7 cm, ↓ 5,6 cm



4 Angola / Serie 354

9354.03.64.0000

EAN4003474183404

Nickel-matt /

Nickel matt finished

geeignet für / suitable for
Energieeffizienzklasse /
energy efficiency class:



  3 x E14 /
max. 40 W

Fit for LED



Ø 30 cm, ↓ 14 cm

Glas: weiß lackiert /
Glass: white lacquered
Glas / Glass: 7505,
Ø 7 cm, ↓ 5,6 cm



1 Angola / Serie 354
9354.06.64.0000
 EAN4003474182827
 Nickel-matt /
 Nickel matt finished
 geeignet für / suitable for
 Energieeffizienzklasse /
 energy efficiency class:



  6 x E14 /
 max. 40 W

Fit for LED

↔ 240 cm, ↑ 15 cm

Glas: weiß lackiert /
 Glass: white lacquered
 Glas / Glass: 7505,
 Ø 7 cm, ↑ 5,6 cm

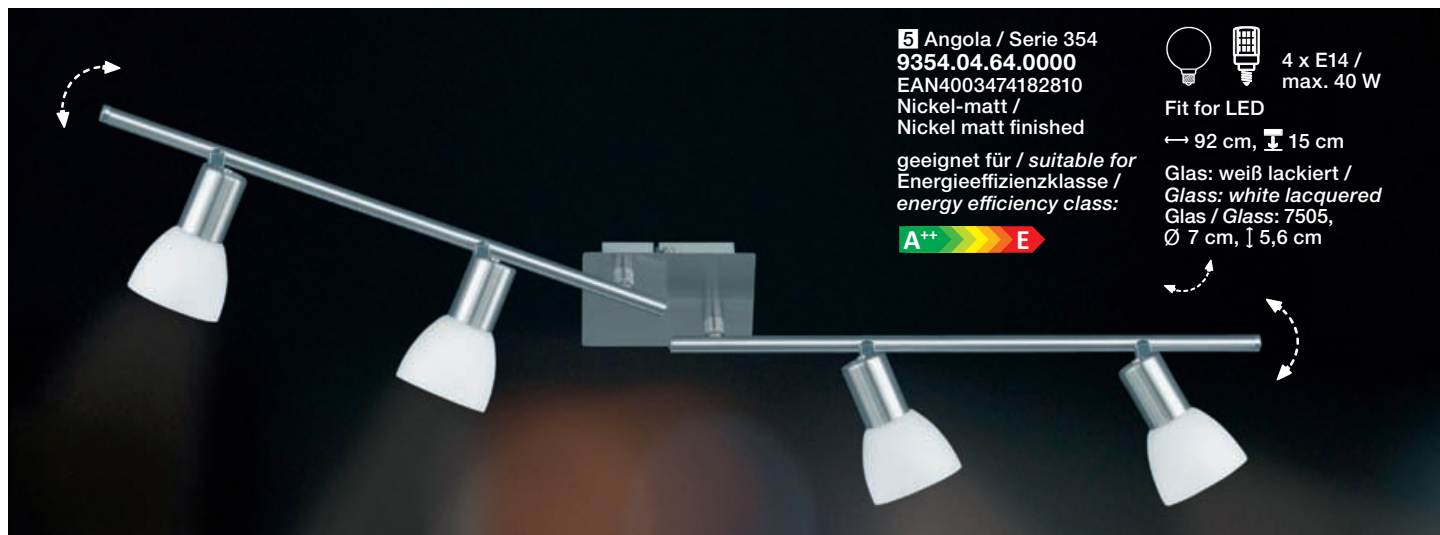

5 Angola / Serie 354
9354.04.64.0000
 EAN4003474182810
 Nickel-matt /
 Nickel matt finished

geeignet für / suitable for
 Energieeffizienzklasse /
 energy efficiency class:



  4 x E14 /
 max. 40 W

Fit for LED

↔ 92 cm, ↑ 15 cm

Glas: weiß lackiert /
 Glass: white lacquered
 Glas / Glass: 7505,
 Ø 7 cm, ↑ 5,6 cm

6 Angola / Serie 354
4354.01.64.0500
 EAN4003474183381
 Nickel-matt /
 Nickel matt finished

geeignet für / suitable for
 Energieeffizienzklasse /
 energy efficiency class:



  1 x E14 /
 max. 40 W

Fit for LED

↑ 8 cm, ↔ 8 cm, ⇄ 24 cm

Glas: weiß lackiert /
 Glass: white lacquered
 Glas / Glass:
 7505, Ø 7 cm, ↑ 5,6 cm



7 Angola / Serie 354
4354.01.64.0000
 EAN4003474182780
 Nickel-matt /
 Nickel matt finished

geeignet für / suitable for
 Energieeffizienzklasse /
 energy efficiency class:



  1 x E14 /
 max. 40 W

Fit for LED

↑ 8 cm, ↔ 8 cm, ⇄ 14 cm

Glas: weiß lackiert /
 Glass: white lacquered
 Glas / Glass:
 7505, Ø 7 cm, ↑ 5,6 cm





*Fein strukturiert
wie Marmor*
...Delicate marbled structures

1 Angola / Serie 354
4354.01.32.1000
EAN4003474206943
Messing-matt /
Brass matt finished

geeignet für / suitable for
Energieeffizienzklasse /
energy efficiency class:



  1 x E14 /
max. 40 W

Fit for LED

↓ 8 cm, ↔ 8 cm, ⇨ 14 cm

Glas: Alabasterfarbig /
Glass: Alabaster coloured
Glas / Glass: 7219, Ø 7 cm



2 Angola / Serie 354
4354.01.32.1500
EAN4003474206950
Messing-matt /
Brass matt finished

geeignet für / suitable for
Energieeffizienzklasse /
energy efficiency class:



  1 x E14 /
max. 40 W

Fit for LED

↓ 8 cm, ↔ 8 cm, ⇨ 24 cm

Glas: Alabasterfarbig /
Glass: Alabaster coloured
Glas / Glass: 7219, Ø 7 cm

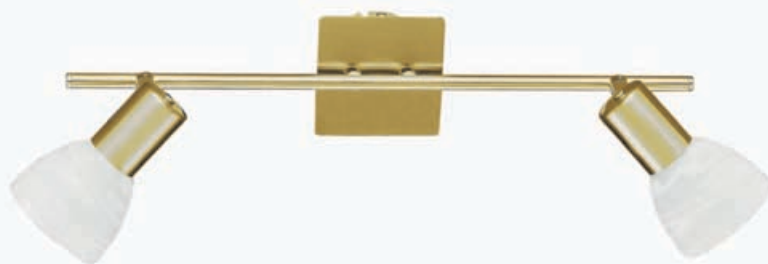

3 Angola / Serie 354
7354.02.32.1000
EAN4003474206967
Messing-matt /
Brass matt finished

geeignet für / suitable for
Energieeffizienzklasse /
energy efficiency class:



  2 x E14 /
max. 40 W

Fit for LED

↔ 32 cm, ↓ 14 cm

Glas: Alabasterfarbig /
Glass: Alabaster coloured
Glas / Glass: 7219, Ø 7 cm

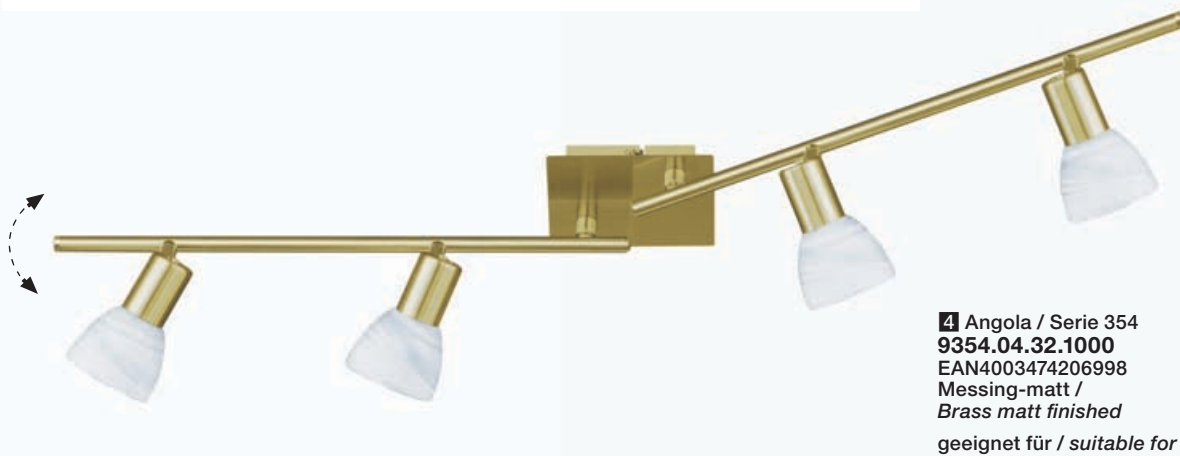

4 Angola / Serie 354
9354.04.32.1000
EAN4003474206998
Messing-matt /
Brass matt finished

geeignet für / suitable for
Energieeffizienzklasse /
energy efficiency class:



  4 x E14 /
max. 40 W

Fit for LED

↔ 92 cm, ↓ 15 cm

Glas: Alabasterfarbig /
Glass: Alabaster coloured
Glas / Glass: 7219, Ø 7 cm





1 Marco / Serie 076
9076.04.01.0000
 EAN4003474248554
 Chrom / Chrome

geeignet für / suitable for
 Energieeffizienzklasse /
 energy efficiency class:



4 x E14 / max. 25 W

Fit for LED

↑ 42 cm, ↔ 42 cm, ⊥ 19,5 cm

Glas: weiß lackiert mit Klarrand
 Glass: white lacquered
 with clear border
 Glas / Glass: 6012,
 Ø 4,5 cm, ↔ 10,5 cm

*Ausgesprochen
 gute Reflexe*
 ...Very impressive reflexes



2 Marco / Serie 076
9076.03.01.0000
 EAN4003474248547
 Chrom / Chrome

geeignet für / suitable for
 Energieeffizienzklasse /
 energy efficiency class:



3 x E14 / max. 25 W

Fit for LED

Ø 36 cm, ⊥ 19,5 cm

Glas: weiß lackiert mit Klarrand
 Glass: white lacquered
 with clear border
 Glas / Glass: 6012,
 Ø 4,5 cm, ↔ 10,5 cm



3 Marco / Serie 076
4076.01.01.0000
 EAN4003474248523
 Chrom / Chrome

geeignet für / suitable for
 Energieeffizienzklasse /
 energy efficiency class:



1 x E14 / max. 25 W

Fit for LED

↑ 15 cm, ↔ 15 cm, ⊥ 20 cm

Glas: weiß lackiert mit Klarrand
 Glass: white lacquered with clear border
 Glas / Glass: 6012,
 Ø 4,5 cm, ↔ 10,5 cm



4 Marco / Serie 076
7076.02.01.0000
 EAN4003474248530
 Chrom / Chrome

geeignet für / suitable for
 Energieeffizienzklasse /
 energy efficiency class:



2 x E14 / max. 25 W

Fit for LED

↑ 12 cm, ↔ 42 cm, ⊥ 19,5 cm

Glas: weiß lackiert mit Klarrand
 Glass: white lacquered with clear border
 Glas / Glass: 6012,
 Ø 4,5 cm, ↔ 10,5 cm

1 Micky / Serie 849
9849.06.64.0000
 EAN4003474168036
 Nickel-matt /
 Nickel matt finished

 6 x G9 / 33 W incl.
 2700 K / 6 x 460 lm

Energieeffizienzklasse /
 energy efficiency class:

D

Markenleuchtmittel /
 branded lamp incl.



↔ 240 cm, ⊥ 14 cm

Glas: weiß lackiert mit Klarrand /
 Glass: white lacquered with
 clear border
 Glas / Glass: 7192,
 Ø 4,2 cm, ⊥ 7 cm



2 Micky / Serie 849
7849.02.64.0000
 EAN4003474167992
 Nickel-matt /
 Nickel matt finished

 2 x G9 / 33 W incl.
 2700 K / 2 x 460 lm

Energieeffizienzklasse /
 energy efficiency class:

D

Markenleuchtmittel /
 branded lamp incl.



↔ 40 cm, ⊥ 14 cm

Glas: weiß lackiert mit Klarrand /
 Glass: white lacquered with clear border
 Glas / Glass: 7192, Ø 4,2 cm, ⊥ 7 cm



4 Micky / Serie 849
4849.01.64.0500
 EAN4003474167985
 Nickel-matt /
 Nickel matt finished

 1 x G9 / 33 W incl.
 2700 K / 1 x 460 lm

Energieeffizienzklasse /
 energy efficiency class:

D

Markenleuchtmittel /
 branded lamp incl.



Ø 7 cm, ⊥ 30 cm

Glas: weiß lackiert mit Klarrand /
 Glass: white lacquered with
 clear border
 Glas / Glass: 7192, Ø 4,2 cm, ⊥ 7 cm



3 Micky / Serie 849
9849.03.64.0000
 EAN4003474168029
 Nickel-matt /
 Nickel matt finished

 3 x G9 / 33 W incl.
 2700 K / 3 x 460 lm

Energieeffizienzklasse /
 energy efficiency class:

D

Markenleuchtmittel /
 branded lamp incl.



Ø 35 cm, ⊥ 14 cm

Glas: weiß lackiert mit Klarrand /
 Glass: white lacquered with
 clear border
 Glas / Glass: 7192, Ø 4,2 cm, ⊥ 7 cm



5 Micky / Serie 849
4849.01.64.0000
 EAN4003474167978
 Nickel-matt /
 Nickel matt finished

 1 x G9 / 33 W incl.
 2700 K / 1 x 460 lm

Energieeffizienzklasse /
 energy efficiency class:

D

Markenleuchtmittel /
 branded lamp incl.



Ø 7 cm, ⊥ 14 cm

Glas: weiß lackiert mit Klarrand /
 Glass: white lacquered with
 clear border
 Glas / Glass: 7192, Ø 4,2 cm, ⊥ 7 cm



33W

460
 Lumen

Die schönen Details des Designs auf mattem Nickel bringen das weiß lackierte Glas besonders gut zur Geltung. Die praktischen Funktionen runden das Gesamtbild perfekt ab.

Beautiful design details on matt finished nickel create the perfect setting for the white lacquered glass. Convenient functions round out the overall design.



33W
460
Lumen

6 Micky / Serie 849
7849.03.64.0000
EAN4003474168005
Nickel-matt /
Nickel matt finished

 3 x G9 / 33 W incl.
2700 K / 3 x 460 lm

Energieeffizienzklasse /
energy efficiency class:

D

Markenleuchtmittel /
branded lamp incl.

 HALOGEN
EDU

↔ 60 cm, ⊥ 14 cm

Glas: weiß lackiert mit Klarrand /
Glass: white lacquered with clear border
Glas / Glass: 7192, Ø 4,2 cm, ⊥ 7 cm



7 Micky / Serie 849
7849.04.64.0000
EAN4003474168067
Nickel-matt / Nickel matt finished

 4 x G9 / 33 W incl.
2700 K / 4 x 460 lm

Energieeffizienzklasse /
energy efficiency class:

D

Markenleuchtmittel /
branded lamp incl.

 HALOGEN
EDU

↔ 70 cm, ⊥ 14 cm

Glas: weiß lackiert mit Klarrand /
Glass: white lacquered with clear border
Glas / Glass: 7192, Ø 4,2 cm, ⊥ 7 cm





1 Sleeve-Vetro / Serie 631
7631.02.64.0000
 EAN4003474173603
 Nickel-matt /
 Nickel matt finished

Markenleuchtmittel /
 branded lamp incl.



2 x G9 / 33 W incl.
 2700 K / 2 x 460 lm

↔ 40 cm, ⊥ 15 cm

Glas: opal weiß /
 Glass: opal white
 Glas / Glass: 7492,
 Ø 6,2 cm, ↓ 5 cm

Energieeffizienzklasse /
 energy efficiency class:



2 Sleeve-Vetro / Serie 631
4631.01.64.0000
 EAN4003474173580
 Nickel-matt /
 Nickel matt finished

Markenleuchtmittel /
 branded lamp incl.



1 x G9 / 33 W incl.
 2700 K / 1 x 460 lm

↳ 15 cm, Ø 7 cm

Glas: opal weiß /
 Glass: opal white
 Glas / Glass: 7492,
 Ø 6,2 cm, ↓ 5 cm

Energieeffizienzklasse /
 energy efficiency class:



3 Sleeve-Vetro / Serie 631
4631.01.64.0500
 EAN4003474173597
 Nickel-matt /
 Nickel matt finished

Markenleuchtmittel /
 branded lamp incl.



1 x G9 / 33 W incl.
 2700 K / 1 x 460 lm

↳ 30 cm, Ø 7 cm

Energieeffizienzklasse /
 energy efficiency class:

Glas: opal weiß /
 Glass: opal white
 Glas / Glass: 7492,
 Ø 6,2 cm, ↓ 5 cm





1 Nixon / Serie 218
7218.02.64.0000
 EAN4003474246604
 Nickel-matt /
 Nickel matt finished

 2 x G9 / 33 W incl.
 2700 K / 2 x 460 lm

Energieeffizienzklasse /
 energy efficiency class:



Markenleuchtmittel /
 branded lamp incl.



↔ 41,5 cm, ⊥ 20 cm

Glas: weiß lackiert /
 Glass: white lacquered
 Glas / Glass: 6037,
 Ø 7 cm, ↓ 7 cm



2 Nixon / Serie 218
4218.01.64.0000
 EAN4003474246598
 Nickel-matt /
 Nickel matt finished

 1 x G9 / 33 W incl.
 2700 K / 1 x 460 lm

Energieeffizienzklasse /
 energy efficiency class:



Markenleuchtmittel /
 branded lamp incl.



Ø 8 cm, ⊥ 18 cm

Glas: weiß lackiert /
 Glass: white lacquered
 Glas / Glass: 6037,
 Ø 7 cm, ↓ 7 cm



3 Nixon / Serie 218
9218.06.64.0000
 EAN4003474246635
 Nickel-matt /
 Nickel matt finished

 6 x G9 / 33 W incl.
 2700 K / 6 x 460 lm

Energieeffizienzklasse /
 energy efficiency class:



Markenleuchtmittel /
 branded lamp incl.



↔ 180 cm, ⊥ 20 cm

Glas: weiß lackiert /
 Glass: white lacquered
 Glas / Glass: 6037,
 Ø 7 cm, ↓ 7 cm



33W

460
 Lumen



4 Nixon / Serie 218
7218.04.64.0000
 EAN4003474246628
 Nickel-matt /
 Nickel matt finished

 4 x G9 / 33 W incl.
 2700 K / 4 x 460 lm

Energieeffizienzklasse /
 energy efficiency class:



Markenleuchtmittel /
 branded lamp incl.



↔ 68 cm, ⊥ 20 cm

Glas: weiß lackiert /
 Glass: white lacquered
 Glas / Glass: 6037,
 Ø 7 cm, ↓ 7 cm

5 Nixon / Serie 218
7218.03.64.0000
 EAN4003474246611
 Nickel-matt /
 Nickel matt finished

 3 x G9 / 33 W incl.
 2700 K / 3 x 460 lm

Energieeffizienzklasse /
 energy efficiency class:



Markenleuchtmittel /
 branded lamp incl.



↔ 48 cm, ⊥ 20 cm

Glas: weiß lackiert /
 Glass: white lacquered
 Glas / Glass: 6037,
 Ø 7 cm, ↓ 7 cm





1 Nini / Serie 669
7669.04.64.0000
 EAN4003474155968
 Nickel-matt /
 Nickel matt finished

 4 x GU 10 / 50 W incl.
 2800 K / 4 x 330 lm

Energieeffizienzklasse /
 energy efficiency class:

D

↔ 70 cm, ↓ 14 cm

2 Nini / Serie 669
7669.02.64.0000
 EAN4003474155944
 Nickel-matt /
 Nickel matt finished

 2 x GU 10 / 50 W incl.
 2800 K / 2 x 330 lm

Energieeffizienzklasse /
 energy efficiency class:

D

↔ 32 cm, ↓ 14 cm



50W

330
 Lumen

3 Nini / Serie 669
9669.06.64.0000
 EAN4003474150147
 Nickel-matt /
 Nickel matt finished

 6 x GU 10 / 50 W incl.
 2800 K / 6 x 330 lm

Energieeffizienzklasse /
 energy efficiency class:

D

↔ 240 cm, ↓ 15 cm

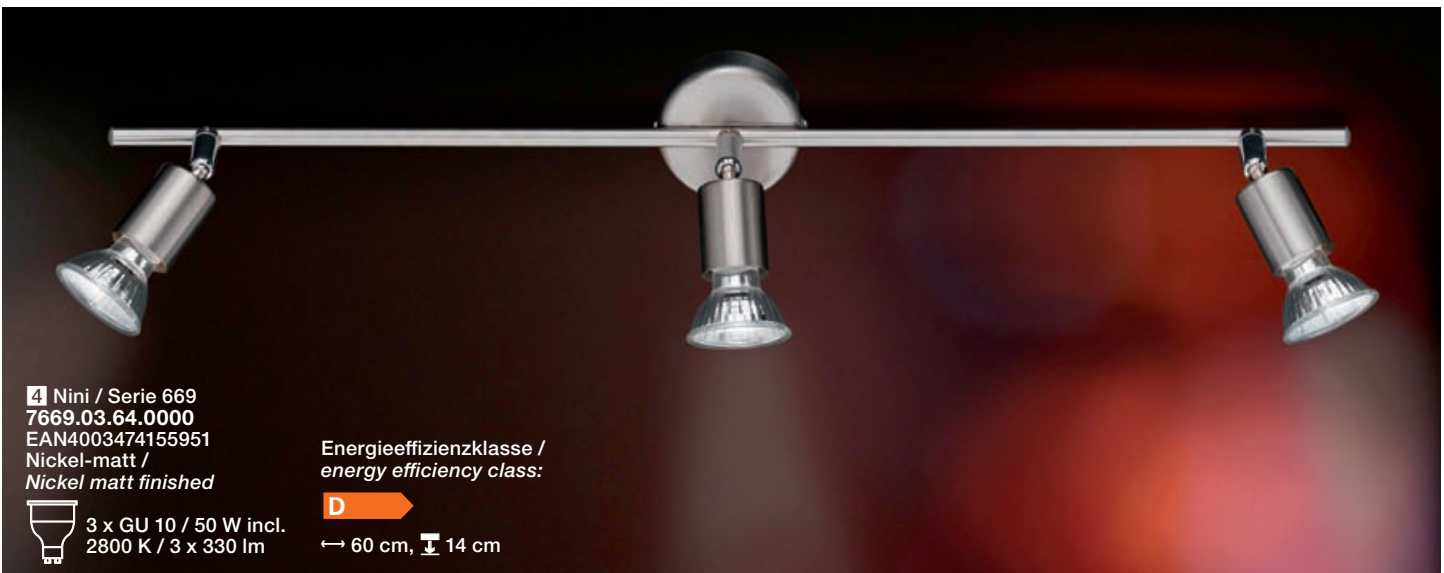

4 Nini / Serie 669
7669.03.64.0000
 EAN4003474155951
 Nickel-matt /
 Nickel matt finished

 3 x GU 10 / 50 W incl.
 2800 K / 3 x 330 lm

Energieeffizienzklasse /
 energy efficiency class:

D

↔ 60 cm, ↓ 14 cm



5 Nini / Serie 669
9669.04.64.0000
 EAN4003474146409
 Nickel-matt /
 Nickel matt finished
 4 x GU 10 / 50 W incl.
 2800 K / 4 x 330 lm

Energieeffizienzklasse /
 energy efficiency class:

D

↔ 92 cm, ⊥ 14 cm

50W

330
 Lumen

6 Nini / Serie 669
4669.01.64.0000
 EAN4003474155920
 Nickel-matt /
 Nickel matt finished

Energieeffizienzklasse /
 energy efficiency class:

D

∅ 7 cm, ⊥ 14 cm

 1 x GU 10 / 50 W incl.
 2800 K / 1 x 330 lm

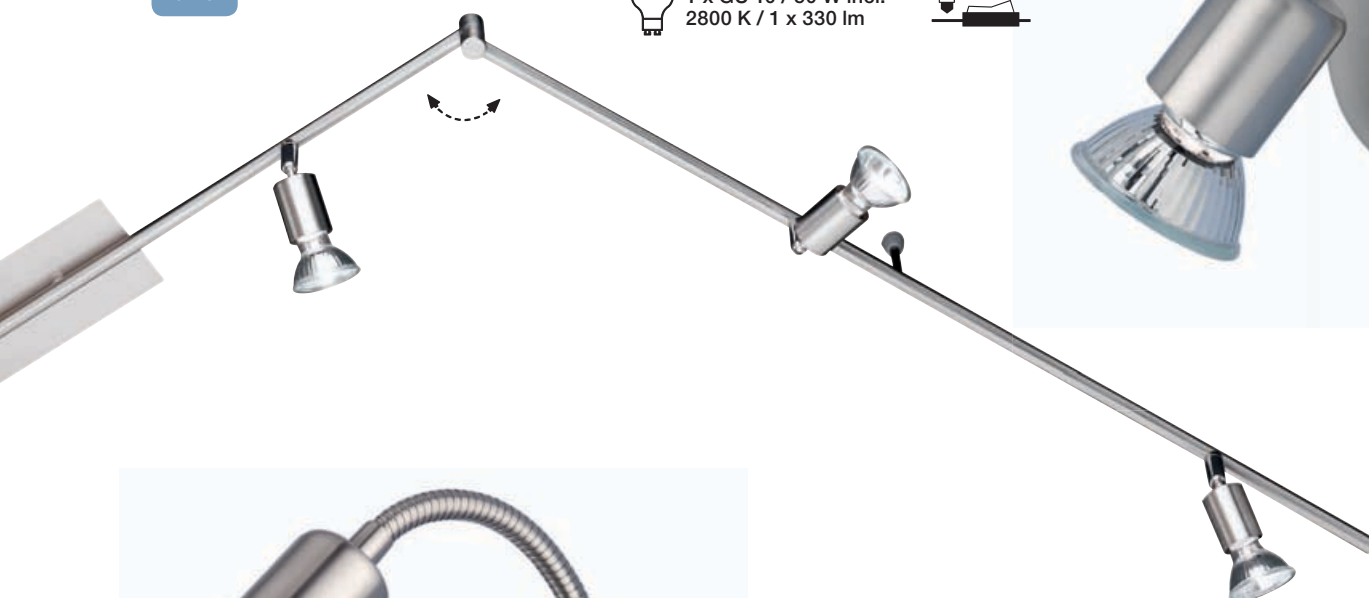

7 Nini / Serie 669
4669.01.64.0500
 EAN4003474155937
 Nickel-matt /
 Nickel matt finished
 1 x GU 10 / 50 W incl.
 2800 K / 1 x 330 lm

Energieeffizienzklasse /
 energy efficiency class:

D

∅ 7 cm, ⊥ 30 cm



Minimalismus für Anspruchsvolle

...Minimalism for discerning minds

Vornehme
 Zurückhaltung

Upscale
 restraint

Ein Minimum an Design und
 ein Maximum an Funktionalität
 bilden die Grundlage der
 Serie NINI.

Minimal design and utmost
 practicality are the foundation
 for the NINI series.



Außenleuchten

...Exterior lamps

Garantiert Allwettertauglich

Unsere speziell entwickelten
Outdoor-Modelle holen die schönsten
Lichtstimmungen nach draußen.

Suitable for any weather

Our exterior lights are designed to set the
perfect mood.

Lua | 248



1 Lua / Serie 308
8308.01.06.0300
 EAN4003474179186
 Weiß / White

geeignet für / suitable for
 Energieeffizienzklasse /
 energy efficiency class:



1 x E27 /
 max. 25 W

Fit for LED
 Ø 30 cm



2 Lua / Serie 308
8308.01.06.0500
 EAN4003474179209
 Weiß / White

geeignet für / suitable for
 Energieeffizienzklasse /
 energy efficiency class:



1 x E27 /
 max. 60 W

Fit for LED
 Ø 50 cm



3 Lua / Serie 308
8308.01.06.0400
 EAN4003474179193
 Weiß / White

geeignet für / suitable for
 Energieeffizienzklasse /
 energy efficiency class:



1 x E27 /
 max. 60 W

Fit for LED
 Ø 40 cm

LUA Outdoorleuchten

- Leuchten aus opalweißem und bruchsicherem (PE) Kunststoff
- Glatte Oberfläche, dadurch:
- UV- und Wärmestabil, Wetterfest, unempfindlich gegenüber Schmutz
- Temperaturbeständig -40°C bis +70°C
- 5 Meter lange Gummileitung inkl. Netzstecker
- Schutzklasse 2, Schutzisoliert
- Schutzart IP67, Wasserdicht
- Bestückbar mit Allgebrauchslampen E27
- Lieferung mit beiliegendem Erdspeiß
- Lieferung ohne Leuchtmittel

LUA Outdoor lamps

- opal white and break-proofed plastic (PE)
- plane surface for less sediment
- UV- and heat-stabilised
- temperature-resistant from -40°C to +70°C
- 5 m rubber cable with shaped plug
- protection class 2
- IP67
- E27 GLS socket (bulb excl.)
- spike included

UNSER AUSSENDIENST (INLAND)
OUR SALES REPRESENTATIVES (NATIONAL)



NORDDEUTSCHLAND

JENS GEBERS

Löwenzahnstr. 13
D - 29643 Neuenkirchen

Phone 05195 / 453
Fax 05195 / 437
Mobile 0171 / 6938950
Email Jens.Gebers@wofi.de



WESTDEUTSCHLAND

FRITZ BLOME

Wintrop 19
D - 59846 Sundern-Dörnholthausen

Phone 02933 / 2316
Fax 02933 / 77126
Mobile 0171 / 4178100
Email Fritz.Blome@wofi.de



SÜD-WESTDEUTSCHLAND

DIETMAR BERTUS

Neustr. 12
D - 56237 Deesen

Phone 02626 / 923728
Fax 02626 / 924650
Mobile 0171 / 6236008
Email Dietmar.Bertus@wofi.de



SÜDDEUTSCHLAND
BADEN-WÜRTTEMBERG

THOMAS KRAUSS

Mühlbachstr. 36
D - 88662 Überlingen

Phone 07551 / 838765
Fax 07551 / 972787
Mobile 0171 / 8010777
Email Thomas.Krauss@wofi.de



SÜDDEUTSCHLAND
BAYERN

MAXIMILIAN REINER
CHRISTIAN HUBER

Arbeostr. 5a
D - 85386 Eching

Phone 089 / 3195766-65
Fax 089 / 3195764
Mobile 0172 / 9310554 (M. Reiner)
Mobile 0172 / 9310555 (C. Huber)
Email Maximilian.Reiner@wofi.de



OSTDEUTSCHLAND

JÜRGEN RUSCHER

Ferdinand-Schumann-Str. 10
D - 08141 Reinsdorf

Fax 0375 / 3909952
Mobile 0171 / 6236005
Email Juergen.Ruscher@wofi.de



OSTDEUTSCHLAND

UDO SCHMIDT

Schillerstr. 12
D - 01454 Radeberg

Fax 03528 / 446212
Mobile 0171 / 6236017
Email Udo.Schmidt@wofi.de



DEUTSCHLAND



AUSTRIA

HERMANN THONHAUSER

Franz Weigand Weg 18
A- 9431 St. Stefan

Fax + 49 (0) 2903 / 449 48 133

Mobile + 43 (0) 664 / 4 05 09 55

Email hermann.thonhauser@wofi.de



CROATIA / SLOVENIA /
BOSNIA-HERZEGOVINA

ZELJKO CONDRIĆ

Management Service
Billrothstr. 2/42
A-1190 Wien

Mobile + 385 9 17 89 06 69

Email condric-rev@hotmail.de



FINLAND / ESTONIA

JUSSI VIROLAINEN

Suomen Sähkötuonti Oy
Electro Import Finland Ltd.
Elimäenkatu 9B,
FI-00510 Helsinki

Phone + 358 50 32 68 550

Fax + 358 20 741 1667

Email jussi.virolainen@sahkotuonti.fi

Web www.suomensahkotuonti.fi



BELGIUM

LUXEMBOURG

DIRK FRANCK

Light Things Benelux
LT Coppens / Ruiterschool 14
B-2930 Brasschaat

Phone + 32 3 455 93 59

Fax + 32 3 455 33 59

Email info@lightthings.be



CZECHIA / SLOVAKIA

GEORG ECKHARDT

WOFI Deutschland
Im Langel 6
D-59872 Meschede

Phone + 49 2903 449 162

Fax + 49 2903 449 180

Email georg.eckhardt@wofi.de

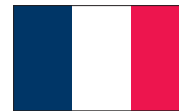

FRANCE

XAVIER LIEBL

LX France Sarl
119 Rue Grenette
F-69400 Villefranche-Sur-Saône

Est / Rhone Alpes / Centre / Sud-Est:

Phone + 33 (0) 4 69 17 60 01

Quest / Sud-Quest:

Phone + 33 (0) 4 69 17 60 02

Paris / Nord:

Phone + 33 (0) 4 69 17 60 03

Centrales d'Achats:

Phone + 33 (0) 4 69 17 60 04

Fax + 33 (0) 4 74 09 99 27

Email wofi@lxfrance.com



BULGARIA

ALEXANDER MISHEV

Wofi jsc
39 Industrialna
Primo Center, 1/F
BG-8000 Burgas

Phone + 359 895 30 40 40

Email a.mishev@wofi.bg



DENMARK

SØREN ROHDE

Retail Support
Denmark ApS
Hejredalsvej 5
DK-8220 Brabrand

Phone + 45 7121 0021

Email sr@wofi.dk

Web www.wofi.dk

UNSER AUSSENDIENST OUR SALES REPRESENTATIVES



HUNGARY

TIBOR UNTERBERGER

Hetven Barack KFT
Barackvirág u. 70
H-2000 Szentendre

Phone + 36 26 31 59 07
Fax + 36 26 31 59 07
Mobile + 36 30 93 17 226
Email utibor@mail.datanet.hu



NETHERLANDS

DIRK FRANCK

Light Things BeNeLux
LT Coppens / Ruiterschool 14
B-2930 Brasschaat

Rep: Raymond Hoogendoorn
Phone + 32 3 455 93 59
Fax + 32 3 455 33 59
Mobile + 31 621 83 84 35
Email info@lightthings.be



PORTUGAL

NUNO SANTOS

Candilamp Iluminação e Decoração Lda
Av. Eng° Duarte Pacheco, 67
P-8315-104 Almancil

Phone + 351 289 39 10 73
Fax + 351 289 39 10 74
Mobile + 351 962 32 78 78
Web info@candilamp.pt

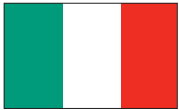

ITALY

VINCENZA SCACCIAFERRO

Fhc srl
Via Stazione 94
I-26013 Crema (CR)

Phone + 39 0 373 20 48 39
Fax + 39 0 373 20 48 45
Email
vincenza.scacciaferro@teamwings.com



POLAND

RAFAŁ FLISZEWSKI

Bestlamp s.c.
ul. E.Orzeszkowej 4
PL-86-032 Niemcz

Phone + 48 52 32 00 319
Fax + 48 52 55 29 664
Mobile + 48 606 488 226
Email rafal.fliszewski@bestlamp.pl



ROMANIA

IONUT CHITULESCU

Prevederii, Nr. 13A, BL M1C, AP 135
RO-032294 Bucuresti, Sector 3

Mobile + 40 7305 125 14
Email ionut.chitulescu@gmail.com



MALTA

SYLVAN MICALLEF

MF Electrix
245, S.Psaila
MT-B'Kara BKR9078

Phone + 356 214 949-55/-56
Fax + 356 214 949 57
Mobile + 356 99498316
Email info@mfelectrix.com.mt
www.mfelectrix.com.mt



PORTUGAL

PAULO PINHEIRO

Dislamp, Lda
Covão
P-3750-802 Valongo do Vouga

Phone + 351 234 64 41 48
Fax + 351 234 64 43 34
Email dislamp@dislamp.pt



GREAT BRITAIN / IRELAND

IAN DORMER

Luminess Ltd.
17 Wye Estate, London Road
High Wycombe
HP11 1LH, UK

Phone + 44 (0) 14 94 44 22 64
Email office@luminess-ltd.co.uk
www.luminess-ltd.co.uk



SPAIN

JOSÉ MANUEL GOLVANO

Aptdo. 74059
E-28050 Madrid

Mobile + 34 670854557

Email wofi@decoluz21.es



TURKEY

GEORG ECKHARDT

WOFI Deutschland
Im Langel 6
D-59872 Meschede

Phone + 49 2903 449 162

Fax + 49 2903 449 180

Email georg.eckhardt@wofi.de



EUROPA

Für alle anderen, nicht aufgeführten Länder
kontaktieren Sie bitte:

For all the other countries please contact:

WOFI DEUTSCHLAND

GEORG ECKHARDT

D-59872 Meschede

Phone + 49 2903 / 449162

Fax + 49 2903 / 449180

Email georg.eckhardt@wofi.de



SWEDEN / NORWAY

PETTER KARLSSON

Bodima
Södra Karstorps Byaväg 28
SE-26972 Förslöv

Phone + 46 708 529 218

Email p.karlsson@bodima.se

Web www.rs-sweden.se



UKRAINE

VALERIY KOPP

PPU Furmann
Uliza 600 - Letija 36
UA-21021 Winnyzja

Phone + 38 (0) 4 32 56 00 18

Fax + 38 (0) 4 32 56 00 18

Mobile + 38 (0) 9 67 00 99 66

Email info@wofi.com.ua



USA / CANADA / MEXICO

ALAN LEVY

WOFI Lighting Americas Inc.
3618 Quantum Boulevard
USA-Boynton Beach FL 33426

Phone + 1 561 424 2444, Ext. 212

Mobile + 1 561 866 8357

Fax + 1 561 424 2440

Email alevy@zenarolighting.com



SWITZERLAND

BORIS SCHÖNENBERGER

Mondilux AG
Gewerbstraße 12
CH-4450 Sissach

Phone + 41 (61) 9 76 92 00

Fax + 41 (61) 9 76 92 10

Email info@mondilux.ch

QUALITÄT UND SICHERHEIT

WOFI-LEUCHTEN werden nach der aktuellen Norm EN60598 entwickelt und gefertigt. WOFI hat ein Qualitätssicherungssystem (TQM). Die diesbezüglichen Prozesse sind unter anderem in einem Ablaufdiagramm definiert.

Alle Leuchten und Bauteile, Bearbeitungs- und Veredelungsverfahren, sowie deren Auszeichnungen, entsprechen ausschließlich den aktuellsten Normen und Regelwerken für den europäischen Binnenmarkt:

- Produktsicherheitsgesetz (ProdSG) vom 08.11.2011
- Niederspannungsrichtlinie 2006/95/EG
- Elektromagnetische Verträglichkeit EMV 2004/108/EG
- Elektro- und Elektronik-Altgeräte WEEE 2012/19/EU
- EG-Richtlinie 2011/65/EU zur Beschränkung der Verwendung bestimmter gefährlicher Stoffe in Elektrogeräten (RoHS 2)
- Ökodesign-Richtlinie 2009/125/EG Anforderungen an die umweltgerechte Gestaltung energieverbrauchsrelevanter Produkte (ErP)
- Anforderungen an die umweltgerechte Gestaltung von Haushaltslampen mit ungebündeltem Licht (244/2009/EG) und von Lampen mit gebündeltem Licht, LED Lampen und dazugehörigen Geräten (1194/2012/EU).

Die Leuchten sind transportsicher und umweltfreundlich in Wellpappkartonagen verpackt. In unseren Laboratorien werden regelmäßig Prüfungen bezüglich Funktion und Sicherheit, sowie bei Leuchtmitteln Lebensdauerprüfungen, durchgeführt. Sollte dennoch ein Fehler auftreten, setzen Sie sich bitte umgehend mit Ihrem Fachhändler oder direkt mit unserer Serviceabteilung in Verbindung.

TRANSFORMATOREN

1. Ringkerntransformatoren

Der Eisenkern ist als Ring aufgebaut, um den dann die Kupferspulen gewickelt werden.

Hinweis: Bei ungedimmten und besonders bei gedimmten Transformatoren kann ein leichtes Brummgeräusch nicht ausgeschlossen sein.

2. Elektronische Transformatoren

Diese so genannten Schaltnetzteile bieten eine lastunabhängige Sekundärspannung, einen Lampenschonenden Softstart, Überlast- und Kurzschlusschutz, kleinste Bauformen, keine Brummgeräusche.

DIMMEN VON LEUCHTEN MIT EINGEBAUTEM TRANSFORMATOR

Für jeden Transformator gibt es einen entsprechenden Dimmer:

1. Block- und Ringkerntransformatoren

Diese Art Transformatoren werden nach dem Phasen-

anschnittprinzip gedimmt. Sie benötigen zum Dimmen einen Dimmer für Eisenkern-Transformatoren. Wir empfehlen Ihnen den Dimmer Typ 2247 Fabrikat Busch-Jäger.

2. Elektronische Transformatoren

Elektronische Transformatoren werden nach dem Phasenabschnittprinzip gedimmt. Sie benötigen zum Dimmen einen Dimmer für elektronische Transformatoren. Wir empfehlen Ihnen den Dimmer Typ 6513 Fabrikat Busch-Jäger.

LEUCHTMITTEL/LAMPEN – LICHT-/LAMPENTECHNOLOGIE

Es gibt verschiedene Möglichkeiten der Lichterzeugung, unterschiedliche Prinzipien und Nutzung verschiedener Medien. Daraus und aus lichttechnischen Entwicklungen, ergeben sich Aspekte zur Charakterisierung einer Lampe bzw. Lichtquelle. Dazu gehören sowohl Eigenschaften der Lichtqualität wie Lichtfarbe, Farbwiedergabe und die spektrale Zusammensetzung, aber auch die elektrische Leistung (W), die mittlere Lebensdauer (h), die Lichtleistung/Lichtstrom (Lumen) und die Beleuchtungsstärke (Lux). Hinzu kommen Aspekte, die für den Einsatz in speziellen Umgebungen wichtig sein können (z.B. UV-Emission, Wärmeabstrahlung, Umgebungstemperatur) und äußere Merkmale wie Lampenform, Sockelart und Baugröße. Nicht zu vernachlässigen sind ökonomische Faktoren wie Preis bzw. Preis-Leistungs-Verhältnis und die Umweltverträglichkeit.

Im Folgenden wird ein Einblick in die von WOFI-LEUCHTEN eingesetzten Lampentypen und deren wesentlichen Eigenschaften gegeben.

1. Glühlampen

Glühlampen erzeugen Licht, indem sie mit elektrischem Strom einen Wolframdraht zum Glühen bringen. Dabei wird Energie über einen weiten homogenen Wellenbereich ausgestrahlt, ähnlich der spektralen Verteilung des Tageslichtes im sichtbaren Bereich.

→ Klassische Glühlampe

Die Klassische Glühlampe setzt den Großteil der zugeführten Energie in Wärme um (96%) und nur einen geringen Anteil in Licht. Sie gehört zu den Temperaturstrahlern. Das erzeugte Licht ist ein sehr angenehmes und warmes Licht bei sehr guter Farbwiedergabe (1A). Durch die Zugabe von Edelgasen (Argon und Krypton) kann die Lichtausbeute und die Lebensdauer erhöht werden. Die Sockelform E14 bzw. E27 ermöglicht ein breites Sortiment verschiedener Typen. Allgebrauchs-Glühlampen haben eine mittlere Lebensdauer von ca. 1.000 h. Spannungsspitzen führen zu frühzeitiger Zerstörung, Dimmen hingegen kann die Lebensdauer verlängern.

→ Halogen-Glühlampe

Die Zugabe von Halogenen verhindert das Verdampfen von Wolfram und somit eine Kolbenschwärzung.

Es wird eine hohe und konstante Lichtausbeute erzielt. Dadurch entsteht ein brillantes Licht bei sehr guter Farbwiedergabe (1A). Die störende UV-Emission, die z.B. das Ausbleichen von Farben beschleunigt, kann durch entsprechende UV-Filter vermieden werden. Der Lampenkolben ist aus Quarzglas, um gegen die Halogene resistent zu sein. Die Lebensdauer der Halogenglühlampen ist je nach Typ sehr unterschiedlich. Dimmen erhöht die Lebensdauer. Die verschiedenen Typen unterscheiden sich auch in der Sockelform, was beim Lampenwechsel beachtet werden muß.

Man unterscheidet:

(A) Hochvolt-Halogen-Glühlampe



Hochvolt-Halogen-Glühlampen werden direkt mit Netzspannung versorgt. Sie sind aufwendig herzustellen, erreichen je nach Typ Leistungsaufnahmen bis 500 W und eine Lebensdauer bis 2.000 h.

(B) Niedervolt-Halogen-Glühlampe



Niedervolt-Halogen-Glühlampen benötigen einen Transformator (Umwandlung der Netzspannung in Schutzkleinspannung, in der Regel 12V). Niedervolt-Halogen-Glühlampen haben sehr kleine Abmessungen, die kleinen Wendel und entsprechende Reflektoren bewirken eine gerichtete effiziente Lichtlenkung. Die maximale Leistung beträgt 100W, die mittlere Lebensdauer je nach Typ ca. 2.000 h bis 4.000 h.

→ IRC-Technologie (Infra-Red-Coating)



Eine spezielle Beschichtung des Lampenkolbens reflektiert die erzeugte Wärme zurück auf die Glühwendel, um diese auf Betriebstemperatur zu halten. Das Ergebnis ist eine um ca. 30% höhere Lichtausbeute und damit eine entsprechende Energieeinsparung. Die IRC-Technologie wird sowohl bei Hoch- als auch bei Niedervoltlampen eingesetzt.

2. Leuchtstofflampen

Leuchtstofflampen sind Gasentladungslampen in Niederdrucktechnik. Für den Betrieb ist ein Vorschaltgerät notwendig. Der zylindrische Glaskolben ist mit einem Gasgemisch gefüllt. An den Enden sind jeweils Elektroden. Bei angelegter Spannung emittiert das Gasgemisch ultraviolettes Licht, das an der Innenseite des Glaskolbens durch dort aufgebrachte Leuchtstoffe in sichtbares Licht umgewandelt wird. Die Mischung und Qualität dieser Beschichtung ist entscheidend für die Lichtfarbe und Farbwiedergabe (1A, 1B) der Leuchtstofflampe. Leuchtstofflampen zeichnen sich durch einen geringen Stromverbrauch bei hoher Lichtleistung und eine lange Lebensdauer aus. Dabei wird kaum Wärme erzeugt. Negative Bewertungen des Leuchtstofflampenlichtes, wie z.B. Brummen und Flackern, unnatürliche Farben und ungemütliche Wirkung sind mit moderner Technik und bei richtiger Auswahl des Leuchtmittels nicht festzustellen.

Hinweis: Leuchtstofflampen gehören nicht in den Hausmüll sondern ins Recycling der kommunalen Sammelstelle.

→ Leuchtstofflampe in Stabform



Die unterschiedlichen Bezeichnungen resultieren aus den verschiedenen Bauformen und Abmessungen. Ausschlaggebend für die Bezeichnung ist der Glaskolbendurchmesser in Millimeter bzw. Zoll, z.B. T26 bzw. T8, T16 bzw. T5

Leuchtstofflampen benötigen Vorschaltgeräte, elektronische bzw. verlustarme magnetische Geräte kommen bei T8 Lampen zum Einsatz. T5 Lampen sind ausschließlich mit elektronischen Vorschaltgeräten zu betreiben, mit u. a. folgenden Vorteilen: erhöhte Lebensdauer und Lichtausbeute um ca. 25%, flackerfreier Sofortstart und flimmerfreier Betrieb, sowie Abschalten bei Fehlfunktion, auch häufiges Ein- und Ausschalten wirkt sich nicht negativ aus. Die mittlere Lebensdauer liegt bei 12.000 h, T5 bis 20.000 h. Für den Dimmereinsatz sind spezielle Elektronik erforderlich, das Dimmen erfolgt farbstabil, also ohne Änderung der spektralen Strahlungskurve.

Eine Sonderform stellen die Leuchtstofflampen in Ringform dar, die flache Leuchtenformen mit rotations-symmetrischer Lichtverteilung ermöglichen.

→ Kompaktleuchtstofflampe (Energiesparlampe ESL)



Sie haben, dem Namen entsprechend, eine kompakte Bauform, bei einer Vielfalt von Abmessungen, Leistungsstufen sowie Glaskolben- und Sockelformen. Die Farbwiedergabe ist mit 1B als gut zu bewerten, die Lebensdauer reicht je nach Typ von 6.000 h bis 15.000 h. Vor allem die Energiesparlampen (ESL) mit integriertem Vorschaltgerät und einem herkömmlichen Schraubsockel (E14, E27) verdrängen trotz höherer Investitionskosten immer mehr die Glühlampe aus dem energiebewussten Haushalt.

3. LED (Licht Emittierende Diode)



LED (Leuchtdioden) sind Halbleiterdioden und gehören zu den Elektrolumineszenz-Strahlern. Durch die Steigerung der Effizienz und der Entwicklung weißer LED ist der Einsatz der Leuchtdioden auch auf dem Gebiet der Beleuchtung möglich geworden.

LED basieren auf Halbleiterverbindungen, die den Strom direkt in Licht umwandeln. Bezogen auf Größe, Effektivität, Haltbarkeit und Lebensdauer verhalten sich die Leuchtdioden zu konventionellen Glühlampen wie Halbleiterdioden zu Röhrendioden. Sie werden die Beleuchtungstechnik in ähnlicher Weise verändern, wie die Halbleitertechnologie schon die Elektronik verändert hat.

ALLGEMEINE INFORMATIONEN

Mittels LED werden zukünftig WOFI-LEUCHTEN realisiert, die in ihrer Form, Lichtwirkung, Regelbarkeit und anderen Eigenschaften völlig neuartig sind. Es lassen sich gerichtetes Licht abgebende, zwei- oder dreidimensional flächige oder lineare Leuchten mit beliebiger Kontur realisieren. Jede LED gibt gerichtetes Licht ab, die Lichtfarbe ist bei Einsatz farbiger LED regelbar. Die Farbwiedergabe von LED-Licht kann durch mehrere Spektralbereiche zu 1A zusammengesetzt werden.

Lichtausbeute (lm/W)

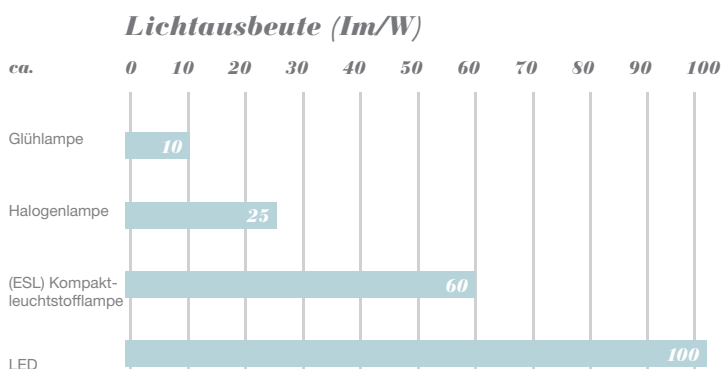

Lebensdauer

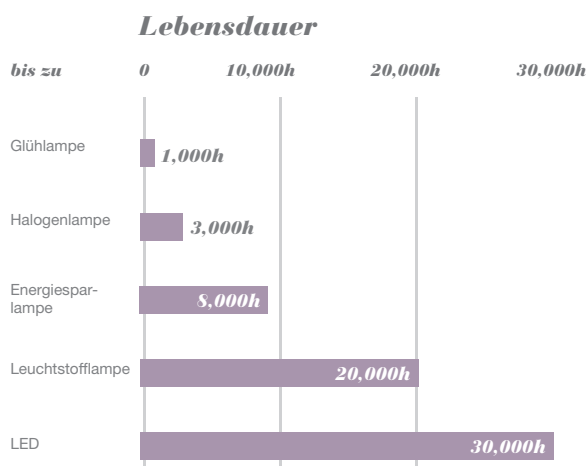

Lichtfarbe in Kelvin

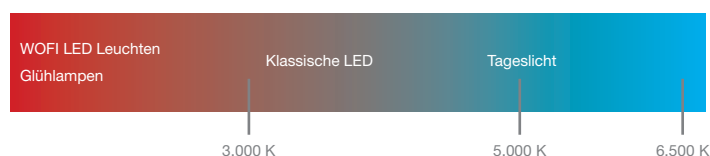

Folgende Dimmer sind für den Einsatz bei unseren Pendelleuchten geeignet

Hersteller	Dimmer Bestellnummer	Beschreibung
Berker	286710	Tronic Drehdimmer 20-360W
GIRA	0307 00	Tronic Dimmer-Einsatz 20-525W
Jung	225TDE	Tronic Drehdimmer 20-525W
Peha	433HAB-60	Tronic Drehdimmer; Phasenabschnitt 20-250W
Siemens	5 TC8 284	NV-Dimmer-Einsatz für elektr. Trafos 20-525VA

ERKLÄRUNG LICHTTECHNISCHER BEGRIFFE

Lumen

Der Lichtstrom (Lumen; lm) ist die von einer Lichtquelle in alle Richtungen ausgestrahlte und nach der international festgelegten Augenempfindlichkeit bewertete Strahlungsleistung. Die Werte für den Lichtstrom der Lichtquelle sind in den Produktlisten der Lampenhersteller angegeben.

Lux

Die Beleuchtungsstärke (Lux; lx) gibt an, wie viel Licht auf eine Flächeneinheit fällt. Die für künstliche Beleuchtung erforderlichen Beleuchtungsstärken sind in DIN-Normblättern angegeben.

Lichtausbeute

Die Lichtausbeute ist das Maß für die Wirtschaftlichkeit einer Lichtquelle. Sie sagt aus, wie viel Lumen pro Watt aus einer Lampe herauskommen. Je höher das Verhältnis Lumen/Watt (lm/W), desto wirtschaftlicher ist die Lichtquelle.

Lichtfarbe

Die Lichtfarbe einer Lampe wird charakterisiert mit dem Begriff der „Farbtemperatur“, angegeben in der Temperatur-Maßeinheit Kelvin (K). Eine Glühlampe mit ihrem warmweißen Licht hat z.B. eine Farbtemperatur von 2700 K, eine hellweiße Leuchtstofflampe eine Farbtemperatur von 4000 K und eine tageslichtähnliche Leuchtstofflampe 5000 K.

GLÄSER

Mundgeblasene Gläser

Bei mundgeblasenen Gläsern handelt es sich um frei geformte Gläser – keine industrielle Fertigung. Somit ist jedes Glas ein Unikat. Kleine Luft einschüsse im Glas sind daher kein Reklamationsgrund, sondern ein Merkmal für handwerkliche Glaskunst.

SCHUTZBEREICHE FÜR DIE ANWENDUNG VON LEUCHTEN IM BADEZIMMER

Badezimmer sind Feuchträume. Wo Elektrizität und Feuchtigkeit zusammentreffen, ist besondere Vorsicht geboten. Im Interesse der Sicherheit gibt es deshalb spezielle Vorschriften, um Gefahren und Unfälle zu vermeiden. Drei so genannte Schutzbereiche für Badezimmer sind in der Norm DIN VDE 0100 Teil 701 festgelegt.

Schutzbereich 0

Er umfasst den unmittelbaren Innenraum der Badewanne oder Duschwanne, beispielsweise bei Einsatz von Unterwasserleuchten. Dabei dürfen ausschließlich Betriebsmittel mit Schutzkleinspannung bis maximal 12 Volt eingesetzt werden, welche ausdrücklich für die Installation im Wanneninnenbereich zugelassen sind. Sie müssen mindestens in der Schutzart IP X7 eingestuft sein. Schutzkleinspannung bedeutet, dass ein Stromkreis mit geringer Spannung von Stromkreisen höhere Spannung gespeist wird, von diesen aber sicher getrennt sein muss.

Schutzbereich 1

Er umschreibt eine Fläche innerhalb der senkrechten Begrenzungen von Wanne oder Dusche. Ist keine Duschwanne vorhanden, gilt der Radius von 120 Zentimetern rund um den Brausekopf in Ruhelage. Die untere Begrenzung ist der Fußboden, nach oben hin wird eine waagerechte Fläche in 2,25 Metern Höhe über dem Fußboden angenommen. Auch im Schutzbereich 1 dürfen nur Leuchten mit Schutzkleinspannung bis maximal 12 Volt zum Einsatz kommen. In den Bereichen 1 und 0 dürfen sich keine Transformatoren befinden.

Schutzbereich 2

Er grenzt an Bereich 1 mit einer Tiefe von 60 Zentimetern an. In den Bereichen 1 und 2 müssen Leuchten mindestens in die Schutzart IP X4 eingestuft sein, bei Geräten mit Strahlwasser, beispielsweise Massagedrüsens, ist die Schutzart IP X5 erforderlich.

Duschen oder Wanne besitzen generell nur den Schutzbereich 1. Im sonstigen Raum gelten keine besonderen Schutzbestimmungen. Steckdosen und Schalter sind in den Bereichen 0, 1 und 2 nicht zulässig. Sofern sie die Schutzart nicht herabsetzen, sind allerdings in Leuchten eingebaute Schalter zugelassen. Mantelleitungen zu Leuchten dürfen über und unter Putz verlegt werden, Stegleitungen lediglich unter Putz mit einer Tiefe von mindestens sechs Zentimetern.

Unter Schutzart versteht man die Einstufung der Betriebssicherheit von Leuchten. Sie wird im IP-Code (Ingress Protection) angegeben, der zwei Kennziffern trägt. Wird eine der beiden Kennziffern nicht angegeben, so steht dafür ein X. Während die erste Kennziffer sich auf die Widerstandsfähigkeit gegen Festkörper und Staub bezieht, ist für Badleuchten vor allem die zweite Ziffer von Belang, bei der es um das Verhältnis zu Wasser und Feuchtigkeit geht.

Des Weiteren werden für Leuchten drei Schutzklassen unterschieden, welche den Umfang von Vorkehrungen gegen elektrischen Schlag darstellen:

Schutzklasse I

Leuchten für den Anschluss an den netzseitigen Schutzleiter.

Schutzklasse II

Leuchten mit einer zusätzlichen oder verstärkten Isolierung ohne Schutzleiteranschluss.

Schutzklasse III

Leuchten für den Betrieb mit Schutzkleinspannung.

SCHEMATISCHE DARSTELLUNG DER SCHUTZBEREICHE FÜR WANNEN UND DUSCHEN JEWELNS MIT UND OHNE FEST EINGEBAUTE TRENNWAND

Wannen:

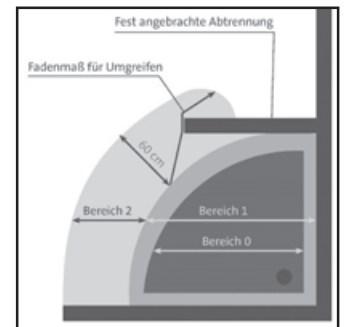
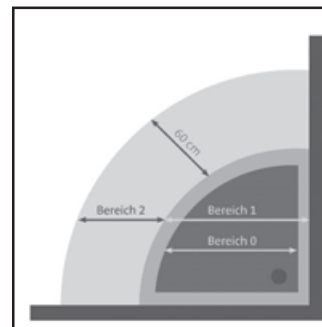

• Feste Wasseraustrittsstelle

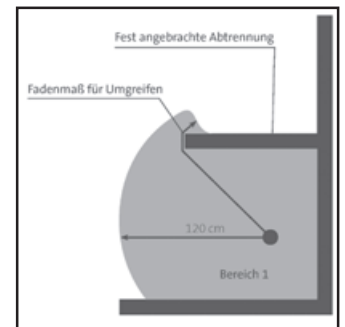
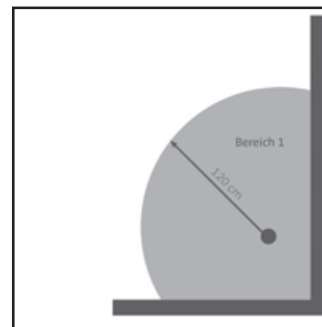

Duschen:



• Feste Wasseraustrittsstelle







ALLGEMEINE INFORMATIONEN

ERSTE KENNZIFFER (BERÜHRUNGSSCHUTZ)

Erste Kennziffer	Höhe der Schutzarten Kurzbeschreibung	Schutz gegen das Eindringen von Fremdkörpern und Staub
IP 0X	ungeschützt	Kein besonderer Schutz
IP 1X	Schutz gegen Fremdkörper > 50 mm	Größere Körperteile wie z.B. eine Hand (jedoch keine Schutzmaßnahme gegen absichtliche Berührung) Fremdkörper > 50 mm Durchmesser
IP 2X	Schutz gegen Fremdkörper > 12 mm	Finger und dergleichen bis 80 mm Länge. Feste Fremdkörper > 12 mm Durchmesser
IP 3X	Schutz gegen Fremdkörper > 2,5 mm	Werkzeuge, Drähte usw. mit Durchmesser oder Dicke > 2,5 mm Fremdkörper > 2,5 mm Durchmesser
IP 4X	Schutz gegen Fremdkörper > 1 mm	Drähte oder Streifen dicker als 1 mm. Fremdkörper > 1 mm Durchmesser
IP 5X	Staubschutz 	Eindringen von Staub wird nicht völlig verhindert, aber Staub dringt nicht in solchen Mengen ein, dass ordnungsgemäßer Betrieb behindert wird.
IP 6X	Staubdicht 	Kein Eindringen von Staub

Die hier abgebildeten Tabellen spiegeln die Höhe der Kennziffer und den damit einhergehenden Schutz wieder. Vielfach ergibt sich auch ein Zusammenhang zwischen den beiden Kennziffern. Wenn also die Leuchte **IP X5** entspricht, kann bei üblichen Aufbau **IP 6X** erreicht werden.

ZWEITE KENNZIFFER (WASSERSCHUTZ)

Zweite Kennziffer	Höhe der Schutzarten Kurzbeschreibung	Schutz gegen das Eindringen von Fremdkörpern und Staub
IP X0	ungeschützt	Kein besonderer Schutz
IP X1	Schutz gegen Tropfwasser 	Tropfwasser (senkrecht fallende Tropfen) verursacht keine Schädigung.
IP X2	Schutz gegen Tropfwasser unter 15°	Senkrecht fallende Tropfen dürfen keine Schädigung bewirken, wenn das Gehäuse bis zu 15° aus seiner bestimmungsgemäßen Gebrauchslage gekippt wird.
IP X3	Schutz gegen Sprühwasser 	Sprühwasser darf aus einer Neigung bis 60° gegen die Senkrechte keine Schädigung verursachen.
IP X4	Schutz gegen Spritzwasser 	Spritzwasser aus beliebiger Richtung darf keine Schädigung verursachen.
IP X5	Schutz gegen Strahlwasser 	Strahlwasser aus einer Düse aus einer beliebigen Richtung darf keine Schädigung verursachen.
IP X6	Schutz gegen schwere See	Schwere See oder Strahlwasser unter hohem Druck dürfen nicht in gefahrbringender Menge in das Gehäuse eindringen.
IP X7	Schutz gegen Eintauchen 	Eindringen von Wasser in gefahrbringender Menge darf beim Eintauchen in Wasser unter vorgegebenen Bedingungen hinsichtlich Druck und Zeit nicht stattfinden
IP X8	Schutz gegen Untertauchen 	Das Gerät ist unter Bedingungen, die vom Hersteller genannt werden, für Dauerbetrieb unter Wasser geeignet. Anmerkung: Üblicherweise bedeutet dies, dass das Gerät vollständig abgedichtet ist. Jedoch kann dies bei bestimmten Geräten auch bedeuten, dass Wasser zwar eindringt, jedoch keine Schädigung verursacht.

Beispiel: **IP 54** bedeutet, dass das Betriebsmittel gegen Staubablagerung im Innern und gegen Spritzwasser geschützt ist.

QUALITY UND SAFETY

WOFI LEUCHTEN are developed and manufactured according to the latest EN60598 standards. WOFI operates a (TQM) quality assurance system. The processes covered by the TQM system are set out in a flowchart and in other documentation.

All our lamps, components, machining and finishing processes and corresponding accreditation comply with the latest standards and regulations for the internal European market:

- Product Safety Act (ProdSG) dated 08.11.2011
- the Low Voltage Directive 2006/95/EG
- the Electromagnetic Compatibility Directive EMC 2004/108/EG
- the Waste Electrical and Electronic Equipment Directive WEEE 2012/19/EU
- Directive 2011/65/EU on the restriction of the use of certain hazardous substances in electrical equipment (RoHS 2)
- Ecodesign Directive 2009/125/EG.
Establishing a framework for the setting of ecodesign requirements for energy-related products (ErP)
- Regulation (EC) 244/2009 on non directional household lamps as an implementing measure of the directive on ecodesign requirements and directional lamps, LED lamps and related equipment (1194/2012/EU).

The lamps are packaged in environmentally friendly corrugated cardboard for safe transport. Our laboratory staff carry out regular operating and safety tests as well as checks on the lifetime of the lighting materials we use. Should you nevertheless encounter a fault, please contact your specialist dealer or the WOFI customer support desk as soon as possible

TRANSFORMERS

1. Ring core transformers

The iron core is in the form of a ring around which copper coils are wound.

Important note: A slight humming noise is always possible when using undimmed and especially dimmed transformers.

2. Electronic transformers

These 'switch network' components offer load-independent secondary voltage and a soft start mechanism that prolongs the life of the lamp. Overload and short circuit protection are also included in a compact unit that is totally noise-free.

DIMMING LAMPS WITH BUILT-IN TRANSFORMERS

There is a corresponding dimmer for every transformer:

1. Block and ring core transformers

These types of transformer are dimmed according to the phase cut principle. In order to dim, they require a dimmer for iron core transformers. We recommend you use dimmer type 2247 from the firm Busch-Jäger.

2. Electronic transformers

Electronic transformers are dimmed according to the phase section principle. In order to dim, they require a dimmer for electronic transformers. We recommend you use dimmer type 6513 from the firm Busch-Jäger.

LIGHTING MATERIALS / LAMPS – LIGHTING AND LAMP TECHNOLOGY

Light can be produced in a number of ways involving different principles and media. We can use these variations along with developments in lighting technology to describe different forms of lamp or light source. The description includes the properties of the light itself such as colour, colour rendering and spectral composition as well as electrical output (W), average life (h), luminous flux (lumen) and illuminance (lux). We also use lighting properties that could be important for use under specific conditions (e.g. UV emission, heat radiation, ambient temperature) and other characteristics such as the lamp and base design and dimensions. Other important factors include the price and price-performance ratio and of course environmental impact.

We would like to give you an insight into the range of lamps produced by WOFI LEUCHTEN and their main characteristics.

1. Incandescent light bulbs

Light bulbs produce light by using electric current to heat a filament until it glows. The energy generated is radiated across a broad, homogeneous area of the spectrum similar to the distribution of daylight in the visible spectrum.

→ Classic light bulb

The classic light bulb converts most of the energy used into heat (96%) and only a small amount into light. It is a form of thermal radiator. The light generated is a very pleasant and warm light with very good colour rendering (1A). The light output and life of the bulb can be increased by adding noble gases (Argon and Krypton). The base models E14 and E27 make it possible to offer a wide range of different types. All-purpose bulbs have an average life of approx. 1,000 h.

Voltage surges can lead to the early destruction of the bulb, while dimming can extend its life.

→ Halogen bulbs

The addition of halogens prevents the filament from evaporating and blackening the bulb wall. It produces a higher and more constant light output with a brilliant light and very good colour rendering (1A). Unwanted UV emissions, which speed up the colour fading process, for example, can be avoided using appropriate UV filters. The bulb wall is made of quartz which is resistant to the halogens. The lifespan of a halogen bulb varies considerably depending on the model but can be increased substantially through dimming. The base design also varies depending on the bulb type and needs to be considered when changing the bulb.

To differ:

(A) High voltage halogen bulbs

High voltage halogen bulbs work directly with mains voltage. They are costly to produce but can reach an output of 500 W depending on the type and a lifespan of up to 2,000 h.

(B) Low voltage halogen bulbs

Low voltage halogen bulbs need a transformer to convert mains voltage into a low safety voltage – generally 12 V. They are very small, and the tiny coils and corresponding reflectors allow for efficient directional light projection. The maximum output is 100W, and the average lifespan is between 2,000 h and 4,000 h depending on the type.

→ IRC technology (Infra Red Coating)

A special coating on the bulb wall reflects the heat generated back onto the glowing coil in order to maintain it at the correct operating temperature. As a result, it is possible to boost light output by around 30% with a corresponding saving in energy. IRC technology is used in both high voltage and low voltage lamps.

2. Fluorescent lamps

Fluorescent lamps are based on low pressure gas discharge technology. They require a ballast. The cylindrical glass tube is filled with a gas mixture. They are electrodes at each end of the tube. When connected to the power source, the gas mixture emits ultra-violet light which is converted into visible light by the coating material on the inside of the tube. The composition and quality of this coating determines the light colour and colour rendering (1A, 1B) of fluorescent lamps.

Fluorescent lamps are characterised by minimal power consumption alongside a high light output and long lifespan. They produce very little heat. The humming and flickering, unnatural colours and uncomfortable sensation associated with earlier fluorescent lamps have now been eliminated thanks to modern technology and the right choice of fluorescent material.

Important note: Fluorescent lamps should not be disposed of in the ordinary household waste. They should be taken for recycling to the municipal disposal point for hazardous waste.

→ Tubular fluorescent lamps

There are a range of models that differ according to design and size. These lamps are principally distinguished by the diameter of the glass tube in millimetres or inches, e.g. T26 or T8, T16 or T5.

Fluorescent lamps employ ballast devices with T8 lamps using electronic or low-loss magnetic systems. T5 lamps can only be operated using an electronic ballast device. This has a number of advantages. Both lifespan and light output are increased by around 25%; there is an immediate no-flicker start, flicker-free operation and an automatic cut-out in case of fault, as repeated switching on and off can damage the lamp. The average lifespan is around 12,000 h, up to 20,000 h for T5 lamps. A special electronic control system is needed for dimmer operation. This makes it possible to dim the light without affecting the colour quality through changes in the spectral radiation curve.

Fluorescent lamps can also be found in circular form allowing for flat designs that produce a rotationally symmetric distribution of light

→ Compact fluorescent lamp

(Energy saving lamp ESL)

As the name suggests, this type of fluorescent lamp has a compact design. A wide range of sizes, output classes and tube and base designs is available. Colour rendering is in the 1B category (good), while the lifespan lies between 6,000 h and 15,000 h depending on the type. The energy saving lamp (ESL) with its integrated ballast and conventional screw-in base (E14, E27) is increasingly replacing the incandescent bulb in energy conscious households.

3. LED (Light Emitting Diodes)

LEDs (Light diodes) are semi-conductor diodes that work on the principle of electroluminescence. Research aimed at promoting efficiency and the development of white LEDs has made it possible to use light diodes for illumination.

LEDs are based on semi-conductor connections that convert electricity directly into light. In terms of their size, efficiency, durability and lifespan, light diodes represent an improvement over conventional incandescent lamps in the same way that semi-conductor diodes are superior to the diode vacuum tube. They are set to change lighting technology in the same way that semi-conductor technology has changed electronics.

In the future, WOFI LEUCHTEN will use LEDs to produce lamps that are completely new in terms of design, lighting effect, control and other properties. It is possible to make two or three dimensional flat or linear lamps in every conceivable shape that give off directional light. Every LED emits directional light and the light colour can be adjusted by means of colour LEDs. The colour rendering of LED light can be combined through several areas of the spectrum to meet class 1A values.

Light output (lm / W)

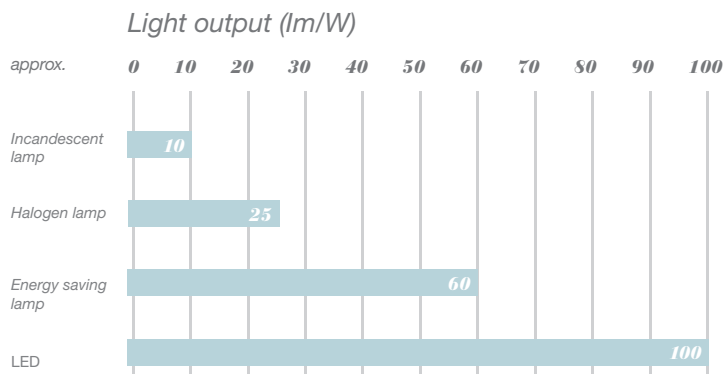

Lifespan

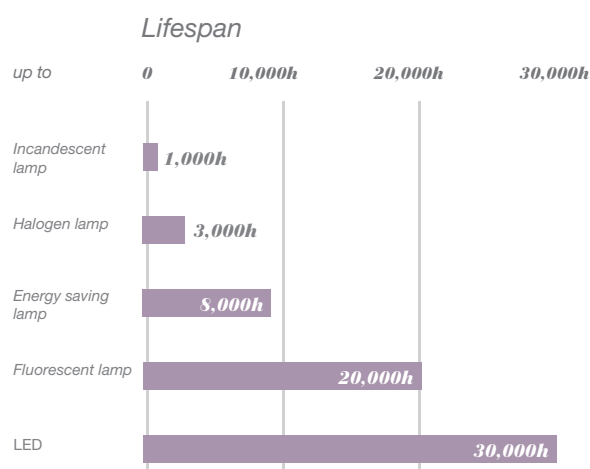

Light colour Kelvin

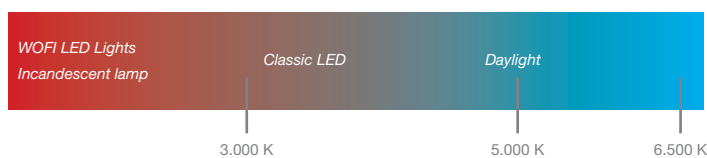

EXPLANATION OF TECHNICAL TERMS

Lumen

Luminous flux (lumen; lm) describes the useful power emitted by a light source in all directions adjusted for the international standard established for human eye sensitivity. The luminous flux values for light sources are given in the product lists of lamp manufacturers.

Lux

The value for illuminance (lux; lx) denotes how much light falls on a unit area of surface. The illuminance values required for artificial lighting are established by German Industrial Standards.

Luminous efficacy

Luminous efficacy is a measure of the efficiency of a light source. It tells us how many lumens per Watt are produced by a lamp: the higher the lumen/Watt ratio (lm/W), the more efficient the light source.

Light colour

The light colour of a lamp can be defined in terms of 'colour temperature' which is measured using the Kelvin (K) temperature scale. For example, an incandescent bulb with its warm white light may have a colour temperature of 2,700 K, a bright white fluorescent lamp 4,000 K and a fluorescent lamp producing near daylight conditions around 5,000 K.

GLASSES

Hand blown glasses

Hand blown glasses are individually made by skilled craftsmen and each glass is unique. Air bubbles within the glass are a sign of manual craftsmanship and are no reason for rejection.

The following dimmers are suitable for use with our pendants

Manufacturer	Dimmer Number	Description
Berker	286710	Tronic Drehdimmer 20-360W
GIRA	0307 00	Tronic Dimmer-Einsatz 20-525W
Jung	225TDE	Tronic Drehdimmer 20-525W
Peha	433HAB-60	Tronic Drehdimmer; Phasenabschnitt 20-250W
Siemens	5 TC8 284	NV-Dimmer-Einsatz für elektr. Trafos 20-525VA

GENERAL INFORMATION

SAFETY ZONES FOR THE USE OF LIGHTS IN THE BATHROOM

Bathrooms are damp rooms, and special care must be taken wherever electricity and damp come together. The following regulations have been drawn up in the interests of safety. They are aimed at avoiding hazards and accidents. Three so-called safety areas for bathrooms are set out in the standard DIN VDE (Germany Industrial Standard, Association of German Electrotechnicians) 0100 Section 701.

Safety area 0

The area inside the bath tub or shower tray, for example when using underwater lights. Only appliances with a protection low voltage of a maximum of 12 Volts may be used; these must be specifically authorised for installation inside baths/shower trays. They must have a protection rating of at least IP X7. Protection low voltage means that higher voltage circuits supply a low voltage circuit; the two must be securely separated.

Safety area 1

This defines the area within the vertical limits of the bath or shower. If there is no shower tray, the upper limit is defined as a radius of 120 centimetres around the shower head when hung up. The lower limit is the floor; the area stretches 2.25 metres above the floor. Safety area 1 also requires the use of protection low voltage lights with a maximum voltage of 12 Volts. There may be no transformers in safety areas 1 or 0.

Safety area 2

This adjoins area 1 and is 60 centimetres deep. Any lights used in areas 1 and 2 must have a protection rating of at least IP X4; for devices which spray jets of water, for example massage jets, lights must have a protection rating of at least IP X5. Showers without shower trays generally only cover area 1.

There are no specific safety requirements for the rest of the room. Plugs and switches may not be installed in areas 0, 1 or 2. However, switches built in to lights are allowed provided they do not reduce the protection rating. Plastic sheathed lighting wiring may be laid underneath or over the plaster; flat webbed house wires may only be laid at least six centimetres below the plasterwork.

The protection rating is lights' operational safety classification. It is expressed in a two-digit IP code (Ingress Protection). If one of the two digits is not given, this is represented by an X. The first digit concerns resistance to solid objects and dust; more important for bathroom lights is the second digit, which relates to resistance/permeability to water and damp.

Three classes of protection are also defined for lights; these set out the scope of protective provisions against electric shocks:

Protection class I

Lights to be connected to the mains earth.

Protection class II

Lights with additional or reinforced insulation with no earth terminal.

Protection class III

Lights for use with protection low voltage.

SCHEMATIC DIAGRAM OF THE SAFETY AREAS FOR BATHTUBS AND SHOWERS, WITH AND WITHOUT A BUILT-IN PARTITION

Bathtubs:

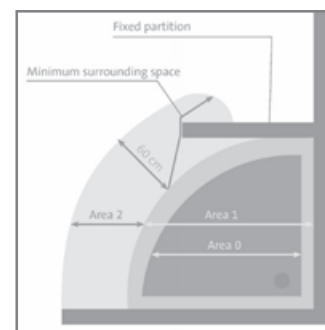
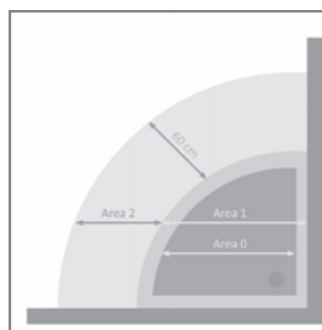

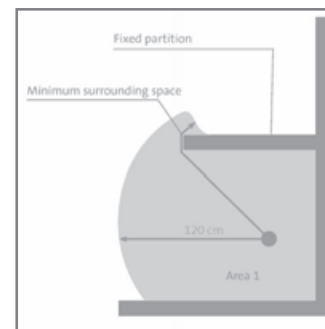
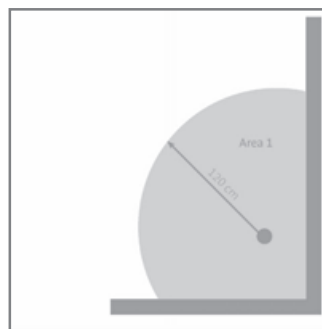

- Fixed plughole

Showers:









- Fixed plughole

FIRST DIGIT (PROTECTION AGAINST CONTACT)

First digit	Level of protection Brief description		Protection against the ingress of foreign bodies and dust
IP 0X	No protection		No special protection
IP 1X	Protected against foreign bodies > 50 mm		Larger body parts e.g. hands (accidental contact only) Foreign bodies > 50 mm diameter
IP 2X	Protected against foreign bodies > 12 mm		Fingers and similar objects up to 80 mm long solid foreign bodies > 12 mm diameter
IP 3X	Protected against foreign bodies > 2.5 mm		Tools, wires etc. with a diameter or thickness > 2.5 mm. Foreign bodies > 2.5 mm diameter
IP 4X	Protected against foreign bodies > 1 mm		Wires or strips thicker than 1 mm. Foreign bodies > 1 mm diameter
IP 5X	Protected against dust		Ingress of dust not completely prevented, but dust does not enter in quantities which inhibit proper operation
IP 6X	Totally protected against dust		No ingress of dust

The tables below reflect the digit rating and the associated level of protection. In many cases, the two digits are also connected: if a lights meets the **IP X5** standard, **IP 6X** can also be met under usual installation conditions.

SECOND DIGIT (PROTECTION AGAINST WATER)

Second digit	Level of protection Brief description		Protection against the ingress of foreign bodies and dust
IP X0	Not protected		No special protection.
IP X1	Protected against dripping water		Dripping water (vertically falling drops) causes no damage.
IP X2	Protected against dripping water when enclosure is tilted up to 15°		Vertically falling drops should cause no damage if the enclosure is tilted by up to 15° from its proper position.
IP X3	Protected against sprayed water		Water sprayed from an angle of 60° shall not cause any damage.
IP X4	Protected against splashed water		Water splashed from a nozzle from any direction shall cause no damage.
IP X5	Protected against water projected in jets		Jets of water projected by a nozzle from any direction shall cause no damage.
IP X6	Protected against heavy seas		Heavy seas and water projected in powerful jets shall not enter the enclosure in harmful quantities.
IP X7	Protected against temporary immersion		Water should not penetrate in harmful quantities when the device is briefly immersed under specified pressure and for a specified time.
IP X8	Protected against continuous immersion		In conditions by the manufacturer, the device is suitable for continuous use underwater. Please note: This usually means that the device is completely sealed and watertight. However, with certain devices it can mean that water does ingress, but does not cause any damage.

Example: **IP 54** means that the device is protected against dust collecting inside and against splashed water.

ALLGEMEINE VERKAUFSBEDINGUNGEN

1. Allen unseren Lieferverträgen – auch zukünftigen – liegen unsere allgemeinen Verkaufsbedingungen zugrunde. Spätestens mit der Entgegennahme der Lieferung gelten unsere Bedingungen als angenommen. Einkaufs-, Lieferungs- und Zahlungsbedingungen des Bestellers haben keine Gültigkeit, soweit sie unseren Allgemeinen Verkaufsbedingungen entgegenstehen. Alle bisherigen Bedingungen und Vereinbarungen verlieren mit Erscheinen des Kataloges WOFI LEUCHTEN 2015 ihre Gültigkeit.
2. Auf das Vertragsverhältnis findet ausschließlich deutsches Recht Anwendung.
3. Angebote sind freibleibend und verpflichten uns nicht zur Auftragsannahme.
4. Die durch unsere Vertreter getroffenen Vereinbarungen und mündlichen Absprachen erhalten erst durch unsere schriftliche Bestätigung Rechtsverbindlichkeit.
5. Liefertermine werden nach Möglichkeit eingehalten. Verzögerungen in der Lieferung berechtigen nicht zu Schadenersatzansprüchen. Teillieferungen können durchgeführt werden. Ereignisse höherer Gewalt oder Betriebsstörungen entbinden uns von unserer Lieferungsverpflichtung. Schadenersatzansprüche des Käufers wegen Lieferverzug sind ausgeschlossen. Der Käufer ist nicht berechtigt, vom Vertrag zurückzutreten, ohne eine angemessene Liefernachfrist zu setzen.
6. Die Lieferung erfolgt ab Werk auf Rechnung und Gefahr des Empfängers. Bei Anlieferung mit unseren LKWs innerhalb Deutschlands berechnen wir einen Frachtanteil in Höhe von 6% des Warenwertes
7. Technische Änderungen behalten wir uns vor.
8. Beanstandungen können nur berücksichtigt werden, wenn sie uns innerhalb 8 Tagen nach Lieferung schriftlich mitgeteilt worden sind. Für Beschädigungen auf dem Transport wird grundsätzlich kein Ersatz geleistet. Rücksendungen werden nur nach vorheriger Vereinbarung anerkannt. Für nachweislich mangelhafte Lieferung wird kostenloser Ersatz gewährt. Weitergehende Ansprüche jeder Art sind ausgeschlossen.
9. Unsere Rechnungen sind zahlbar in Euro innerhalb 8 Tagen nach Rechnungsdatum in bar abzüglich 2% Skonto, oder innerhalb 30 Tagen in bar ohne Abzug. Schecks oder Wechsel gelten erst mit der Einlösung als Barzahlung. Bei Überschreiten der Zahlungsfrist berechnen wir 4% über dem jeweiligen Diskontsatz als Verzugszinsen oder Diskontspesen. Kommt der Besteller mit einer Zahlung in Verzug, so werden alle anderen Forderungen sofort zur Zahlung fällig, ohne dass es einer gesonderten Inverzugsetzung bedarf. Die Aufrechnung mit Gegenforderungen des Bestellers ist für alle denkbaren Fälle ausgeschlossen, es sei denn, die Gegenansprüche sind unbestritten oder rechtskräftig festgestellt.
10. Für Lieferungen und Leistungen an Besteller im Ausland gilt als ausdrücklich vereinbart, dass alle Kosten der Rechtsverfolgung durch den Lieferanten im Falle des Zahlungsverzuges des Bestellers sowohl gerichtliche als auch außergerichtliche, zu Lasten des Bestellers gehen.
11. Wir behalten uns für den jeweiligen Kaufvertrag das Eigentum an der gelieferten Ware bis zur völligen Bezahlung des Kaufpreises einschließlich Zinsen und Kosten und bis zur völligen Einlösung der hierfür gegebenen Wechsel und Schecks vor.
12. Die Fa. WOFI LEUCHTEN ist berechtigt, ihre Forderungen aus Lieferungen und Leistungen zu Finanzierungszwecken abzutreten.
13. Erweiterter und verlängerter Eigentumsvorbehalt. Bis zur Bezahlung aller Ansprüche aus der Geschäftsverbindung, einschließlich etwaiger Refinanzierungs- oder Umkehrwechsel behalten wir uns das Eigentum an unseren Warenlieferungen, die nur im ordnungsgemäßen Geschäftsverkehr veräußert werden dürfen, vor, das gilt auch dann, wenn einzelne oder unsere sämtlichen Forderungen in eine laufende Rechnung aufgenommen wurden und der Saldo gezogen und anerkannt ist. Durch eine evtl. Verarbeitung dieser Waren erwirbt der Käufer kein Eigentum an den ganz oder teilweise hergestellten Sachen; die Verarbeitung erfolgt unentgeltlich ausschließlich für den Verkäufer, der Eigentümer der neu hergestellten Sache wird. Der Käufer tritt hiermit die Forderung aus einem Weiterverlauf der Vorbehaltsware ab, und zwar insoweit, als die Ware verarbeitet ist. Er ist ermächtigt, die abgetretenen Forderungen so lange einzuziehen, wie er sein Zahlungspflicht gegenüber uns vertragsmäßig nachkommt. Der Käufer hat uns Zugriffe Dritter auf die unter Eigentumsvorbehalt gelieferten Waren oder die abgetretenen Forderungen sofort mitzuteilen.
14. Jede Teillieferung gilt in Bezug auf Berechnung und Bezahlung, nicht aber hinsichtlich des Eigentumsvorbehaltes, als besonderes Geschäft.
15. Nichteinhaltung der vereinbarten Zahlungsbedingungen oder sonst. Vertragsverletzungen geben uns das Recht unter vorheriger Ankündigung das Zurückbehaltungsrecht für sämtliche noch ausstehenden Lieferungen auszuüben oder Vorauszahlung zu verlangen oder von der Lieferungsverpflichtung ganz zurückzutreten.
16. Erfüllungsort für Lieferung und Zahlung für beide Teile ist Meschede-Freienohl, Gerichtsstand für beide Teile ist Meschede.
17. Die vorstehenden Bedingungen gelten als verbindlich, soweit nicht ausdrücklich schriftlich andere Vereinbarungen getroffen werden.

WOFI LEUCHTEN
Wortmann & Filz GmbH

1. These General Terms and Conditions of Sale apply to all our current and future supply agreements. The customer shall be deemed to have accepted our terms no later than the point at which the goods are received and accepted. Any purchase, supply and payment terms of the ordering party that do not match our own sales terms shall be regarded as invalid. All previous terms and conditions and agreements shall expire on issue of the 2015 WOFI LEUCHTEN catalogue.
2. The contractual relationship shall be subject exclusively to German law.
3. All offers made by WOFI are subject to change without notice and do not constitute an obligation to accept specific orders.
4. Agreements and oral understandings entered into by our representatives only acquire legally binding force when confirmed by us in writing.
5. We make every effort to comply with supply deadlines. Supply delays do not confer an entitlement to compensation. An order may be supplied by means of partial deliveries. Our obligation to deliver may be suspended by incidents of force majeure or operational disruption. The purchaser may not claim compensation for delays in delivery. The purchaser may not cancel the agreement without granting us a suitable extension period in which to supply the goods.
6. Deliveries are made ex factory for the account and at the risk of the recipient. Where the goods are delivered using our own HGV transport within Germany, we shall add a further 6% of the value of the goods to cover shipping.
7. We reserve the right to make technical changes.
8. Complaints can only be considered if they are submitted to us in writing within eight days of delivery. Under no circumstances will we provide replacements for any goods damaged in transit. Goods returned will only be accepted by prior agreement. Replacement goods will be provided free of charge where there is adequate evidence of a faulty delivery. No other claims of any kind will be considered.
9. Our invoices are payable either within 8 days of the invoice date in cash less a discount of 2% or within 30 days in cash without a discount. Cheques and bills of exchange will only be regarded as cash payment once they have been paid out. We will charge 4% above the current discount rate by way of default interest or discount charges on all delayed payments. Once a single invoice falls overdue for payment, all other amounts owed by that customer shall automatically fall due for immediate payment without a requirement for us to issue a specific default notice. The Customer may not under any foreseeable circumstances offset any of its own claims against the amounts it owes unless those claims are either uncontested or legally established.
10. In the case of deliveries made to foreign customers it is expressly agreed that all legal and other costs incurred by the supplier in seeking legal recourse following non-payment of invoices by the customer shall be paid by the ordering party.
11. For each supply agreement, we reserve title to the goods delivered until they have been paid for in full including any interest and costs and up to the complete discharge of any bills or cheques used as payment.
12. Where required for financing purposes, WOFI LEUCHTEN is entitled to assign to a third party its own claims to payment for the goods and services it has supplied.
13. Extended reservation of title. We reserve title to all the goods we supply until we have received full payment for all amounts owed to us from the business transaction including any refinancing or acceptor's bills used. The goods may only be sold in the ordinary course of business. This reservation shall also apply where individual amounts owed to us or our entire claims have been included in a running account and a statement has been produced and the balance accepted. Any further processing of the goods shall not confer a right of title to the partially or fully produced new items; the processing shall be undertaken free of charge exclusively on behalf of the seller who shall acquire title to the newly produced item. The purchaser hereby assigns to us, to the extent that the goods have been reworked, its own claims for payment following any resale of the reserved title goods. The purchaser is entitled to collect the amounts corresponding to these reassigned claims for as long as it meets its own contractual obligation to pay us. The purchaser must inform us immediately of any attempts by third parties to obtain the reserved title goods or the reassigned claims.
14. Each partial delivery shall be considered as a separate transaction with regard to invoicing and payment but not with regard to reservation of title.
15. Where the customer fails to comply with agreed payment terms or with other provisions of the agreement, we shall be entitled, subject to our giving prior notice, to withhold all outstanding deliveries or demand advance payment or withdraw entirely from our obligation to supply the goods in question.
16. For both parties, the place of fulfilment for supply and payment shall be Meschede-Freienohl. The place of jurisdiction for both parties shall be Meschede.
17. The above terms and conditions are binding in the absence of any other expressly written terms agreed between the parties.

WOFI LEUCHTEN
Wortmann & Filz GmbH

INDEX INDEX

Der vorliegende Index ist nach WOFI-Serien-Nummern sortiert. Die drei Ziffern vor dem 1. Punkt geben die genaue Serie an.

The present index participates sorted after WOFI-series-numbers. The three digits before the point declare the exactly series-numbers.

Im Nachfolgenden handelt es sich um die Serie 006.
It is in the following about the series 006.

Serien-Nummer
Series-Number

3006.01.32.9000 WOFI Artikel-Nummer
WOFI Item-Number

Serie Series	Art-Nr. Item-No.	EAN-Nummer EAN-Number	Seite Page	Serie Series	Art-Nr. Item-No.	EAN-Nummer EAN-Number	Seite Page	Serie Series	Art-Nr. Item-No.	EAN-Nummer EAN-Number	Seite Page
006	3006.01.32.9000	4003474261898	157	111	8111.02.64.0510	4003474236285	149	178	7178.02.01.1000	4003474260211	234
	3006.01.64.9000	4003474264738	157	112	8112.02.32.0010	4003474235561	149		7178.04.01.1000	4003474260228	234
	3006.02.32.9000	4003474260372	156		8112.02.64.0010	4003474236308	149		9178.03.01.1000	4003474260235	234
	3006.02.64.9000	4003474264745	156	116	3116.03.01.0000	4003474250953	158	184	4184.01.06.0000	4003474269375	190
	8006.01.64.9500	4003474264752	156		3116.03.01.0000	4003474250953	232		4184.01.64.0000	4003474274065	190
007	4007.05.01.0000	4003474215884	193		3116.03.06.0000	4003474250960	158	187	4187.01.64.0000	4003474154442	191
	9007.11.01.0000	4003474215907	192		3116.03.06.0000	4003474250960	232	192	6192.01.01.0000	4003474269436	110
	9007.16.01.0000	4003474221793	192		4116.01.01.0000	4003474250991	231	193	3193.05.01.0000	4003474284231	047
022	9022.24.01.0600	4003474190457	018		4116.01.06.0000	4003474251004	231		4193.01.01.0000	4003474280714	046
024	6024.01.01.0000	4003474286112	070		7116.02.01.0000	4003474251042	230		4193.01.01.0000	4003474280714	176
	8024.01.01.0000	4003474286129	071		7116.02.06.0000	4003474251059	230		8193.01.01.0000	4003474284248	047
	9024.01.01.0000	4003474286136	070		7116.03.01.0000	4003474251073	230		9193.03.01.0000	4003474280738	047
025	8025.01.06.0000	4003474287652	145		7116.03.06.0000	4003474251080	230		9193.03.01.0000	4003474280738	176
	8025.01.10.0000	4003474287669	145		8116.01.01.0000	4003474251097	159		9193.06.01.0000	4003474281124	046
	8025.01.70.0000	4003474287676	145		8116.01.01.0000	4003474251097	233		9193.06.01.0000	4003474281124	177
028	3028.01.64.0000	4003474282978	154		8116.01.06.0000	4003474251110	159	195	4195.01.01.0000	4003474289205	213
	8028.01.64.0000	4003474282961	154		8116.01.06.0000	4003474251110	233		7195.02.01.0000	4003474289212	212
030	9030.01.64.0300	4003474286693	186		9116.06.01.0000	4003474251134	230		9195.04.01.0000	4003474283746	171
	9030.01.64.0400	4003474286709	186		9116.06.06.0000	4003474251141	231		9195.04.01.0000	4003474283746	213
037	9037.06.01.0000	4003474286914	069	117	9117.01.54.0000	4003474291031	038		9195.04.01.0500	4003474289229	212
041	8041.02.64.0010	4003474214993	148		9117.01.54.0000	4003474291031	168		9195.06.01.0000	4003474281599	171
060	9060.06.01.0000	4003474283272	047	120	6120.01.54.0000	4003474291048	118		9195.06.01.0000	4003474281599	213
	9060.06.01.0000	4003474283272	177	128	3128.02.09.0000	4003474169484	113		9195.06.01.0500	4003474289236	212
067	9067.06.64.0000	4003474291000	169		4128.01.09.0000	4003474168647	112	197	9197.05.64.0000	4003474281148	170
	9067.08.64.0000	4003474291024	169		5128.03.09.0000	4003474168654	112		9197.09.64.0000	4003474281155	170
076	4076.01.01.0000	4003474248523	239		6128.01.09.0000	4003474168661	112	204	7204.03.64.0000	4003474140155	138
	7076.02.01.0000	4003474248530	239		7128.02.09.0000	4003474168432	112		7204.04.64.0000	4003474140162	138
	9076.03.01.0000	4003474248547	239	141	6141.01.64.0000	4003474169200	110		7204.05.64.0000	4003474140179	138
	9076.04.01.0000	4003474248554	239	172	4172.01.06.0000	4003474206424	200	213	9213.05.01.0000	4003474246925	015
096	4096.01.64.0000	4003474126111	197		4172.02.06.0000	4003474206417	200	216	4216.01.01.0000	4003474110004	172
102	9102.05.01.0000	4003474280691	180	175	7175.05.01.0000	4003474282879	038		7216.02.01.0000	4003474289762	172
	9102.09.01.0000	4003474283876	180		7175.07.01.0000	4003474282886	039		9216.04.01.0000	4003474289793	172
104	6104.01.32.0506	4003474236568	136		9175.04.01.0000	4003474286396	039	218	4218.01.64.0000	4003474246598	243
	6104.01.64.0506	4003474235585	136		9175.09.01.0000	4003474286402	039		7218.02.64.0000	4003474246604	243
111	8111.02.32.0510	4003474236285	149	178	4178.01.01.1000	4003474260204	234		7218.03.64.0000	4003474246611	243

Serie Series	Art-Nr. Item-No.	EAN-Nummer EAN-Number	Seite Page	Serie Series	Art-Nr. Item-No.	EAN-Nummer EAN-Number	Seite Page	Serie Series	Art-Nr. Item-No.	EAN-Nummer EAN-Number	Seite Page
218	7218.04.64.0000	4003474246628	243	276	9276.01.01.1200	4003474280929	189	354	9354.03.64.0000	4003474183404	236
	9218.06.64.0000	4003474246635	243		9276.01.01.1300	4003474280943	189		9354.04.32.1000	4003474206998	238
225	4225.02.01.0000	4003474219493	017	277	3277.06.22.0000	4003474291246	052		9354.04.64.0000	4003474182810	237
	5225.05.01.0000	4003474209609	017		3277.06.64.0000	4003474290041	052		9354.06.64.0000	4003474182827	237
	5225.08.01.0000	4003474207117	016		6277.05.22.0000	4003474291055	053	360	4360.06.01.0000	4003474231969	106
234	3234.01.01.0000	4003474255002	037		6277.05.64.0000	4003474290034	053		7360.04.01.0000	4003474240558	106
	4234.01.01.0000	4003474280790	037	298	7298.03.64.0000	4003474167619	137		7360.07.01.0000	4003474240510	106
	7234.01.01.0000	4003474280783	037	301	3301.01.64.0000	4003474241715	218		9360.04.01.0000	4003474231884	105
	8234.01.01.0000	4003474280806	036		4301.01.64.0000	4003474235516	219		9360.06.01.0000	4003474231433	107
236	4236.01.64.0000	4003474227108	197		7301.02.64.0000	4003474235660	218		9360.09.01.0000	4003474231419	107
240	3240.05.01.0000	4003474272931	101		7301.04.64.0000	4003474235684	219		9360.16.01.0000	4003474231440	105
	6240.01.01.0000	4003474271040	099		8301.01.64.0000	4003474239644	218	361	3361.01.09.0000	4003474281315	160
	8240.01.01.0010	4003474272948	101		9301.06.64.0000	4003474235707	219		3361.01.64.0000	4003474281308	160
	8240.01.01.0200	4003474273679	101	306	3306.05.01.0000	4003474243054	103		3361.02.09.0000	4003474281339	160
	9240.04.01.0000	4003474271132	100		4306.02.01.0000	4003474242507	104		3361.02.64.0000	4003474281322	160
	9240.06.01.0000	4003474271118	100		7306.08.01.0000	4003474243283	104		4361.01.09.0000	4003474281346	226
	9240.07.01.0000	4003474271101	100		8306.01.01.0000	4003474243108	102		4361.01.64.0000	4003474281353	227
	9240.08.01.0000	4003474271125	100		8306.03.01.0000	4003474243290	103		7361.02.09.0000	4003474281360	226
248	6248.01.64.0200	4003474128733	139		9306.03.01.0000	4003474243061	103		7361.02.64.0000	4003474281377	227
	6248.01.64.0200	4003474128733	147		9306.04.01.0000	4003474243078	103		9361.04.09.0000	4003474281391	226
	6248.01.64.0250	4003474128740	139		9306.06.01.0000	4003474242477	104		9361.04.64.0000	4003474281407	227
	6248.01.64.0250	4003474128740	147		9306.12.01.0000	4003474191560	102		9361.06.09.0000	4003474281414	226
	6248.01.64.0300	4003474128757	139	308	8308.01.06.0300	4003474179186	248		9361.06.64.0000	4003474281421	227
	6248.01.64.0300	4003474128757	147		8308.01.06.0300	4003474179186	249	366	3366.01.64.0000	4003474274225	060
	6248.01.64.0350	4003474131450	139		8308.01.06.0400	4003474179193	248		4366.01.64.0000	4003474274249	060
	6248.01.64.0350	4003474131450	147		8308.01.06.0400	4003474179193	249		7366.01.64.0000	4003474274256	060
	8248.01.06.0200	4003474128474	146		8308.01.06.0500	4003474179209	248		8366.01.64.0000	4003474274263	060
	8248.01.06.0250	4003474128481	146		8308.01.06.0500	4003474179209	249	369	9369.01.01.0000	4003474286839	073
	8248.01.06.0300	4003474128498	146	313	3313.01.01.0000	4003474268545	061	377	4377.01.64.0000	4003474273327	228
	8248.01.06.4200	4003474228068	146		4313.01.01.0000	4003474268552	061		7377.02.64.0000	4003474273334	228
254	4254.01.64.0000	4003474132662	217		7313.01.01.0000	4003474268569	061		9377.03.64.0000	4003474273358	228
	4254.01.64.0500	4003474281933	216		8313.01.01.0000	4003474268576	061		9377.04.64.0000	4003474273341	228
	7254.02.64.0000	4003474128566	217	317	3317.02.64.0000	4003474281100	163		9377.06.64.0000	4003474273365	228
	7254.03.64.1000	4003474281940	121	327	4327.04.01.0000	4003474263588	096	378	7378.04.64.0000	4003474273990	116
	7254.05.64.0000	4003474281957	121		5327.24.01.0000	4003474257341	097	379	3379.01.01.0000	4003474265896	054
	9254.04.64.0000	4003474281926	216		8327.03.01.0000	4003474257396	096		3379.02.54.0000	4003474273914	054
	9254.06.64.0000	4003474283753	216		9327.08.01.0750	4003474262772	097		7379.05.01.0000	4003474264134	055
270	7270.04.64.0000	4003474268804	126		9327.20.01.0000	4003474257372	097		8379.01.01.0000	4003474265889	054
	7270.06.64.0000	4003474272733	126	330	3330.02.32.0000	4003474287270	162	389	3389.02.02.3000	4003474169569	164
272	9272.04.01.0000	4003474281964	174		3330.02.54.0000	4003474287287	162		3389.02.09.3000	4003474169729	164
	9272.09.01.0000	4003474281971	174	343	8343.01.64.0000	4003474207490	152		3389.02.64.0000	4003474168265	164
273	6273.01.70.1200	4003474245324	110	350	9350.01.64.0000	4003474263533	183	393	4393.01.64.0000	4003474231723	235
275	3275.01.64.0000	4003474281506	043		9350.01.64.0400	4003474263854	183		7393.02.64.0000	4003474231730	235
	4275.01.64.0000	4003474281513	043	354	4354.01.32.1000	4003474206943	238		7393.04.64.0000	4003474231747	235
	7275.01.64.0000	4003474281520	044		4354.01.32.1500	4003474206950	238	399	7399.04.64.0000	4003474180830	137
	8275.01.64.0000	4003474281544	043		4354.01.64.0000	4003474182780	237		7399.06.64.0000	4003474192932	137
	9275.03.64.0000	4003474290614	045		4354.01.64.0500	4003474183381	237	416	9416.08.01.0000	4003474286099	068
	9275.05.64.0000	4003474290621	045		7354.02.32.1000	4003474206967	238	419	9419.02.64.0280	4003474182452	199
276	9276.01.01.0200	4003474280820	188		7354.02.64.0000	4003474182797	236		9419.04.64.0400	4003474182469	199
	9276.01.01.0300	4003474280844	188		7354.03.64.0000	4003474182803	236	420	7420.04.64.0000	4003474281865	117

INDEX

INDEX

Serie Series	Art-Nr. Item-No.	EAN-Nummer EAN-Number	Seite Page	Serie Series	Art-Nr. Item-No.	EAN-Nummer EAN-Number	Seite Page	Serie Series	Art-Nr. Item-No.	EAN-Nummer EAN-Number	Seite Page
423	8423 .01.06.0000	4003474270418	144	488	7488 .05.64.0100	4003474170930	130	596	7596 .06.64.0000	4003474235509	125
	8423 .01.10.0000	4003474289564	144	494	6494 .01.01.0000	4003474259550	111	604	4604 .04.01.0000	4003474271033	098
425	4425 .01.01.0000	4003474261072	194		8494 .01.01.0010	4003474259536	111		9604 .06.01.0000	4003474269207	098
	4425 .01.06.0000	4003474261065	194	505	3505 .01.24.0000	4003474287188	028		9604 .10.01.0000	4003474271767	098
427	8427 .01.06.0000	4003474289571	144		3505 .01.34.0000	4003474287171	028	613	3613 .01.64.0000	4003474268774	058
432	4432 .02.64.0000	4003474168760	201		3505 .01.54.0000	4003474287164	030		7613 .03.64.0000	4003474111186	059
435	7435 .05.54.0000	4003474274164	123		8505 .01.24.0000	4003474287195	028		7613 .04.64.0000	4003474268781	058
	7435 .08.54.0000	4003474274171	123		8505 .01.34.0000	4003474287201	029		8613 .01.64.0000	4003474268798	058
446	9446 .05.01.0000	4003474257068	019		8505 .01.54.0000	4003474287218	031	615	7615 .05.64.0000	4003474281711	229
449	3449 .01.01.0000	4003474259703	109		9505 .01.24.0000	4003474287225	029		9615 .07.64.0000	4003474281728	229
	6449 .01.01.0250	4003474261935	109		9505 .01.34.0000	4003474287232	029		9615 .09.64.0000	4003474281735	229
	6449 .01.01.0350	4003474261928	108		9505 .01.54.0000	4003474287249	031	619	7619 .04.01.0000	4003474249094	120
	8449 .01.01.0000	4003474259277	109	511	4511 .01.01.0000	4003474272337	181		7619 .06.01.1000	4003474262475	120
450	3450 .01.32.0000	4003474273518	087		4511 .02.01.0000	4003474272320	181	624	9624 .05.01.0320	4003474290379	174
	3450 .01.64.0000	4003474271606	084	535	4535 .01.32.0000	4003474273563	224	625	3625 .01.01.0000	4003474280615	033
	6450 .01.32.0250	4003474273693	087		4535 .01.64.0000	4003474270678	222		4625 .01.01.0000	4003474004211	033
	6450 .01.64.0250	4003474273686	085		7535 .02.32.0000	4003474273570	224		7625 .01.01.0000	4003474280608	032
	7450 .02.32.0000	4003474273525	087		7535 .02.64.0000	4003474270685	222		8625 .01.01.0000	4003474280622	033
	7450 .02.64.0000	4003474270593	085		7535 .04.32.0000	4003474273594	224		9625 .01.01.0000	4003474285856	033
	7450 .03.32.0000	4003474273532	086		7535 .04.64.0000	4003474270708	222	629	7629 .02.64.0000	4003474260341	214
	7450 .03.64.0000	4003474270586	085		7535 .05.32.0000	4003474273600	122		7629 .04.64.0000	4003474260358	214
	7450 .04.64.0000	4003474270579	084		7535 .05.64.0000	4003474270722	122		4629 .01.64.0000	4003474260334	215
	8450 .01.32.0000	4003474273648	086		9535 .06.32.0000	4003474273617	225	631	4631 .01.64.0000	4003474173580	242
	8450 .01.32.0250	4003474273549	086		9535 .06.64.0000	4003474270715	223		4631 .01.64.0500	4003474173597	242
	8450 .01.64.0000	4003474271613	084	543	9543 .01.01.0000	4003474279473	067		7631 .02.64.0000	4003474173603	242
	8450 .01.64.0250	4003474272658	084	547	9547 .01.64.0300	4003474284408	187	637	9637 .01.64.0210	4003474168821	199
451	4451 .01.64.0000	4003474207155	201		9547 .01.64.0400	4003474284415	187	641	4641 .01.01.0000	4003474269290	198
	4451 .01.64.0500	4003474218724	201	557	3557 .01.01.0450	4003474281889	065		7641 .02.01.0000	4003474269306	198
453	3453 .03.32.0000	4003474291475	093		3557 .01.01.0850	4003474281896	065	662	9662 .01.06.0510	4003474287829	182
	3453 .03.54.0000	4003474289946	091		3557 .01.01.1100	4003474281902	064		9662 .01.06.0680	4003474287812	182
	4453 .03.32.0000	4003474291482	093		3557 .05.01.0000	4003474279480	064	664	3664 .03.64.0000	4003474229263	088
	4453 .03.54.0000	4003474289885	091		9557 .08.01.0000	4003474291192	066		6664 .01.64.0000	4003474201368	089
	5453 .06.32.0000	4003474291499	092		9557 .10.01.0000	4003474283197	065		7664 .02.64.0000	4003474201405	088
	5453 .06.54.0000	4003474289953	090		9557 .16.01.0000	4003474283203	066		7664 .04.64.0000	4003474201443	088
	8453 .01.32.0000	4003474291505	093	568	3568 .03.01.0000	4003474242705	025		8664 .01.64.0500	4003474254333	089
	8453 .01.54.0000	4003474289915	091		4568 .01.01.0220	4003474246260	023		8664 .03.64.0000	4003474228525	089
	8453 .03.32.0000	4003474291512	092		4568 .01.01.1000	4003474257655	025	669	4669 .01.64.0000	4003474155920	245
	8453 .03.54.0000	4003474289922	090		6568 .01.01.0350	4003474242712	021		4669 .01.64.0500	4003474155937	245
	9453 .06.32.0000	4003474291529	092		7568 .02.01.1000	4003474257662	025		7669 .02.64.0000	4003474155944	244
	9453 .06.54.0000	4003474289960	090		7568 .03.01.0200	4003474242729	020		7669 .03.64.0000	4003474155951	244
468	3468 .01.32.0000	4003474285924	155		7568 .04.01.0000	4003474245744	022		7669 .04.64.0000	4003474155968	244
	3468 .01.64.0000	4003474271798	155		8568 .01.01.0130	4003474245782	021		9669 .04.64.0000	4003474146409	245
	8468 .01.32.0000	4003474069524	155		8568 .02.01.0000	4003474245720	023		9669 .06.64.0000	4003474150147	244
	8468 .01.64.0000	4003474271804	155		9568 .01.01.0350	4003474242743	021	671	9671 .01.06.0000	4003474287102	173
471	8471 .01.10.0000	4003474289601	144		9568 .03.01.0250	4003474259123	024		9671 .01.06.0500	4003474287119	173
472	8472 .01.06.0000	4003474290386	144		9568 .06.01.0000	4003474245768	023	679	4679 .01.01.0000	4003474253664	196
475	4475 .01.01.0000	4003474277714	175	581	4581 .02.01.0000	4003474260259	195		4679 .01.63.0000	4003474253671	196
	7475 .02.01.0000	4003474277721	175		4581 .02.06.0000	4003474259376	195	682	3682 .01.01.0000	4003474259598	049
	9475 .04.01.0000	4003474277738	175		4581 .02.64.0000	4003474259352	195		3682 .01.01.0500	4003474264493	048
479	6479 .06.01.0000	4003474257075	019	596	7596 .04.64.0000	4003474235639	125		3682 .01.64.0000	4003474279213	050

Serie Series	Art-Nr. Item-No.	EAN-Nummer EAN-Number	Seite Page	Serie Series	Art-Nr. Item-No.	EAN-Nummer EAN-Number	Seite Page	Serie Series	Art-Nr. Item-No.	EAN-Nummer EAN-Number	Seite Page
682	3682.01.64.0500	4003474279206	051	825	4825.01.54.0000	4003474274133	041	946	4946.04.01.0000	4003474283067	062
	4682.01.01.0000	4003474259567	049		7825.01.54.0000	4003474274140	040		8946.01.01.0000	4003474283050	063
	7682.01.64.0500	4003474279220	051		7825.01.54.1000	4003474291208	042		9946.08.01.0000	4003474283074	062
	7682.01.64.1200	4003474289496	051		8825.01.54.0000	4003474274157	040	960	4960.01.01.0000	4003474263403	074
	8682.01.01.0000	4003474259604	049		9825.01.54.0000	4003474274560	041		8960.01.01.0300	4003474261188	074
	8682.01.64.0000	4003474279855	050	831	7831.04.01.0000	4003474274201	076		8960.01.01.0500	4003474261195	075
687	8687.01.64.0260	4003474197333	148		9831.04.01.0000	4003474269177	077	970	7970.04.22.0000	4003474290997	119
693	9693.01.70.0300	4003474265629	185		9831.06.01.0000	4003474269184	076		7970.04.64.0000	4003474290645	119
	9693.01.70.0600	4003474265636	185	840	3840.01.64.0000	4003474156842	161	973	9973.05.32.0000	4003474291123	094
	9693.01.70.1200	4003474265643	184		3840.02.64.0000	4003474156859	161		9973.05.64.0000	4003474283661	095
	9693.01.70.5200	4003474286235	185	848	4848.01.54.0000	4003474289694	178		9973.09.32.0000	4003474291130	094
	9693.01.70.5300	4003474286211	185		7848.03.54.0000	4003474138046	178		9973.09.64.0000	4003474283678	095
	9693.01.70.5600	4003474286228	185		9848.05.54.0000	4003474289700	179	988	7988.04.01.0100	4003474251660	127
720	4720.01.64.0000	4003474151960	190		9848.06.54.0000	4003474289724	178	997	3997.01.32.0000	4003474292588	078
722	6722.01.64.0006	4003474209173	133	849	4849.01.64.0000	4003474167978	240		3997.01.64.0000	4003474291550	078
	7722.02.64.0006	4003474209203	133		4849.01.64.0500	4003474167985	240		6997.01.32.0000	4003474292595	079
	7722.03.64.0006	4003474209234	132		7849.02.64.0000	4003474167992	240		6997.01.64.0000	4003474291574	079
	8722.01.64.0006	4003474228334	148		7849.03.64.0000	4003474168005	241		7997.01.32.0000	4003474292601	080
744	6744.01.64.0000	4003474183220	135		7849.04.64.0000	4003474168067	241		7997.01.64.0000	4003474292236	080
	7744.02.64.0000	4003474183237	135		9849.03.64.0000	4003474168029	240		8997.01.32.0000	4003474292618	081
	7744.03.64.0000	4003474195698	134		9849.06.64.0000	4003474168036	240		8997.01.64.0000	4003474291635	081
747	8747.02.01.0000	4003474196268	150	865	8865.02.32.0000	4003474156361	151		9997.01.32.0000	4003474292625	083
	8747.02.32.0000	4003474193823	150		8865.02.64.0000	4003474156378	151		9997.01.64.0000	4003474291673	082
	8747.02.64.0000	4003474179568	150	886	7886.05.64.0000	4003474237251	124	4111		4003474164281	078
759	9759.08.01.0000	4003474286907	069	888	3888.01.64.0000	4003474293400	035	4113		4003474291727	078
760	8760.01.01.0300	4003474271620	014		4888.01.64.0000	4003474293417	035	4114		4003474291734	079
	8760.01.01.0500	4003474271637	014		7888.01.64.0000	4003474293424	034	4116		4003474291758	079
792	7792.06.54.0500	4003474289816	207		8888.01.64.0000	4003474293431	035	4117		4003474291765	080
	9792.06.01.0000	4003474289342	208		9888.01.64.0000	4003474293448	035	4119		4003474291789	080
	9792.06.01.0300	4003474289373	209	889	3889.01.64.0000	4003474282749	056	4120		4003474291796	081
	9792.06.54.0500	4003474289823	207		4889.01.64.0000	4003474177960	056	4122		4003474291819	081
	9792.08.01.0000	4003474289397	208		7889.04.64.0000	4003474198170	057	4123		4003474291826	083
	9792.08.54.0500	4003474289847	206		8889.01.64.0000	4003474282732	056	4125		4003474097053	083
	9792.10.01.0000	4003474289410	209		9889.01.64.0000	4003474291215	057	4126		4003474291840	078
796	4796.01.32.0000	4003474282466	220		9889.04.64.0000	4003474178004	057	4127		4003474291857	079
	4796.01.64.0000	4003474282473	221	894	7894.04.64.0106	4003474212791	129	4128		4003474291864	080
	7796.02.32.0000	4003474282480	220	895	7895.04.64.0106	4003474212623	129	4129		4003474291871	081
	7796.02.64.0000	4003474282497	221	897	7897.04.64.0100	4003474162287	131	4130		4003474213712	083
	9796.04.32.0000	4003474282503	220		7897.06.64.0100	4003474162294	131	4131		4003474213729	083
	9796.04.64.0000	4003474282510	221	906	3906.01.01.0000	4003474243566	152	4132		4003474213743	083
	9796.06.32.0000	4003474282527	220	909	3909.01.01.0000	4003474244044	153	4134		4003474291888	083
	9796.06.64.0000	4003474282534	221		8909.01.01.0000	4003474243719	153	4136		4003474292274	081
804	6804.01.64.0000	4003474152752	110	922	6922.03.01.0000	4003474289304	072	4138		4003474292359	079
806	4806.01.01.0000	4003474034843	211		8922.01.01.0350	4003474282824	072	4140		4003474292380	080
	7806.02.01.0000	4003474034881	210	923	7923.04.64.0000	4003474207261	128	4142		4003474292403	078
	7806.03.01.0000	4003474269894	210	928	4928.01.64.0000	4003474156934	200	4143		4003474292458	083
	7806.05.01.0000	4003474274072	046	931	4931.02.64.0000	4003474158440	200	4144		4003474292465	083
	9806.04.01.0000	4003474040240	210	942	7942.04.64.0100	4003474183510	130				
807	3807.03.64.0000	4003474281650	163	946	3946.01.01.0000	4003474283043	063				
825	3825.01.54.0000	4003474274126	040		4946.03.01.0000	4003474282985	062				

SERIENVERZEICHNIS

SERIES INDEX

Serie Series	Name Name	Serie Series	Name Name	Serie Series	Name Name
022	ALBERO	664	GEORGIA	187	PARC
840	ALI	471	GERIT	988	PARKER
330	ANGERS	435	GESS	248	POINT
354	ANGOLA	604	HARPER	865	POP
615	ANISSA	568	HOLLY	747	PRESCOT
792	ANTIBES	619	INTERIO	432	PRINCE
366	APART	662	JADEN	116	QUINCY
451	AQABA	028	JET	116	QUINCY
306	ARC	419	KANPUR	272	REIMS
225	ARIZONA	060	KENT	120	ROMA
360	ASTRO	128	LACCHINO	671	RONDO
886	ATLANTA	889	LAURIDS	744	SACRAMENTO
104	AUGUSTA	369	LAVAL	399	SANTA FEE
759	AURORA	511	LEDA	722	SAVANNAH
270	AVA	378	LENOX	327	SIENNA
831	AVANCE	720	LESS	350	SILA
298	AVANTI	024	LEX	389	SKIN
275	AVIGNON	693	LIV	631	SLEEVE-VETRO
557	BENETT	343	LIVERPOOL	117	SOUL
581	BRAEZ	175	LOGAN	216	SPACE
111	BRISTOL	624	LORE	102	SPHINX
928	BUDDY	848	LORIENT	922	STYLE
423	CAJA	468	LOU	596	TALAS
796	CAMERON	825	LOUVRE	488	TEEN
906	CAMPUS	308	LUA	629	TEXEL
535	CARA	641	LUV	997	TOULOUSE
453	CASA	909	LUX	973	TROJA
760	CHARME	682	LUZ	427	TROND
494	CHATEAU	806	MAAR	194	TUVA
195	CHLOE	942	MADISON	006	TWIN
197	CHOLET	204	MALI	625	VANNES
804	CLARA	076	MARCO	807	VANT
505	CLARC	446	MARQUIS	543	VELA
450	CLASS	301	MAURO	096	VELO
234	COLMAR	041	MAXIME	240	VERRE
377	COLO	313	MERCUR	236	VETRO
894	COLUMBIA	849	MICKEY	679	VIA
888	COMTE	193	MIDU	254	VILETA
970	CONTES	030	MILE	317	VITRO
960	COSMO	687	MINSTER	379	VOSS
416	CRUX	475	MIRA	037	XENIA
613	DARWIN	273	MODENA	025	YON
213	DELUXE	547	MODO	172	ZIBO
449	DEVENTER	479	MOULIN	192	ZOON
897	DIA	276	NANCY		
425	DIVINA	895	NASHVILLE		
931	EDDY	277	NERO		
007	ETANA	112	NEWTON		
361	EVE	178	NICE		
067	EVERETT	669	NINI		
420	EVRY	218	NIXON		
637	FIGO	393	NOA		
472	FIN	923	OKLAHOMA		
141	FLAME	946	ORBIT		



01	Chrom	Chrome	chrome	Cromo	chrom	хромированный
02	Messing-gefärbt	Coloured brass	imitation laiton	Latón-teñido	mosiądz zafarbowany	цветная латунь
03	Bronze	Bronze	bronze	Bronce	brąz	бронзовый
06	Weiß	White	blanc	Blanco	biały	белый
09	Antik braun	Antique brown	antique brune	Color tostado	rdzawy	под ржавчину
10	Schwarz	Black	noir	Negro	czarny	чёрный
13	Gold-farbig	Gold coloured	or coloré	Dorado	złoty	бежевый
16	Gelb	Yellow	jaune	Amarillo	żółty	жёлтый
22	Messing modern	Brass modern	laiton massif	latón moderno	mosiądz modny	современная латунь
24	Schwarz/Chrom	Black/Chrome	noir/chrome	Negro/Cromo	czarny/chrom	чёрный/ хромированный
32	Messing-matt	Brass matt finished	laiton mat	Latón-mate	mosiądz matowy	матовая латунь
34	Weiß/Chrom	White/Chrome	blanc/chrome	Blanco/Cromo	biały/chrom	белый/ хромированный
54	Nickel-matt/Chrom	Nickel matt finished/ Chrome	Nickel mat/ chrome	Níquel-mate/cromo	stal matowa/chrom	матовое железо/ хром
63	Aluminium gebürstet	aluminium brass finished	en couleur nickel	Aluminio satinado	aluminium	матовый алюминий
64	Nickel-matt	Nickel matt finished	Nickel mat	Níquel-mate	stal matowa	матовое железо
70	Silber	Silver	argent	Plata	srebrny	серебряный
77	Perlgrau gewischt	wiped pearl grey	gris perle brossé	gris perla	perłowo-szary szczotkowany	жемчужно-серый
92	Creme rustikal	Creme rustic	Crème rustique	crema	kremowy rustykalny	кремовый

Gerne begrüßen wir Sie in unserem Showroom

Pleased to meet you in our showroom

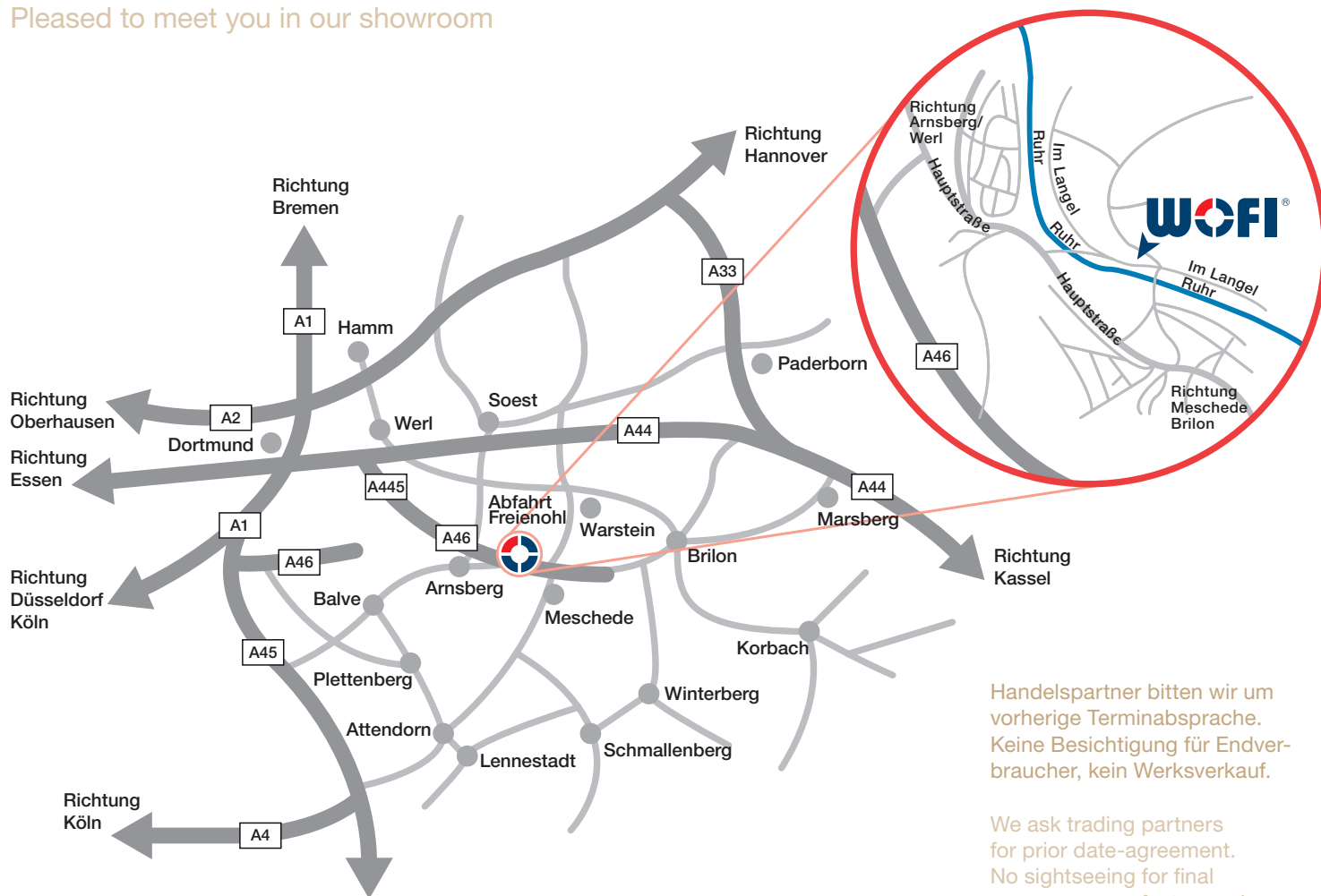

Handelspartner bitten wir um vorherige Terminabsprache. Keine Besichtigung für Endverbraucher, kein Werksverkauf.

We ask trading partners for prior date-agreement. No sightseeing for final consumers, no factory-sale.

Oder besuchen Sie unsere Internetseite unter www.wofi.de

Or visit our website under www.wofi.de

Vertriebskontakt / Sales Contact

Möchten Sie den Vertriebsinnendienst erreichen verwenden Sie bitte die bekannte Durchwahl.

If you would like to get hold of the Sales Department please dial the known extension.

**Service / Service
WOFI-Kundendienst**

Postfach 3271
D - 59861 Meschede-Freienohl

phone +49 (0) 2903 449 449
fax +49 (0) 2903 449 459

email kundendienst@wofi.de
web www.wofi.de

Zentrale / Phone reception

Wortmann & Filz GmbH

Im Langel 6
D - 59872 Meschede-Freienohl

phone +49 (0) 2903 449 0
fax +49 (0) 2903 449 114

email info@wofi.de
web www.wofi.de



WOFI Verwaltung









WOFI Logistik-Zentrum

Zeichenerklärung

...signs & symbols

					
Technische Beschreibung	Technical Description	Description Technique	Descripción Tecnica	Opis techniczny	Техническое описание
 Durchmesser	Diameter	diamètre	diámetro	średnica	диаметр
 Höhe	Height	hauteur	Altura	wysokość	высота
 Breite	Width	largeur	anchura	szerokość	ширина
 Länge	Length	longueur	Longitud	długość	длина
 Ausladung	Outreach	portée	Alcance	zasiąg	зона Досягаемости
 Stufenlos höhenverstellbar	Height infinitely adjustable	hauteur réglable sans cran	adjustable en altura sin	bezpstopniowe przestawianie wysokości	бесступенчатая регулировка по высоте
 Individuell kürzbar	Can be shortened as required	Raccourcissement individuel	acortable de manera individual	możliwość indywidualnego skrócenia	индивидуально укорачиваемая
 Handdimmer	Hand dimmer	variateur manuel	Reductor de luz de mano	ręczny regulator jasności światła	ручной регулятор яркости
 Fußdimmer	Foot dimmer	variateur à pied	Reductor de luz de pie	nożny regulator jasności światła	педаль регулятора яркости
 Ober- und Unterlicht	Upper and lower light	Lumière inférieure et supérieure	Luz superior e inferior	światło górne i dolne	верхний и нижний свет
 LED	LED	LED	Diodo luminoso	Dioda elektroluminescencyjna (DEL)	светодиодный индикатор
 Schalter	Switch	interrupteur	interruptor	z włącznikiem	с выключателем
 Schwenkbar	Swivelling	orientable	girable	wysuwana	с возможностью перемещения
 Touch-It	Touch-It	Touch-It	Touch-It	Touch-It	сенсор
 Fernbedienung	Remote control	télécommande	mando a distancia	pilot	пульт управления

	Glühlampen Sockel E27	Incandescent Bulb E27 base	Ampoules douille E27	Bombillas base E27	Żarówki Cokół E27	лампь накаливания цоколь E27
	Allgebrauchslampe	General lighting service lamp	Ampoule multi-usage	Lámpara de uso universal	Żarówka do ogólnego użytku	лампа универсального применения
	Globelampe	Globe lamp	Ampoule à globe	Lámpara en forma de globo	Żarówka w formie kuli	шарообразная лампа
	Reflektorlampe R63	R63 reflector lamp	Ampoule à réflecteur R63	Lámpara de reflector R63	Żarówka projektorowa R63	рефлекторная лампа R63
	Reflektorlampe PAR 20/30	PAR 20/30 reflector lamp	Ampoule à réflecteur PAR 20/30	Lámpara de reflector PAR 20/30	Żarówka projektorowa PAR 20/30	рефлекторная лампа PAR 20/30
	Glühlampen Sockel E14	Incandescent Bulb E14 base	Ampoules douille E14	Bombillas base E14	Żarówki Cokół E14	лампа накаливания цоколь E14
	Kerzenlampe	Candle lamp	Ampoule bougie	Lámpara en forma de vela	Żarówka w formie Świecy	лампа в фовме свечи
	Tropfenlampe Globelampe Ø 45mm	Round bulb lamp / Globe lamp Ø 45mm	Ampoule goutte / ampoule à globe Ø 45mm	Lámpara en forma de gota / Lámpara en forma de globo Ø 45mm	Żarówka w formie kropli / Żarówka w formie kuli Ø 45mm	каплеобразная лампа/ круглая лампа Ø 45mm
	Reflektorlampe R50	R50 reflector lamp	Ampoule à réflecteur R50	Lámpara de reflector R50	Żarówka projektorowa R50	рефлекторная лампа R50



WOFI Designs sind grundsätzlich als Geschmacksmuster geschützt. Nachahmungen werden gerichtlich verfolgt.
WOFI Designs are strictly protected as design patent. Imitations will be prosecuted.

lichtforumnrw



Alle Leuchten, die mit diesem Symbol gekennzeichnet sind, werden inkl. einem energieeffizienten ECO-Markenleuchtmittel geliefert.

All lighting fixtures marked with this symbol will be delivered with a energy-efficient ECO illuminant.



Alle Leuchten, die mit diesem Symbol gekennzeichnet sind, werden inkl. Energiesparleuchtmittel geliefert.

All lighting fixtures marked with this symbol will be delivered with energy saving lamps.

Alle Maßangaben in diesem Katalog sind ca. Angaben. Alle Maßangaben sind cm Angaben.
All measures in this catalogue are approximately. All measures are in cm.

					
Halogen Lampen Hochvolt	Halogen lamps high volt	Ampoule halogène haute-tension	Lámparas de halógeno alto voltaje	Lampy halogenowe wysokonapięciowa	галогенные лампы Высокое напряжение
 Halogenlampe in Röhrenform Sockel E14 / E27	Tube-shaped halogen lamp E14 / E27 base	Ampoule halogène en forme de tube, Douille E14 / E17	Lámpara de halógeno en forma de tubo, base E14 / E27	Żarówka halogenowa w formie rękowej, Cokół E14 / E27	трубчатая галогенная лампа цоколь E14/E27
 Stablampe 78 oder 118 mm lang, Sockel R7s	Electric torch 78 or 118 mm long, R7s base	Ampoule tige 78 ou 118 mm de long, Douille R7s	Lámpara cilíndrica 78 o 118 mm de largo, base R7s	Żarówka rurkowa 78 lub 118 mm długości, Cokół R7s	трубчатая лампа длиной 78 или 118 мм, цоколь R7s
 Reflektorlampe Ø 50 mm, mit aluminiumbeschichtetem Reflektor Sockel GU10 / GZ10	Reflector lamp Ø 50 mm, with aluminiumcoated reflector GU10 / GZ10 base	Ampoule de réflecteur Ø 50 mm, à réflecteur recouvert d'aluminium, Douille GU10 / GZ10	Lámpara de reflector Ø 50 mm, con reflector revestido de aluminio, base GU10 / GZ10	Żarówka projektorowa Ø 50 mm, z reflektorem o aluminiowej powłoce, Cokół GU10 / GZ10	рефлекторная лампа Ø 50mm, с рефлектором с алюминиевым покрытием, цоколь GU10/GZ10
 Halogenlampe „Halopin“ Sockel G9	„Halopin“ halogen lamp G9 base	Ampoule halogène „Halopin“ Douille G9	Lámpara de halógeno „Halopin“ base G9	Żarówka halogenowa „Halopin“ Cokół G9	галогенная лампа »Галопин« цоколь G9
 Halogenlampe „Decopin“ Sockel G9	„Decopin“ halogen lamp G9 base	Ampoule halogène „Decopin“ Douille G9	Lámpara de halógeno „Decopin“ base G9	Żarówka halogenowa „Decopin“ Cokół G9	галогенная лампа »деколайн« цоколь G9
Halogen Lampen Niedervolt	Halogen lamps low volt	Ampoule halogène basse-tension	Lámparas de halógeno bajo voltaje	Lampy halogenowe niskonapięciowa	галогенные лампы низкое напряжение
 Kaltlichtlampe Ø 50 mm, Sockel GU5,3	Cold light lamp Ø 50 mm, GU5,3 base	Ampoule à fluo-compacte Ø 50 mm, Douille GU5,3	Lámpara de luz fría Ø 50 mm, base GU5,3	Żarówka o chłodnym strumieniu światła, Ø 50 mm, Cokół GU5,3	люминесцентная лампа Ø 50 мм, цоколь GU5,3
 Kaltlichtlampe Ø 35 mm, Sockel GU4	Cold light lamp Ø 35 mm, GU4 base	Ampoule à fluo-compacte Ø 35 mm, Douille GU4	Lámpara de luz fría Ø 35 mm base GU4	Żarówka o chłodnym strumieniu światła Ø 35 mm, Cokół GU4	люминесцентная лампа Ø 35 мм, цоколь GU4
 Stiftsockellampe Sockel G4 / GY6,35	Pin base lamp G4 / GY6,35 base	Ampoule à douille tige, Douille G4 / GY6,35	Lámpara de base de espigas base G4 / GY6,35	Żarówka z cokołem półkowym Cokół G4 / GY6,35	лампа со штыревым цоколем цоколь G4/GY6,35
 Ministar Sockel GY6,35	Ministar GY6,35 base	Ministar Douille GY6,35	Ministar base GY6,35	Ministar Cokół GY6,35	мини стар цоколь GY6,35
LED	LED	LED	LED	LED	светодиодная лампа
 LED	LED	LED	LED	LED	светодиодная лампа
 Reflektorlampe Sockel GU10	Reflector lamp GU10 base	Ampoule à réflecteur Douille GU10	Lámpara de reflector Base GU10	Żarówka projektorowa Cokół GU10	рефлекторная лампа цоколь GU10
 Sockel E14/E27	GU E14/E27	Douille E14/E27	Base E14/E27	Cokół E14/E27	цоколь E14/E27
Energiesparende Leuchtstofflampen	Power saving fluorescent lamps	Ampoule économe	Lámparas fluorescentes de consumo reducido de energía	Żarówka fluorescencyjne oszczędzające energię	Энергосберегающие газосветные лампы
 Sockel G5 / G13	G5 / G13 base	Douille G5 / G13	Base G5 / G13	Cokół G5 / G13	цоколь G5 / G13
 Sockel G23 / G24	G23 / G24 base	Douille G23 / G24	Base G23 / G24	Cokół G23 / G24	цоколь G23 / G24
 Sockel 2G 11	2G 11 base	Douille 2G 11	Base 2G 11	Cokół 2G 11	цоколь 2G 11
 Sockel E14 / E27	E14 / E27 base	Douille E14 / E27	Base E14 / E27	Cokół E14 / E27	цоколь E14 / E27
 Sockel 2GX13	2GX13 base	Douille 2GX13	Base 2GX13	Cokół 2GX13	цоколь 2GX13
 Sockel GX53	GX53 base	Douille GX53	Base GX53	Cokół GX53	цоколь GX53
 Sockel E27	E27 base	Douille E27	Base E27	Cokół E27	цоколь E27
 Sockel GR10Q	GR10Q base	Douille GR10Q	Base GR10Q	Cokół GR10Q	цоколь GR10Q
 Reflektorlampe Sockel GU10	Reflector lamp GU10 base	Ampoule à réflecteur Douille GU10	Lámpara de reflector Base GU10	Żarówka projektorowa Cokół GU10	рефлекторная лампа цоколь GU10
 Sockel GU10	GU10 base	Douille GU10	Base GU10	Cokół GU10	цоколь GU10
 Elektronischer Transformator mit Softstart und integriertem Schutz vor Kurzschluss und Überlastung	Electronic transformer with softstart and integrated protection against short-circuit and overload	Transformateur électronique a enclenchement soft et système de protection intégré en cas de court-circuit et de surtension	Transformador electrónico de arranque suave y dispositivo de protección contra cortocircuito y sobrecarga integrado	Elektroniczny transformator z łagodnym startem i z wbudowaną ochroną przed spięciem i przeciążeniem	электронный трансформаторный стартер с интегрированной защитой от короткого замыкания и перегрузок

CE Unsere Produkte erfüllen die grundlegenden Sicherheitsanforderungen, die in den EU-Richtlinien definiert sind.
Our products fulfill the basic safety requirements that are defined in the EU regulations.



Unsere Produkte werden durch den TÜV Rheinland oder dem VDE Prüfinstitut in jährlich wiederkehrenden Werksprüfungen begutachtet.
Our products are examined by the TÜV Rheinland or the VDE Test Institute in an annual factory test.



*online
unter
wofi.de*

*info@
wofi.de*

WOFI[®]

Wortmann & Filz GmbH
Im Langel 6
D - 59872 Meschede-Freienohl

Mail info@wofi.de
Web www.wofi.de

