Produkty

Products

Vysvětlivky / Descriptions 012

uni.body 014

quadra corona 016
 silky 018

retro corona 020
 silky 022

zig zag 024

up corona 026

mystic meridia 028
 dione 030
 methis 032
 io 034

x-line zen 036
 color 038

ledissimo direct 040
 indirect 042

lotus 044

tube 046

mercur 048

infos 050













Vysvětlivky

Descriptions

Provedení/Finish

 .00 broušený nerez brushed stainless steel	 .05 černá black	 .10 žlutá yellow
 .01 leštěný nerez polished stainless steel	 .06 červená red	 .11 fialová purple
 .02 eloxovaný hliník anodized aluminium	 .07 zelená green	 .12 oranžová orange
 .03 RAL barva dle výběru RAL color of your choice	 .08 modrá blue	 .13 bílá/stříbrná white/silver
 .04 bílá white	 .09 růžová pink	 .14 bílá/zlatá white/gold



Vlastnosti/Features

 vestavné nástěnné wall mount	 LED zdroj LED light source
 vestavné stropní ceiling mount	 nutnost 12V trafo 12V transformer required
 přisazené nástěnné surface wall mount	 montáž do elektroinstalační krabice installation in an electrical box
 přisazené stropní surface ceiling mount	 elektronický předřadník electronic ballast
 závěsné, přímý zdroj suspended - direct lighting	 ochranná folie na kovovém povrchu protective foil on the metal surface
 závěsné, nepřímý zdroj suspended - indirect lighting	 patentovaný magnetický systém patented magnetic system
 závěsné, přímý & nepřímý zdroj suspended, direct & indirect lighting	

Volitelné/Optional

 stmívání dimming
 LED v provedení RGB LED in RGB version
 krytí proti vlhkosti IP44 IP44 moisture protection

Rozměry/Dimensions

 200	vnější část outer part
 200	vestavná část recessed part

uni.body

.....
Univerzální zápusné tělo uni.body tvoří jádro několika kolekcí. Pečlivě navržená konstrukce těla z lakovaného plechu umožňuje velmi jednoduchou instalaci a údržbu, v neposlední řadě pak poskytuje uživateli svobodu výběru. Pomocí patentovaného magnetického systému je totiž možné zápusné tělo osadit krytem z vybrané kolekce, případně si nechat vyrobit na zakázku tvar dle vlastního návrhu.

.....
The universal recessed uni.body is the heart of several collections. Carefully designed construction using lacquered sheet metal makes for easy installation and maintenance, and also gives the user freedom of choice. Using a patented magnetic system, it is possible to mount a cover from the collection of your choice over the recessed fixture, or possibly custom order one of your own design.

.....

uni.body

- 1
zarážky/stoppers
- 2
šrouby/screws
- 3
vymezovací trny/spacers

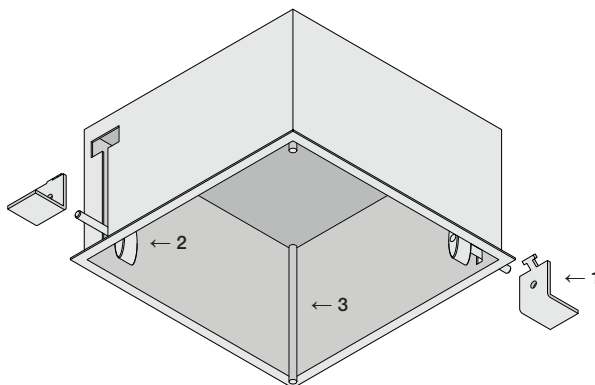

←
uni.body
150x150x90

.....

kompatibilní kolekce/compatible collections

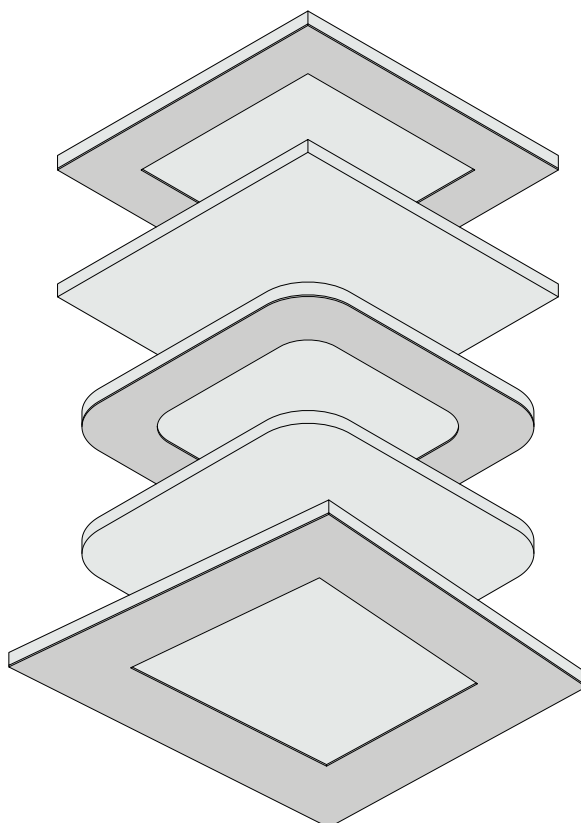

←
quadra
corona 18

←
quadra
silky 18

←
retro
corona 18

←
retro
silky 18

←
zig zag
22

quadra corona



quadra corona 95

quadra corona 50

quadra corona 30

quadra corona 18

quadra corona 14

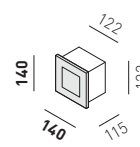
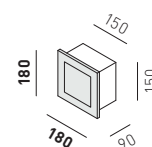
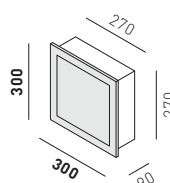
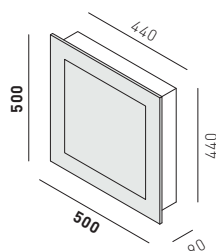
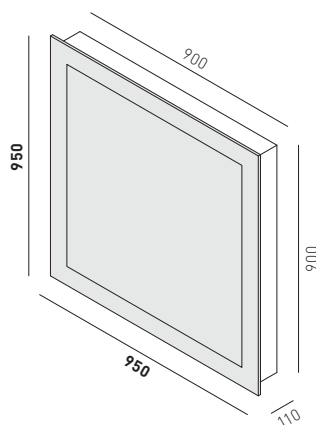
12095.00**12050.00****12030.00****12018.00****12014.00**výzbroj/equipment
4x 39 W T5 G5výzbroj/equipment
4x 36 W TC-L 2G11
8040 lm LEDvýzbroj/equipment
2x 24 W TC-F 2G10
2010 lm LEDvýzbroj/equipment
1x 18 W TC-F 2G10
2000 lm LEDvýzbroj/equipment
2x 15 W E27napětí/voltage
230 Vnapětí/voltage
230 Vnapětí/voltage
230 Vnapětí/voltage
230 Vnapětí/voltage
230 V

quadra corona 64

quadra corona 43

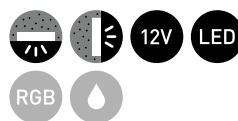

quadra LED corona 15

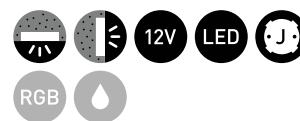

quadra LED corona 8

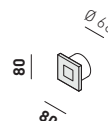
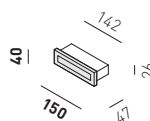
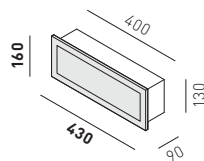
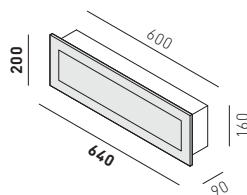
12064.00**12043.00****12015.00****12008.00**výzbroj/equipment
1x 55 W TC-L 2G11
4134 lm LEDvýzbroj/equipment
1x 24 W TC-L 2G11
2756 lm LEDvýzbroj/equipment
1,5 W LEDvýzbroj/equipment
1 W LEDnapětí/voltage
230 Vnapětí/voltage
230 Vnapětí/voltage
12 V DCnapětí/voltage
12 V DC

Provedení/Finish:

.00

.01

.02

Kolekce quadra corona využívá systému univerzálních vestavných těl uni.body a patentovaného magnetického uchycení krytu z akrylátového skla Perspex®. Měkké světlo vycházející zpod krycího rámečku vytváří působivý efekt korony.

The quadra corona collection uses a system of universal recessed uni.body fixtures and patented magnetic mounts for Perspex® acrylic glass covers. The soft light coming from under the cover frame creates an impressive corona effect.



quadra silky



quadra silky 50

14050.00

výzbroj/equipment
4x 36 W TC-L 2G11
8040 lm LED

napětí/voltage
230 V

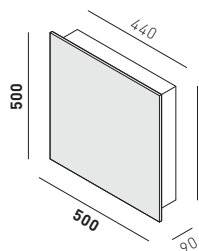

quadra silky 30

14030.00

výzbroj/equipment
2x 24 W TC-F 2G10
2010 lm LED

napětí/voltage
230 V

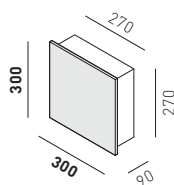

quadra silky 18

14018.00

výzbroj/equipment
1x 18 W TC-F 2G10
2000 lm LED

napětí/voltage
230 V

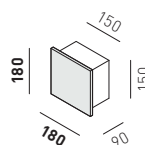

quadra silky 14

14014.00

výzbroj/equipment
2x 15 W E27

napětí/voltage
230 V

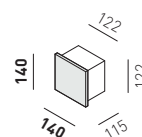

quadra silky 64

14064.00

výzbroj/equipment
1x 55 W TC-L 2G11
4134 lm LED

napětí/voltage
230 V

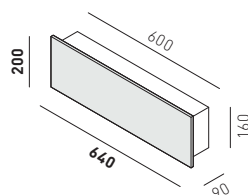

quadra silky 43

14043.00

výzbroj/equipment
1x 24 W TC-L 2G11
2756 lm LED

napětí/voltage
230 V

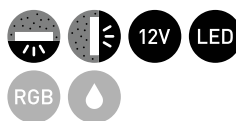
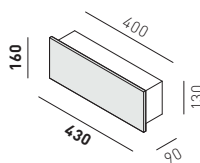

quadra LED silky 15

14015.00

výzbroj/equipment
1,5 W LED

napětí/voltage
12 V DC

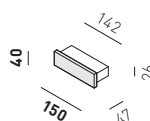

quadra LED silky 8

14008.00

výzbroj/equipment
1 W LED

napětí/voltage
12 V DC

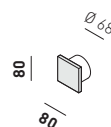

Magnetický kryt svítidel z matného akrylátového kolekce quadra silky není osazen viditelným kovovým rámečkem, vytváří tak minimalistickou alternativu ke kolekci quadra corona.

The magnetic fixture cover of the quadra silky collection is made of frosted acrylic and doesn't have any metal frame, thus creating a minimalist alternative to the quadra corona collection.

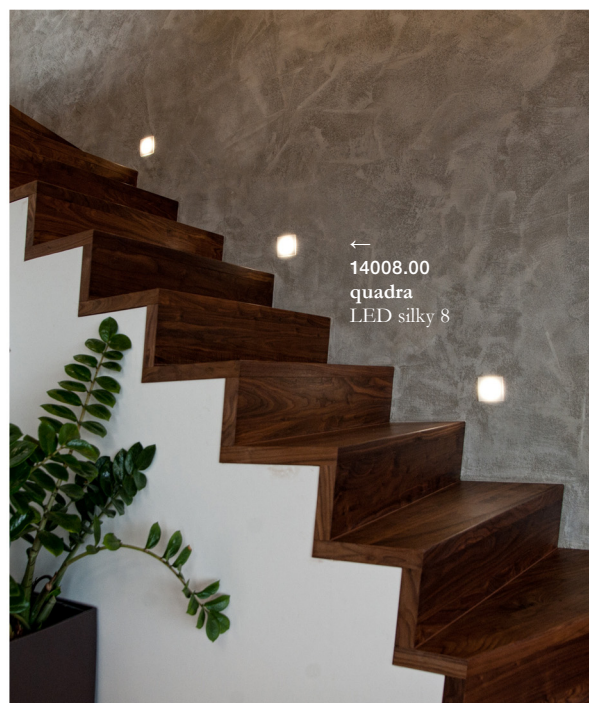

retro corona



retro corona 110

15110.00

výzbroj/equipment
4x39 W T5 G5

napětí/voltage
230 V

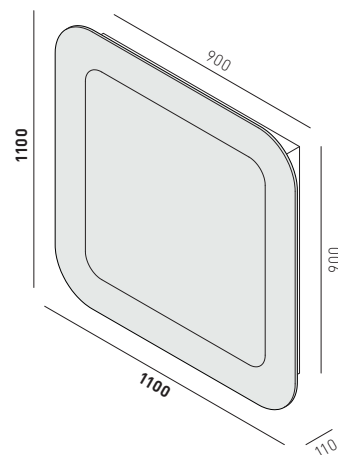

retro corona 54

15054.00

výzbroj/equipment
4x36 W TC-L 2G11
8040 lm LED

napětí/voltage
230 V

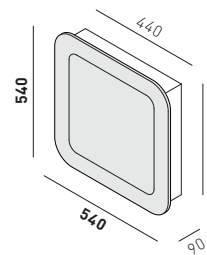

retro corona 32

15032.00

výzbroj/equipment
2x 24 W TC-F 2G10
2010 lm LED

napětí/voltage
230 V

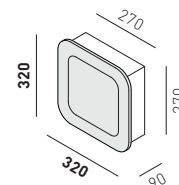

retro corona 18

15018.00

výzbroj/equipment
1x 18 W TC-F 2G10
2000 lm LED

napětí/voltage
230 V

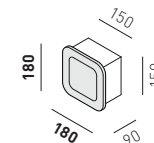

retro corona 14

15014.00

výzbroj/equipment
2x 15 W E27

napětí/voltage
230 V

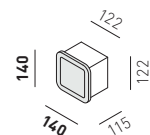

retro LED corona 8

15008.00

výzbroj/equipment
1 W LED

napětí/voltage
12 V DC

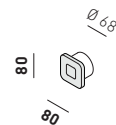

Provedení/Finish:

.00

.01

.02

Kolekce retro corona využívá stejně jako kolekce quadra systému univerzálních vestavných těl uni.body a patentovaného magnetického uchycení krytu z akrylátového skla Perspex®. Zaoblené rohy krytu působí svěžím retro dojmem.

Like the quadra collection, the retro corona collection uses a system of universal recessed uni.body fixtures and patented magnetic mounts for Perspex® acrylic glass covers. The rounded corners of the cover create a fresh retro feel.



retro silky



retro silky 54

retro silky 32

retro silky 18

retro silky14

17054.00

výzbroj/equipment
4x36 W TC-L 2G11
8040 lm LED

napětí/voltage
230 V

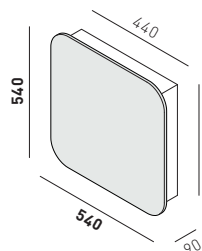

17032.00

výzbroj/equipment
2x 24 W TC-F 2G10
2010 lm LED

napětí/voltage
230 V

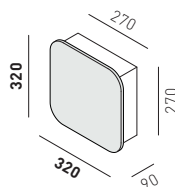

17018.00

výzbroj/equipment
1x 18 W TC-F 2G10
2000 lm LED

napětí/voltage
230 V

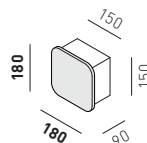

17014.00

výzbroj/equipment
2x 15 W E27

napětí/voltage
230 V

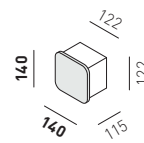

retro LED silky 8

17008.00

výzbroj/equipment
1 W LED

napětí/voltage
12 V DC

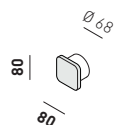

Magnetický kryt svítidel z matného akrylátového kolekce retro silky není osazen viditelným kovovým rámečkem, vytváří tak minimalistickou alternativu ke kolekci retro corona.

The magnetic fixture cover of the retro silky collection is made of frosted acrylic and doesn't have any metal frame, thus creating a minimalist alternative to the retro corona collection.

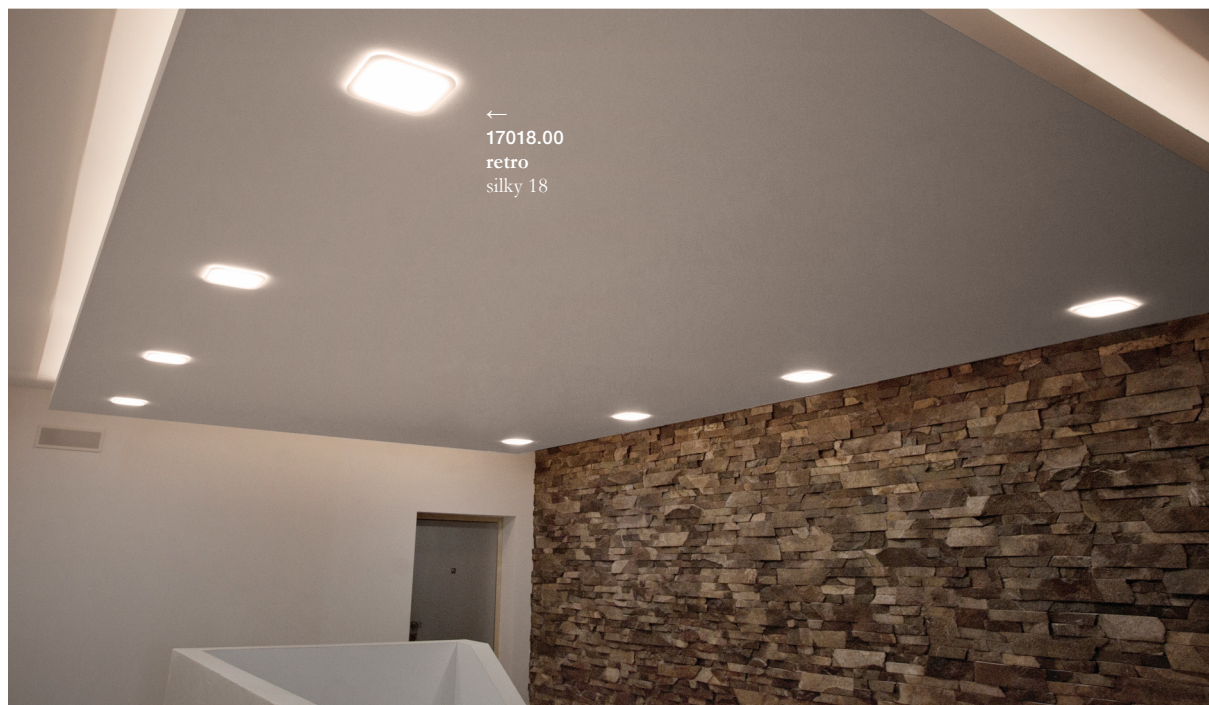

zig zag



zig zag 128

zig zag 72

zig zag 44

zig zag 22

18128.00

výzbroj/equipment
4x 39 W T5 G5

napětí/voltage
230 V

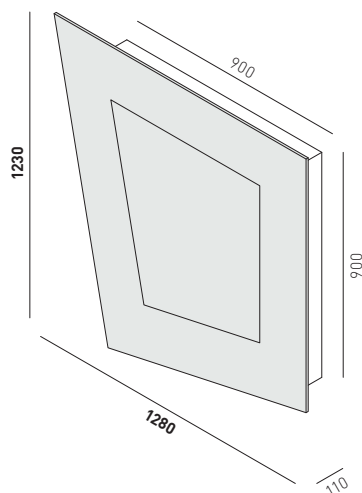

18072.00

výzbroj/equipment
4x 36 W TC-L 2G11
8040 lm LED

napětí/voltage
230 V

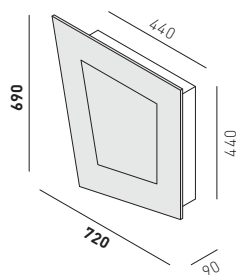

18044.00

výzbroj/equipment
2x 24 W TC-F 2G10
2010 lm LED

napětí/voltage
230 V

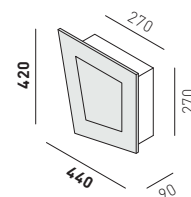

18022.00

výzbroj/equipment
1x 18 W TC-F 2G10
2000 lm LED

napětí/voltage
230 V

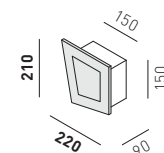

zig zag LED 10

18010.00

výzbroj/equipment
1 W LED

napětí/voltage
12 V DC

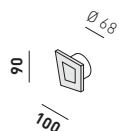

Ukázka kompozice/Sample composition

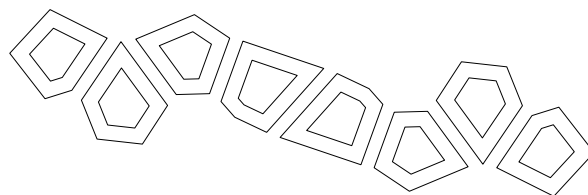

Provedení/Finish:

.00

.01

.02

Hlavní předností kolekce zig zag je rozmanitost. Kryty jednotlivých svítidel se vyrábí vždy v několika tvarových variantách, což umožňuje vytvářet působivé, hravé a originální kompozice.

The main advantage of the zig zag collection is variety. The covers of individual lights are always produced in several different shapes, giving a playful impression of originality.



up corona



up corona 95

up corona 50

up corona 35

up corona 20

19095.00

výzbroj/equipment
4x39 W T5 G5

napětí/voltage
230 V

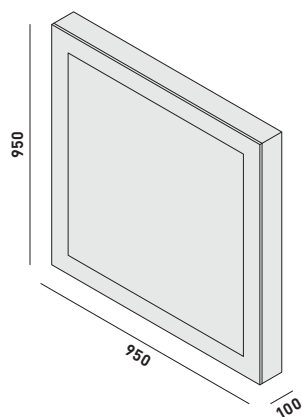

19050.00

výzbroj/equipment
4x36 W TC-L 2G11
8040 lm LED

napětí/voltage
230 V

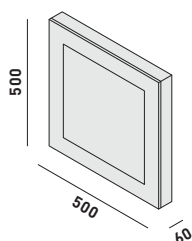

19035.00

výzbroj/equipment
2x 36 W TC-F 2G10
3007 lm LED

napětí/voltage
230 V

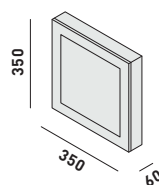

19020.00

výzbroj/equipment
1x 24 W TC-F 2G10
2000 lm LED

napětí/voltage
230 V

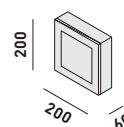

up corona 62

up corona 40

19062.00

výzbroj/equipment
1x 55 W TC-L 2G11
4134 lm LED

napětí/voltage
230 V

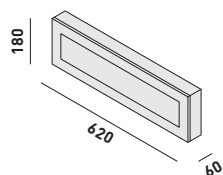

19040.00

výzbroj/equipment
1x 24 W TC-L 2G11
2756 lm LED

napětí/voltage
230 V

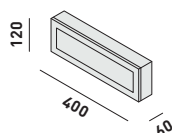

up LED corona 10

19010.00

výzbroj/equipment
4 W power LED

napětí/voltage
230 V

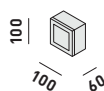

Provedení/Finish:

.00

.01

.02

Pro minimalistickou kolekci up je charakteristické precizní zpracování montury z kartáčované nerez oceli a krytu z akrylátového skla se systémem magnetického uchycení.

This minimalist collection is characterized by a precision-crafted brushed stainless steel mount and acrylic glass cover with magnetic mounts.



mystic meridia



mystic meridia 85

mystic meridia 65

mystic meridia 55

22085.00

výzbroj/equipment
4x 24 W TC-L 2G11
8008 lm LED

napětí/voltage
230 V

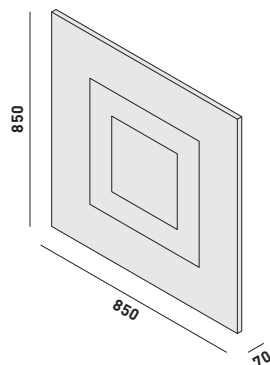

22065.00

výzbroj/equipment
1x 55 W T16-R 2Gx13
4004 lm LED

napětí/voltage
230 V

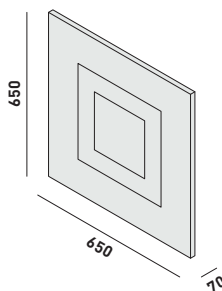

22055.00

výzbroj/equipment
1x 55 W T16-R 2Gx13
4004 lm LED

napětí/voltage
230 V

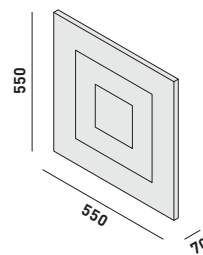

Provedení/Finish:

.00

.01

.02

Exkluzivní stropní přisazená svítidla z kolekce mystic meridia poskytují jemné a měkké osvětlení. Charakteristickým prvkem kolekce je 20 milimetrů silný kryt z akrylátového skla v matné úpravě.

The exclusive surface ceiling mount lights of the mystic meridia collection provide subtle, soft lighting. The hallmark of the collection is the 20 mm thick cover made of frosted acrylic glass.

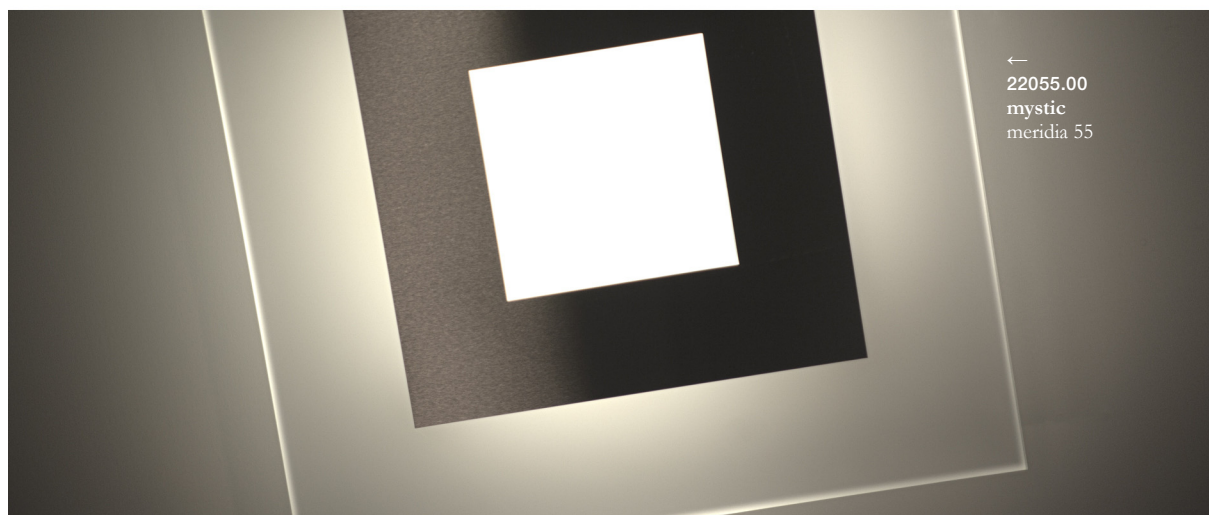
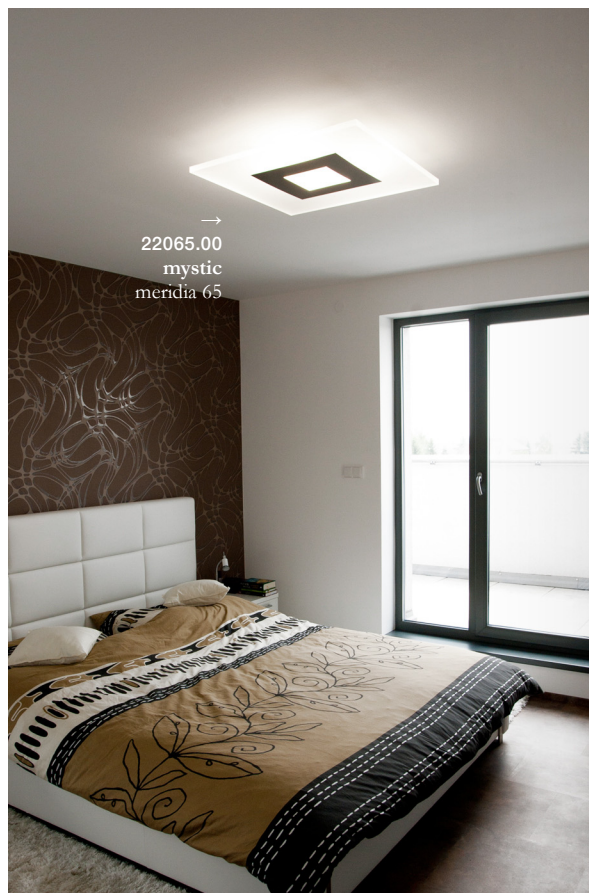

mystic dione



mystic dione 150+LED

22150.00+LED

výzbroj/equipment
2x 39 W T5 G5 + LED 15 W

napětí/voltage
230 V

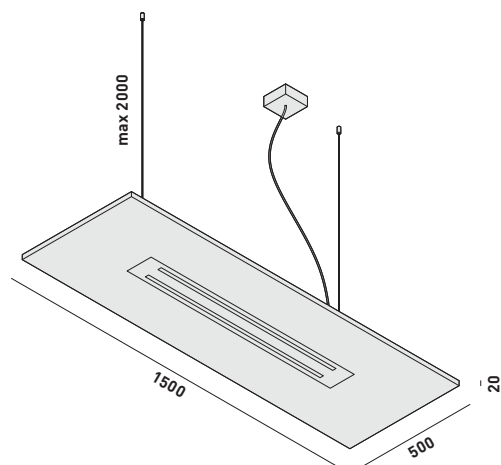

mystic dione 150

22150.00

výzbroj/equipment
2x 39 W T5 G5

napětí/voltage
230 V

mystic dione 113

22113.00

výzbroj/equipment
2x 39 W T5 G5

napětí/voltage
230 V

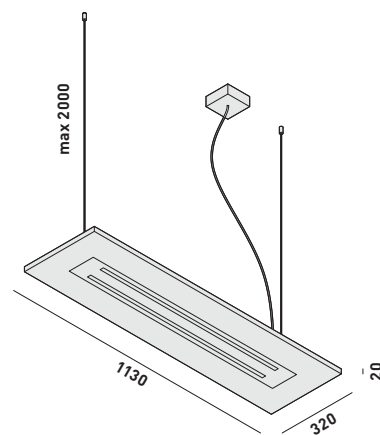

Provedení/Finish:

.00

.01

.02

Lustry z kolece mystic dione nabízí minimalistický design, dokonalé zpracování a vyvážený poměr přímého a nepřímého osvětlení.

The chandeliers of the mystic dione collection feature a minimalist design, excellent craftsmanship, and a fine balance between direct and indirect lighting.



mystic metis



mystic metis 128

mystic metis 98

mystic metis 68

mystic metis 32

22128.00**22098.00****22068.00****22032.00**

výzbroj/equipment
1x 28 W SLS G5

výzbroj/equipment
1x 21 W SLS G5

výzbroj/equipment
1x 24 W SLS G5

výzbroj/equipment
1x 16 W CF-L GR10q
200 lm LED

napětí/voltage
230 V

napětí/voltage
230 V

napětí/voltage
230 V

napětí/voltage
230 V

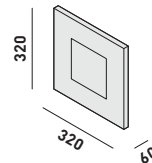
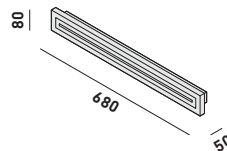
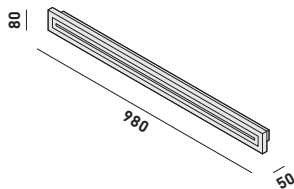
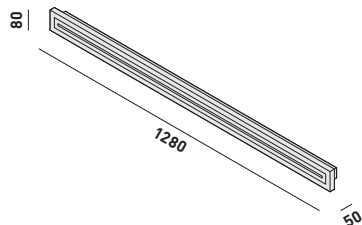

Provedení/Finish:

.00

.01

.02

Svítlidla z kolekce mystic metis je možné upevnit jak na strop, tak na stěnu. Charakteristickým prvkem kolekce je 20 mm silný kryt z akrylátového skla v matné úpravě.

Luminaires from the mystic metis collection can be mounted on both ceilings and walls. The hallmark of the collection is the 20 mm thick cover made of frosted acrylic glass.



←
22068.00
mystic
metis 68



→
22098.00
mystic
metis 98



→
22032.00
mystic
metis 32

mystic io



mystic io 10

mystic io 11

22010.00**22011.00**

výzbroj/equipment

8 W Power LED

napětí/voltage

230 V

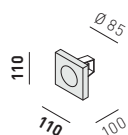

výzbroj/equipment

8 W Power LED

napětí/voltage

230 V

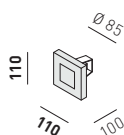

Provedení/Finish:

.00

.01

.02

Bodové svítidlo mystic io poskytuje díky 8 W LED modulu dostatek světla i vzhledem ke své velikosti. Kryt svítidla je tvořen 20 mm silnou deskou z akrylátového skla v matné úpravě doplněné nerez stínidlem.

Thanks to its 8 W LED module, the mystic io spotlight system offers plenty of light, despite its size. Light fixtures are covered with a 20 mm thick plate of frosted acrylic glass with a stainless steel shade.



x-line zen



x-line zen 48

x-line zen 37

x-line zen 18

23548. __**23537. __****23518. __**

výzbroj/equipment
2x 24 W TC-L 2G11
3007 lm LED

napětí/voltage
230 V

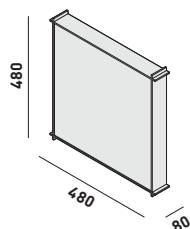

výzbroj/equipment
2x 18 W TC-L 2G11
2010 lm LED

napětí/voltage
230 V

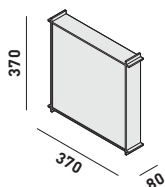

výzbroj/equipment
1x 24 W TC-L 2G11
1378 lm LED

napětí/voltage
230 V

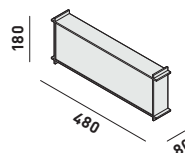

Svítidla x-line zen jsou vyráběna v černé a bílé barvě ve vysokém lesku. Charakteristickým znakem této kolekce je vtipná a jednoduchá konstrukce, decentní osvětlení stropu a neotřelý originální design.

X-line zen luminaires come in high gloss black or white. This collection is distinguished by its simple and clever construction, subtle ceiling light, and novel design.

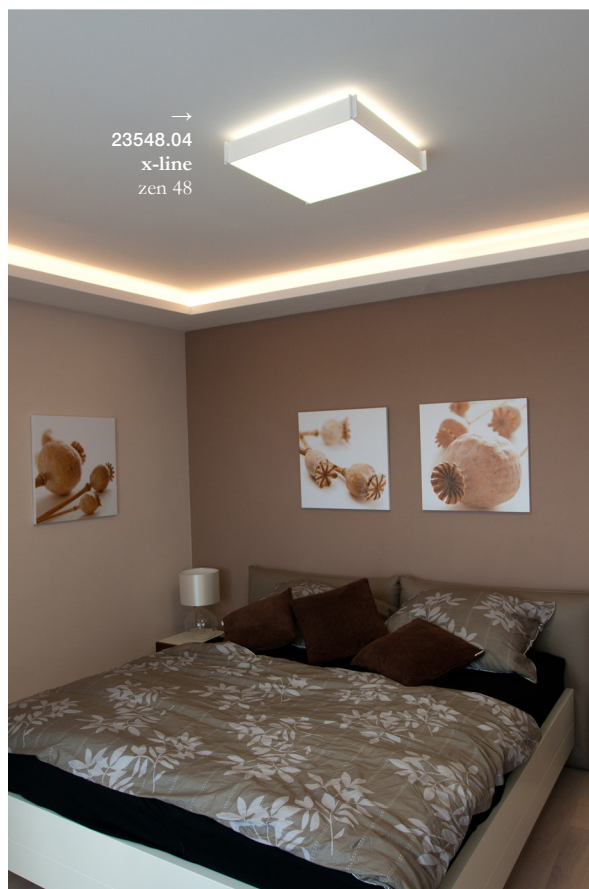

x-line color



x-line color 48

x-line color 37

x-line color 18

23048. __**23037. __****23018. __**

výzbroj/equipment
2x 24 W TC-L 2G11
3007 lm LED

napětí/voltage
230 V

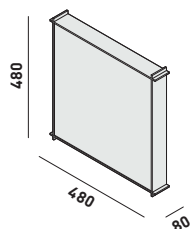

výzbroj/equipment
2x 18 W TC-L 2G11
2010 lm LED

napětí/voltage
230 V

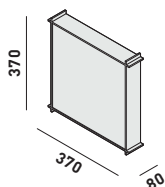

výzbroj/equipment
1x 24 W TC-L 2G11
1378 lm LED

napětí/voltage
230 V

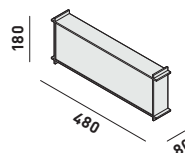

Provedení/Finish:



Svítidla x-line color září barvami. Tělo svítidla je sestaveno z barevných desek z akrylátové skla Perspex®, v nabídce je sedm barevných variant. Dalším charakteristickým znakem této kolekce je vtipná a jednoduchá konstrukce.

X-line color luminaires radiate color. The light fixture is made of colored plates of Perspex® acrylic glass, and the line offers a total of seven color variations. Another distinguishing feature of the collection is its simple and clever construction.



ledissimo direct



ledissimo direct 22

ledissimo direct 17

ledissimo direct 14

24022.00

výzbroj/equipment
22x 2 W LED

napětí/voltage
230 V

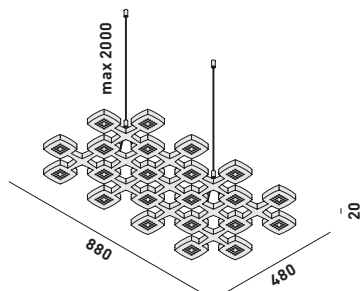

24017.00

výzbroj/equipment
17x 2 W LED

napětí/voltage
230 V

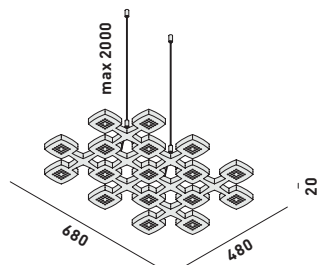

24014.00

výzbroj/equipment
14x 2 W LED

napětí/voltage
230 V

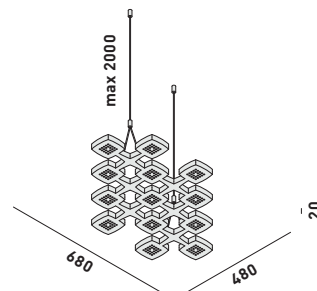

ledissimo direct 13

ledissimo direct 10

24013.00

výzbroj/equipment
13x 2 W LED

napětí/voltage
230 V

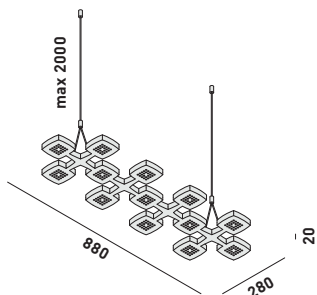

24010.00

výzbroj/equipment
10x 2 W LED

napětí/voltage
230 V

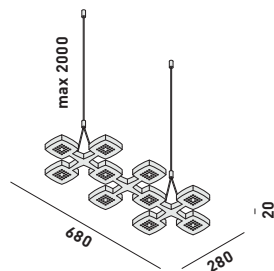

Lustry ledissimo direct nabízí unikátní design a širokou variabilitu tvarů. Kombinací těchto svítidel lze vytvořit působivé prostorové sestavy. Pro tuto kolekci jsou LED zdroje vyráběny speciálně na zakázku.

Ledissimo direct chandeliers offer a unique design and wide variety of shapes. Impressive spatial effects can be created using combinations of these lights. LED light sources can be custom ordered for this collection.

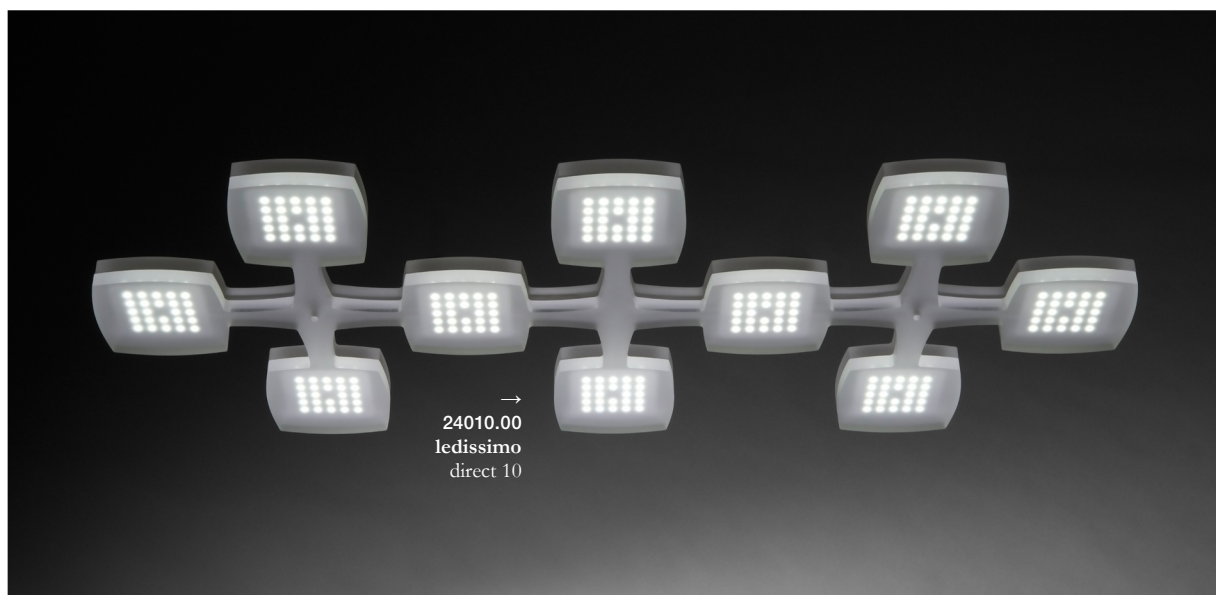

ledissimo indirect



ledissimo indirect 22

24122.00

výzbroj/equipment
22x 2 W LED

napětí/voltage
230 V

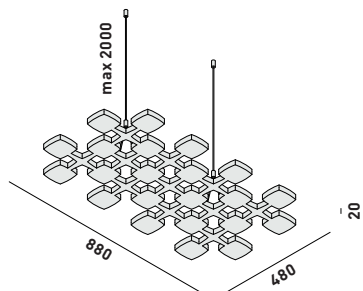

ledissimo indirect 17

24117.00

výzbroj/equipment
17x 2 W LED

napětí/voltage
230 V

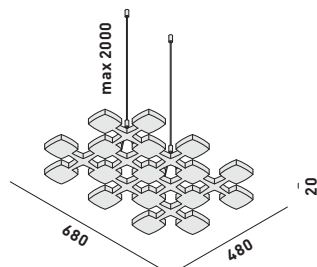

ledissimo indirect 14

24114.00

výzbroj/equipment
14x 2 W LED

napětí/voltage
230 V

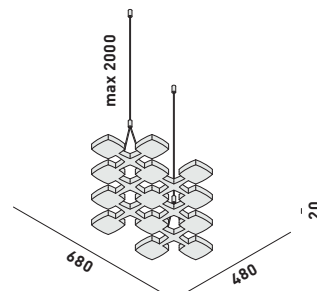

ledissimo indirect 13

24113.00

výzbroj/equipment
13x 2 W LED

napětí/voltage
230 V

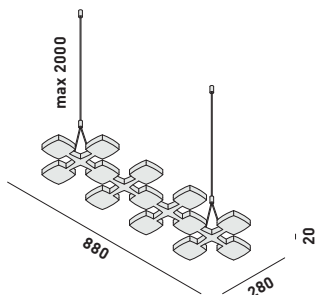

ledissimo indirect 10

24110.00

výzbroj/equipment
10x 2 W LED

napětí/voltage
230 V

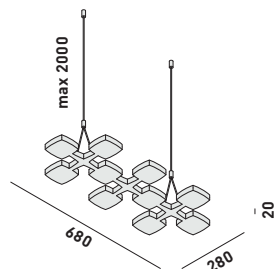

Lustry z kolekce ledissimo indirect vytváří intimní a měkké nepřímé osvětlení. Stejně jako v případě sesterské kolekce ledissimo direct je možné vytvářet originální prostorové kompozice z několika rozměrových variant.

Ledissimo indirect chandeliers create intimate and soft indirect lighting. Just like their sister collection ledissimo direct, it is possible to create original spatial compositions by using several different-sized fixtures.



lotus



lotus 125

lotus 85

50125. __

výzbroj/equipment
129 W LED

napětí/voltage
230 V

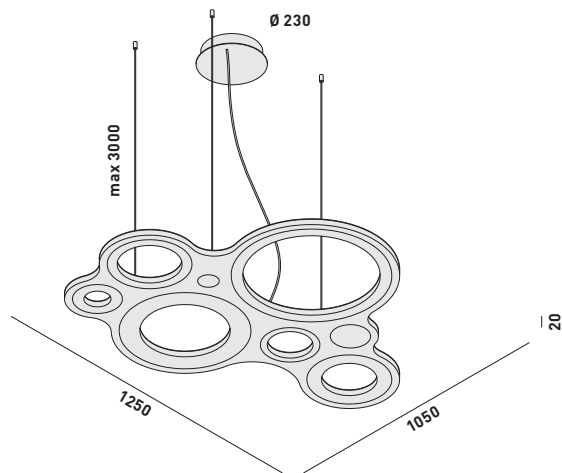

50085. __

výzbroj/equipment
116 W LED

napětí/voltage
230 V

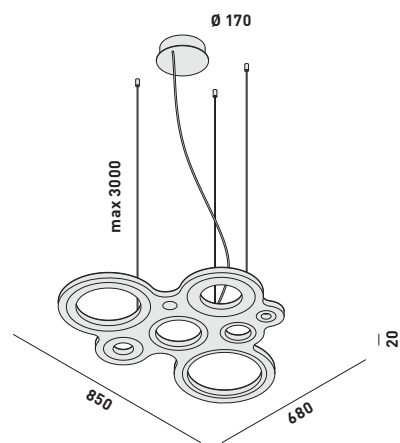

Provedení/Finish:

.04

.05

Design svítidla Lotus se všemi závěsnými lanky a přívodními kabely lze chápat jako analogii vodních rostlin se svými kruhovými listy na hladině a soustavou stonků pod ní. Díky dvěma velikostním variantám pak lze vytvářet rozsáhlé, závěsné či nástěnné, přirozeně na sebe navazující struktury.

The design of Lotus lights with their hanging lines and power cables can be compared to water plants with their round leaves on the surface and stems below. As there are two different sizes, it is possible to create extensive hanging or wall-mounted structures which naturally tie in to one another.

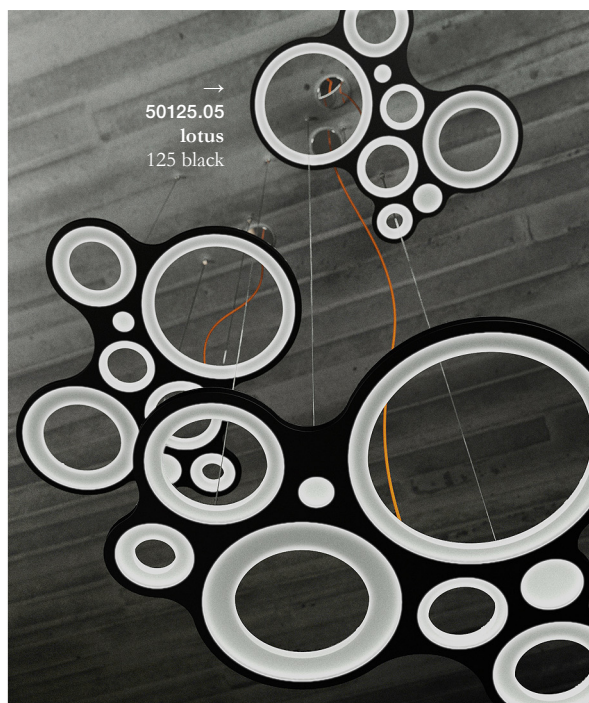

tube



tube 120/1000

tube 120/700

tube 120/500

tube 105/860

tube 105/600

tube 105/430

61210.00**61270.00****61250.00****61086.00****61060.00****61043.00**

výzbroj/equipment

11 W LED PAR 30

90mm, 680 lm

napětí/voltage

230 V

výzbroj/equipment

11 W LED PAR 30

90mm, 680 lm

napětí/voltage

230 V

výzbroj/equipment

11 W LED PAR 30

90mm, 680 lm

napětí/voltage

230 V

výzbroj/ equipment

11 W LED PAR 30

90mm, 680 lm

napětí/voltage

230 V

výzbroj/equipment

11 W LED PAR 30

90mm, 680 lm

napětí/voltage

230 V

výzbroj/equipment

11 W LED PAR 30

90mm, 680 lm

napětí/voltage

230 V

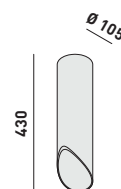
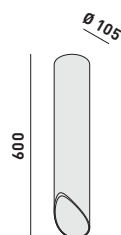
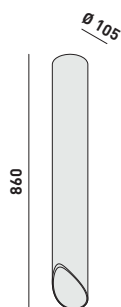
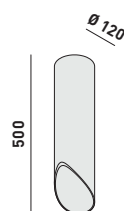
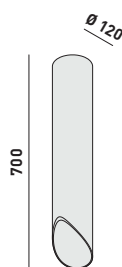
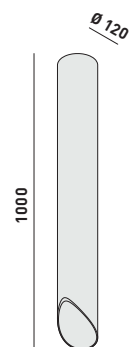

tube 75/740

tube 75/520

tube 75/360

tube 50/640

tube 50/430

tube 50/300

61210.00**61270.00****61250.00****61086.00****61060.00****61043.00**

výzbroj/equipment

11 W LED PAR 30

90mm, 345 lm

napětí/voltage

230 V

výzbroj/equipment

11 W LED PAR 30

90mm, 345 lm

napětí/voltage

230 V

výzbroj/equipment

11 W LED PAR 30

90mm, 345 lm

napětí/voltage

230 V

výzbroj/ equipment

11 W LED PAR 30

90mm, 190 lm

napětí/voltage

230 V

výzbroj/ equipment

11 W LED PAR 30

90mm, 190 lm

napětí/voltage

230 V

výzbroj/equipment

11 W LED PAR 30

90mm, 190 lm

napětí/voltage

230 V

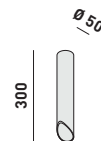
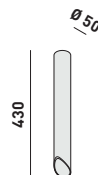
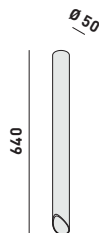
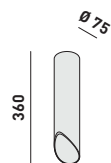
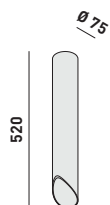
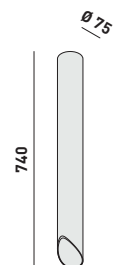

Provedení/Finish:



Tube je kolekci ambientních svítidel s minimalistickým designem. Jednoduchá, čistá forma bez viditelných spojů spolu s precizním provedením z nich dělá ideální architektonický prvek. Díky jednoduchému způsobu instalace a širokému výběru proporcí i barev lze vytvářet rozměrné a originální kompozice.



Tube is a collection of ambient lights with minimalist design. Simple and clean forms with no visible mounts and precision crafting make these fixtures ideal for architecture. Thanks to their simple installation and wide range of colors and sizes, one can create large original compositions.



mercur



mercur LED 1375

40137.00

výzbroj/equipment
42 W LED

napětí/voltage
12 V/DC

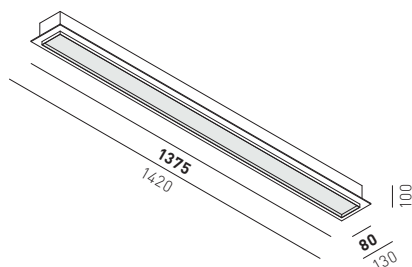

mercur LED 1075

41107.00

výzbroj/equipment
33 W LED

napětí/voltage
12 V/DC

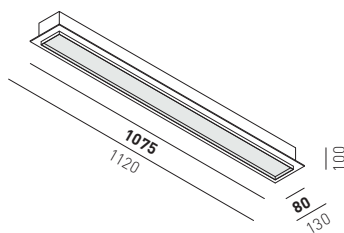

mercur LED 775

42775.00

výzbroj/equipment
24 W LED

napětí/voltage
12 V/DC

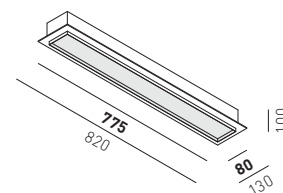

lotus LED 475

43475.00

výzbroj/equipment
15 W LED

napětí/voltage
12 V/DC

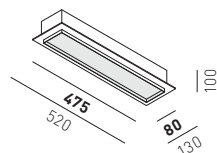

Mercur je kolekce minimalistických zápusných svítidel bez viditelného rámečku. Nabízené rozměry je možné propojovat mezi sebou a vytvářet tak plynulé světelné pruhy.

Mercur is a collection of minimalist recessed light fixtures without any visible frame. The dimensions offered can be combined to create continuous bands of light.



infos



infos 50

infos 30

infos 18

infos 14

16050.00

výzbroj/equipment
4x 36 W TC-L 2G11
8040 lm LED

napětí/voltage
230 V

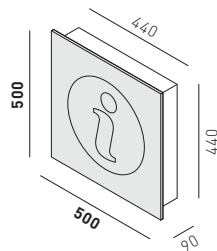

16030.00

výzbroj/equipment
2x 24 W TC-F 2G10
2010 lm LED

napětí/voltage
230 V

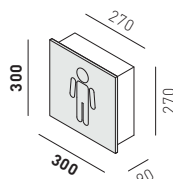

16018.00

výzbroj/equipment
1x 18 W TC-F 2G10
2000 lm LED

napětí/voltage
230 V

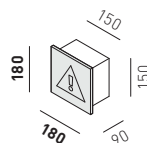

16014.00

výzbroj/equipment
2x 15 W E27

napětí/voltage
230 V

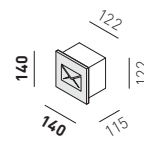

infos 64

infos 43

16064.00

výzbroj/equipment
1x 55 W TC-L 2G11
4134 lm LED

napětí/voltage
230 V

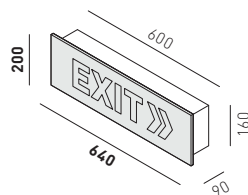

16043.00

výzbroj/equipment
1x 24 W TC-L 2G11
2756 lm LED

napětí/voltage
230 V

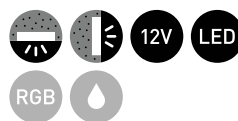
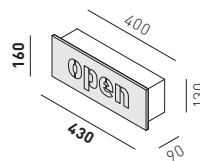

infos LED 15

16015.00

výzbroj/equipment
1,5 W LED

napětí/voltage
12 V DC

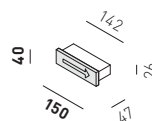

infos LED 8

16008.00

výzbroj/equipment
1 W LED

napětí/voltage
12 V DC

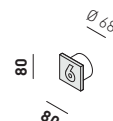

Provedení/Finish:

.00

.01

.02

Z prvků kolekce infos lze vytvořit originální informační systém. Do plochy z nerezové oceli je možné vyfrézovat logo, piktogram, text, nebo jakoukoliv jinou grafickou aplikaci dle požadavku.

The infos collection can be used to create original signage. Logos, pictograms, texts or any other graphics can be cut into stainless steel sheet to meet your needs.

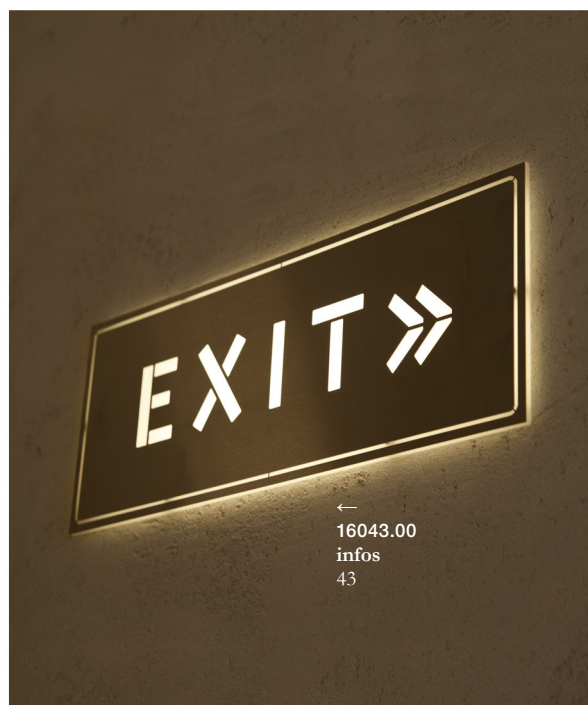
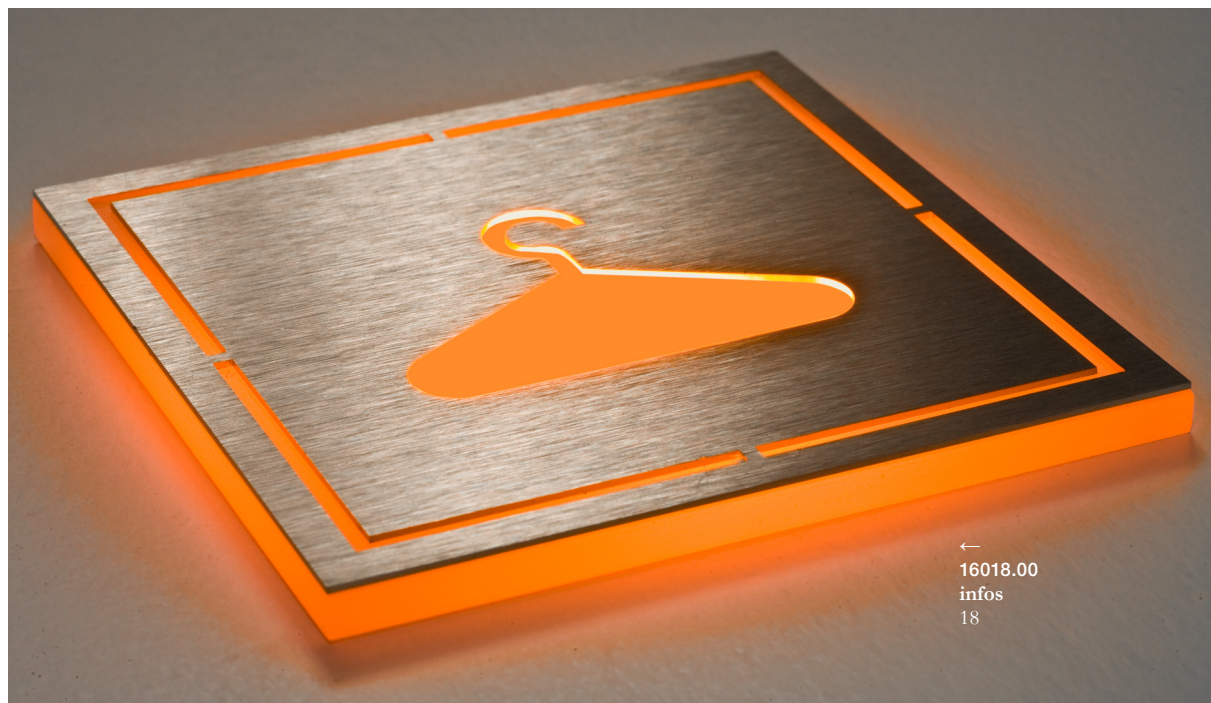

Rejstřík

Index

018

quadra

corona

quadra corona 95

12095.00**rozměry/dimensions****950 x 950 mm**

900 x 900 x 110 mm

váha/weight**14.9 kg**

quadra corona 50

12050.00**rozměry/dimensions****500 x 500 mm**

440 x 440 x 90 mm

váha/weight**7.9 kg**

quadra corona 30

12030.00**rozměry/dimensions****300 x 300 mm**

270 x 270 x 90 mm

váha/weight**2.9 kg**

quadra corona 18

12018.00**rozměry/dimensions****180 x 180 mm**

150 x 150 x 90 mm

váha/weight**1.3 kg**

quadra corona 14

12014.00**rozměry/dimensions****140 x 140 mm**

122 x 122 x 115 mm

váha/weight**1.1 kg**

quadra corona 64

12064.00**rozměry/dimensions****640 x 200 mm**

600 x 160 x 90 mm

váha/weight**2.8 kg**

quadra corona 43

12043.00**rozměry/dimensions****430 x 160 mm**

400 x 130 x 90 mm

váha/weight**2.7 kg**

quadra LED corona 15

12015.00**rozměry/dimensions****150 x 40 mm**

142 x 26 x 47 mm

váha/weight**220 g**

quadra LED corona 8

12008.00**rozměry/dimensions****80 x 80 mm**

ø 68 mm

váha/weight**140 g**

020

quadra

silky

quadra silky 50

14050.00**rozměry/dimensions****500 x 500 mm**

440 x 440 x 90 mm

váha/weight**7.9 kg**

quadra silky 30

14030.00**rozměry/dimensions****300 x 300 mm**

270 x 270 x 90 mm

váha/weight**2.9 kg**

quadra silky 18

14018.00**rozměry/dimensions****180 x 180 mm**

150 x 150 x 90 mm

váha/weight**1.3 kg**

quadra silky 14

14014.00**rozměry/dimensions****140 x 140 mm**

122 x 122 x 115 mm

váha/weight**1.1 kg**

quadra silky 64

14064.00**rozměry/dimensions****640 x 200 mm**

600 x 160 x 90 mm

váha/weight**2.8 kg**

quadra silky 43

14043.00**rozměry/dimensions****430 x 160 mm**

400 x 130 x 90 mm

váha/weight**2.7 kg**

quadra LED silky 15

14015.00**rozměry/dimensions****150 x 40 mm**

142 x 26 x 47 mm

váha/weight**220 g**

quadra LED silky 8

14008.00**rozměry/dimensions****80 x 80 mm**

ø 68 mm

váha/weight**140 g**

022

retro

corona

retro corona 18

15018.00

rozměry/dimensions

180 x 180 mm

150 x 150 x 90 mm

váha/weight

1.3 kg

retro corona 110

15110.00

rozměry/dimensions

1100 x 1100 mm

900 x 900 x 110 mm

váha/weight

15.8 kg

retro corona 54

15054.00

rozměry/dimensions

540 x 540 mm

440 x 440 x 90 mm

váha/weight

8.9 kg

retro corona 32

15032.00

rozměry/dimensions

320 x 320 mm

270 x 270 x 90 mm

váha/weight

3.1 kg

retro corona 14

15014.00

rozměry/dimensions

140 x 140 mm

122 x 122 x 115 mm

váha/weight

1.1 kg

retro LED corona 8

15008.00

rozměry/dimensions

80 x 80 mm

Ø 68 mm

váha/weight

140 g

024

retro

silky

retro silky 14

17014.00

rozměry/dimensions

140 x 140 mm

122 x 122 x 115 mm

váha/weight

1.1 kg

retro silky 54

17054.00

rozměry/dimensions

540 x 540 mm

440 x 440 x 90 mm

váha/weight

8.9 kg

retro silky 32

17032.00

rozměry/dimensions

320 x 320 mm

270 x 270 x 90 mm

váha/weight

3.1 kg

retro silky 18

17018.00

rozměry/dimensions

180 x 180 mm

150 x 150 x 90 mm

váha/weight

1.3 kg

zig zag 72

18072.00

rozměry/dimensions

720 x 690 mm

440 x 440 x 90 mm

váha/weight

8.9 kg

zig zag 44

18044.00

rozměry/dimensions

440 x 420 mm

270 x 270 x 90 mm

váha/weight

3.1 kg

026

zig zag

zig zag 22

18022.00

rozměry/dimensions

220 x 210 mm

150 x 150 x 90 mm

váha/weight

1.3 kg

zig zag 128

18128.00

rozměry/dimensions

1280 x 1230 mm

900 x 900 x 110 mm

váha/weight

16.1 kg

zig zag LED 10

18010.00

rozměry/dimensions

100 x 100 mm

Ø 68 mm

váha/weight

140 g

028

up

corona

up corona 95

19095.00

rozměry/dimensions
950 x 950 x 100 mm

váha/weight
17.8 kg

up corona 50

19050.00

rozměry/dimensions
500 x 500 x 60 mm

váha/weight
9.4 kg

up corona 35

19035.00

rozměry/dimensions
350 x 350 x 60 mm

váha/weight
4.8 kg

up corona 20

19020.00

rozměry/dimensions
200 x 200 x 60 mm

váha/weight
2.0 kg

up corona 62

19062.00

rozměry/dimensions
620 x 180 x 60 mm

váha/weight
3.6 kg

up corona 40

19040.00

rozměry/dimensions
400 x 120 x 60 mm

váha/weight
2.2 kg

up LED corona 10

19010.00

rozměry/dimensions
100 x 100 x 60 mm

váha/weight
600 g

030

mystic

meridia

mystic meridia 85

22085.00

rozměry/dimensions
850 x 850 x 70 mm

váha/weight
9.2 kg

mystic meridia 65

22065.00

rozměry/dimensions
650 x 650 x 70 mm

váha/weight
7.4 kg

mystic meridia 55

22055.00

rozměry/dimensions
550 x 550 x 70 mm

váha/weight
6.9 kg

032

mystic

dione

mystic dione 150+LED

22150.00+LED

rozměry/dimensions
1500 x 500 x 20 mm

váha/weight
16.7 kg

mystic dione 150

22150.00

rozměry/dimensions
1500 x 500 x 20 mm

váha/weight
16.7 kg

mystic dione 113

22113.00

rozměry/dimensions
1130 x 320 x 20 mm

váha/weight
11.3 kg

034

mystic

metis

mystic metis 128

22128.00

rozměry/dimensions
1280 x 80 x 50 mm

váha/weight
2.1 kg

mystic metis 98

22098.00

rozměry/dimensions
980 x 80 x 50 mm

váha/weight
1.8 kg

mystic metis 68

22068.00

rozměry/dimensions
680 x 80 x 50 mm

váha/weight
1.5 kg

mystic metis 32

22032.00rozměry/dimensions
320 x 320 x 60 mmváha/weight
2.4 kg

036

mystic

io

mystic io 10

22010.00rozměry/dimensions
110 x 110 mm
100 x Ø 85 mmváha/weight
450 g

mystic io 11

22011.00rozměry/dimensions
110 x 110 mm
100 x Ø 85 mmváha/weight
450 g

038

x-line

zen

x-line zen 48

23548.____rozměry/dimensions
480 x 480 x 80 mmváha/weight
2.9 kg

x-line zen 37

23537.____rozměry/dimensions
370 x 370 x 80 mmváha/weight
2.4 kg

x-line zen 18

23518.____rozměry/dimensions
480 x 180 x 80 mmváha/weight
1.9 kg

040

x-line

color

x-line color 48

23048.____rozměry/dimensions
480 x 480 x 80 mmváha/weight
2.9 kg

x-line color 37

23037.____rozměry/dimensions
370 x 370 x 80 mmváha/weight
2.4 kg

x-line color 18

23018.____rozměry/dimensions
480 x 180 x 80 mmváha/weight
1.9 kg

042

ledissimo

direct

ledissimo direct 22

24022.00rozměry/dimensions
880 x 480 x 20 mmváha/weight
3.1 kg

ledissimo direct 17

24017.00rozměry/dimensions
680 x 480 x 20 mmváha/weight
2.5 kg

ledissimo direct 14

24014.00rozměry/dimensions
680 x 480 x 20 mmváha/weight
2.1 kg

ledissimo direct 13

24013.00rozměry/dimensions
880 x 280 x 20 mmváha/weight
2.0 kg

ledissimo direct 10

24010.00rozměry/dimensions
680 x 280 x 20 mmváha/weight
1.9 kg

044

ledissimo

indirect

ledissimo indirect 22

24122.00rozměry/dimensions
880 x 480 x 20 mmváha/weight
3.1 kg

ledissimo indirect 17

24117.00rozměry/dimensions
680 x 480 x 20 mmváha/weight
2.5 kg

ledissimo indirect 14

24114.00rozměry/dimensions
680 x 480 x 20 mmváha/weight
2.1 kg

ledissimo indirect 13

24113.00rozměry/dimensions
880 x 280 x 20 mmváha/weight
2.0 kg

ledissimo indirect 10

24110.00rozměry/dimensions
680 x 280 x 20 mmváha/weight
1.9 kg

046

lotus

lotus 125

50125.____rozměry/dimensions
1250 x 1050 x 20 mmváha/weight
9.4 kg

lotus 85

50085.____rozměry/dimensions
850 x 680 x 20 mmváha/weight
6.2 kg

048

tube

tube 120/1000

61210.00rozměry/dimensions
1000 x Ø120 mmváha/weight
3.2 kg

tube 120/700

61270.00rozměry/dimensions
700 x Ø120 mmváha/weight
2.9 kg

tube 120/500

61250.00rozměry/dimensions
500 x Ø120 mmváha/weight
2.6 kg

tube 105/860

61086.00rozměry/dimensions
860 x Ø105 mmváha/weight
3.4 kg

tube 105/600

61060.00rozměry/dimensions
600 x Ø105 mmváha/weight
3.2 kg

tube 105/430

61043.00rozměry/dimensions
430 x Ø105 mmváha/weight
3.1 kg

tube 75/740

61210.00rozměry/dimensions
740 x Ø75 mmváha/weight
2.3 kg

tube 75/520

61270.00rozměry/dimensions
520 x Ø75 mmváha/weight
2.1 kg

tube 75/360

61250.00rozměry/dimensions
360 x Ø75 mmváha/weight
1.9 kg

tube 50/640

61086.00rozměry/dimensions
640 x Ø50 mmváha/weight
1.8 kg

tube 50/430

61060.00rozměry/dimensions
430 x Ø50 mmváha/weight
1.4 kg

tube 50/300

61043.00

rozměry/dimensions
300 x Ø50 mm

váha/weight
1.1 kg

050

mercur

mercur LED 1375

40137.00

rozměry/dimensions
1375 x 80 mm
1420 x 130 x 100 mm

váha/weight
1.5 kg

mercur LED 1075

41107.00

rozměry/dimensions
1075 x 80 mm
1120 x 130 x 100 mm

váha/weight
1.2 kg

mercur LED 775

42775.00

rozměry/dimensions
775 x 80 mm
820 x 130 x 100 mm

váha/weight
900 g

lotus LED 475

43475.00

rozměry/dimensions
475 x 80 mm
520 x 130 x 100 mm

váha/weight
700 g

052

infos

infos 50

16050.00

rozměry/dimensions
500 x 500 mm
440 x 440 x 90 mm

váha/weight
7.9 kg

infos 30

16030.00

rozměry/dimensions
300 x 300 mm
270 x 270 x 90 mm

váha/weight
2.9 kg

infos 18

16018.00

rozměry/dimensions
180 x 180 mm
150 x 150 x 90 mm

váha/weight
1.3 kg

infos 14

16014.00

rozměry/dimensions
140 x 140 mm
122 x 122 x 115 mm

váha/weight
1.1 kg

infos 64

16064.00

rozměry/dimensions
640 x 200 mm
600 x 160 x 90 mm

váha/weight
2.8 kg

infos 43

16043.00

rozměry/dimensions
430 x 160 mm
400 x 130 x 90 mm

váha/weight
2.7 kg

infos LED 15

16015.00

rozměry/dimensions
150 x 40 mm
142 x 26 x 47 mm

váha/weight
220 g

infos LED 8

16008.00

rozměry/dimensions
80 x 80 mm
Ø68 mm

váha/weight
140 g

Materiály

Materials

Akrylátové sklo

Čiré akrylátové sklo Perspex® se vyznačuje vynikající propustností světla (92%), která je srovnatelná se sklem, odolností proti nárazu (5x odolnější než sklo ve stejné tloušťce) a nízkou hmotností (1,19 g/cm³). Lité akrylátové sklo Perspex® vykazuje nízké povrchové pnutí a je odolné vůči UV záření. Pro výrobu používáme barevné, transparentní a translucenční odstíny.

Neodymové magnety (NdFeB)

Neodymové magnety jsou v současnosti nejnovějším a nejsilnějším typem magnetu s vynikajícími magnetickými vlastnostmi a vůbec nejvyšší vnitřní energií jako je remanence a energetická hustota. Magnety uvedeného typu jsou schopny unést více než tisícinásobek vlastní hmotnosti a magnet o velikosti malé mince tak může udržet železný předmět o hmotnosti kolem 10 kg.

Nerezová ocel

Nerezová ocel je obecné pojmenování pro vysocelegované druhy oceli s obsahem chromu, niklu, manganu a dalších sloučenin, vyznačující se zvýšenou odolností vůči chemické i elektrochemické korozi. Nerezové výrobky z produkce Luxlighting jsou nabízeny ve dvou povrchových úpravách: broušený povrch (hrubost 220/240) a zrcadlový 3D lesk

Eloxovaný hliník

Eloxování je druh chemicko-tepelné povrchové úpravy hliníku. Spočívá ve vytvoření tenké ochranné vrstvy, jež zvyšuje odolnost proti vnějším vlivům, mechanickému poškození, zvyšuje pevnost, snižuje drsnost povrchu a celkově prodlužuje životnost výrobku.

Sklo

Sklo je homogenní amorfní, tuhý, inertní materiál odolný proti opotřebení. Vzniká tavením písků s vysokým obsahem oxidu křemičitého a příměsí alkalických látek. Možnosti tvarování materiálu a jeho interakce se světlem jej předurčují k tvorbě osvětlení. V rámci zakázkové výroby Luxlighting využívá všech známých metod zpracování skla a je schopna vyhovět i nejnáročnějším požadavkům.

Acrylic glass

Clear Perspex® acrylic glass exhibits excellent light transmittance (92%) comparable to glass, impact resistance (5x more resistant than glass of the same thickness) and low weight (1.19 g/cm³). Cast Perspex® acrylic glass also has low surface tension and is resistant to UV radiation. For production we use colored, transparent and translucent shades.

Neodymium magnets (NdFeB)

Neodymium magnets are currently the newest and strongest type of magnet with excellent magnetic properties and the highest internal energy, remanence and energy density. Magnets of this type are able to lift more than a thousand times their own weight and a magnet the size of a small coin can hold an iron object weighing around 10 kg.

Stainless steel

Stainless steel is a generic name for high-alloy steels containing chromium, nickel, manganese and other compounds, remarkable for its high resistance to chemical and electrochemical corrosion. Stainless steel Luxlighting products are offered with two surface finishes: a brushed surface (220/240 grit) and mirrored 3D shine.

Anodized aluminium

Anodizing is a type of thermochemical surface treatment of aluminium. It involves creating a thin protective layer that improves resistance against external influences, mechanical damage, increases strength, reduces surface roughness and generally extends the life of the product.

Glass

Glass is a homogeneous, amorphous, solid, inert material resistant to wear. It is formed by melting sand with a high silica content with an admixture of alkaline substances. The ability to shape the material and its interaction with light make it ideal for lighting. Customized Luxlighting products use all known glassworking methods and are able to meet the most demanding requirements.

LED zdroje

V produktech Luxlighting jsou použity výhradně LED moduly TRIDONIC. Moduly mají vysokou účinnost až 168 lm/W, vysoký index podání barev (CRI>80), vydávají perfektně uniformní světlo i v případě propojení několika modulů v řadě. Barevná teploty jsou k dispozici 3000, 4000 a 5000 K. LED moduly nevyžadují přídatné chlazení, jsou osazeny systémem pro snadné propojování jednotlivých modulů, vyznačují se snadnou instalací, dlouhou životností (50.000 hodin) a je na ně poskytována pětiletá záruka.

Elektronické předřadníky

V produktech Luxlighting jsou použity výhradně předřadníky výrobců TRIDONIC a PHILIPS. Oproti tlumivkám a startérům mají elektronické předřadníky nižší hmotnost. Nevydávají také žádné nepříjemné zvuky a díky předehevu elektrod zářivky je zapálení výboje plynulé a jednorázové, zářivka při rozsvícení neblíká. Zářivka je napájena proudem s frekvencí 30 až 50 kHz. Tato frekvence je na rozdíl od 50 Hz u konvenčních předřadníků lidským okem nepostřehnutelná, světlo je klidné a nechvěje se. Princip dvojité konverze a použití filtru na vstupu umožňuje stabilní provoz bez kolísání intenzity světla při různém, i kolísajícím napětí v síti. Vlastní spotřeba elektronických předřadníků je asi třetinová proti sestavě tlumivka-startér-kondenzátor. Specializované elektronické předřadníky umožňují zářivky skutečně řídit (hlavně stmívat), nikoli pouze rozsvítit.

LEDs

Luxlighting products exclusively use TRIDONIC LED modules. The modules are extremely efficient, up to 168 lm / W, with a high color rendering index (CRI> 80), providing perfectly uniform light even when several modules are connected in series. Color temperatures are available for 3000, 4000 and 5000 K. The LED modules do not require additional cooling, are fitted to enable easy connection of individual modules, are easy to install, have a long life (50,000 hours) and come with a five-year warranty.

Electronic ballasts

Luxlighting products exclusively use ballasts made by TRIDONIC and PHILIPS. Electronic ballasts are lighter than inductors and starters. They also don't make any unpleasant noises and, because lamp electrodes are pre-heated, the light turns on at once, smoothly, without any blinking. Lamps are supplied with current at a frequency of 30 to 50 Hz. Unlike frequencies above 50 Hz in conventional ballasts, this frequency is imperceptible to the human eye, so the light is steady and does not flicker. The principle of double conversion and the use of an input filter enables stable operation without fluctuation of light intensity, even when voltage from the grid fluctuates. Electronic ballasts consume about one-third the power of inductor-starter-capacitor assemblies. Specialized electronic ballasts make it possible to actually control fluorescent lights (mainly dimming), not just turn them on.