



NEWTON
ECHOLOGUE



Newton **Track 48**

Pag. 02



Newton **Track 230**

Pag. 14



Newton **Spots**

Pag. 26



Newton **Spot Recessed**

Pag. 32

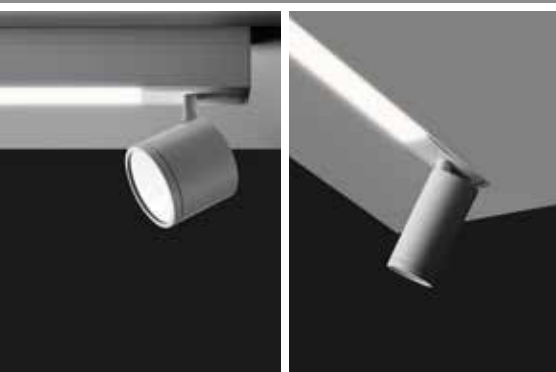

Newton **Rail**

Pag. 36



Newton **Uno/Due**

Pag. 56



NewtonTrack 48

Proiettori di dimensioni ridotte realizzati in alluminio verniciato bianco o nero per Binario 48V.

- Dissipazione passiva
- Inclinazione di 90° su piano orizzontale
- Rotazione di 350° su asse verticale.
- Diverse ottiche disponibili.
- Accessori decorativi.
- Accessori ottici.
- Temperature di colore disponibili: 2700,3000,4000K.
- Aste di diverse lunghezze.

Small sized projectors made of black or white painted aluminum for 48V track.

- *Passive heatsink*
- *90° regulation on horizontal plan*
- *350° rotation on vertical axis*
- *Different beam and optics solutions*
- *Decorative accessories*
- *Optic accessories*
- *Available light tones: 2700, 3000, 4000K*
- *Different rod lengths*

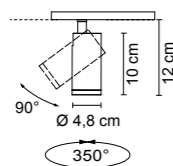
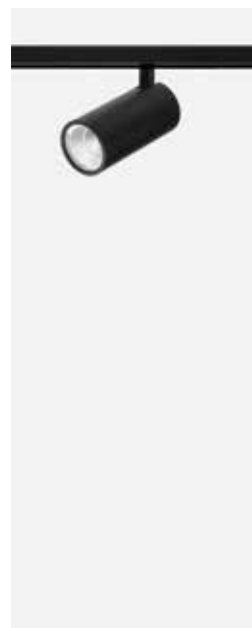

6343 0,40 kg

.01 Bianco - *White*
.02 Nero - *Black*

LED cod.	OPTIC degree/OPTION	Im	LED color
/W	/24 /38 /58	LED 8,9W 500mA	1353lm 4000K
/W/ST	Vetro satinato - <i>Satin glass</i>	LED 8,9W 500mA 38°	1353lm 4000K
/WW	/24 /38 /58	LED 8,9W 500mA	1303lm 3000K
/WW/ST	Vetro satinato - <i>Satin glass</i>	LED 8,9W 500mA 38°	1303lm 3000K
/XW	/24 /38 /58	LED 8,9W 500mA	1244lm 2700K
/XW/ST	Vetro satinato - <i>Satin glass</i>	LED 8,9W 500mA 38°	1244lm 2700K

F **III**

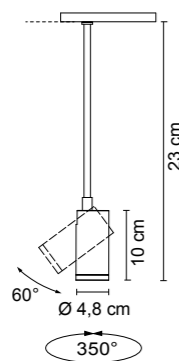
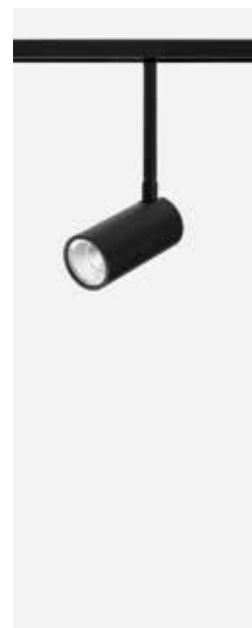

6345 0,50 kg

.01 Bianco - *White*
.02 Nero - *Black*

LED cod.	OPTIC degree/OPTION	Im	LED color
/W	/24 /38 /58	LED 8,9W 500mA	1353lm 4000K
/W/ST	Vetro satinato - <i>Satin glass</i>	LED 8,9W 500mA 38°	1353lm 4000K
/WW	/24 /38 /58	LED 8,9W 500mA	1303lm 3000K
/WW/ST	Vetro satinato - <i>Satin glass</i>	LED 8,9W 500mA 38°	1303lm 3000K
/XW	/24 /38 /58	LED 8,9W 500mA	1244lm 2700K
/XW/ST	Vetro satinato - <i>Satin glass</i>	LED 8,9W 500mA 38°	1244lm 2700K

F **III**

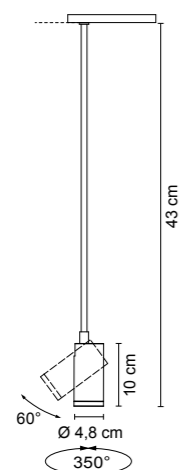

6346 0,60 kg

.01 Bianco - *White*
.02 Nero - *Black*

LED cod.	OPTIC degree/OPTION	Im	LED color
/W	/24 /38 /58	LED 8,9W 500mA	1353lm 4000K
/W/ST	Vetro satinato - <i>Satin glass</i>	LED 8,9W 500mA 38°	1353lm 4000K
/WW	/24 /38 /58	LED 8,9W 500mA	1303lm 3000K
/WW/ST	Vetro satinato - <i>Satin glass</i>	LED 8,9W 500mA 38°	1303lm 3000K
/XW	/24 /38 /58	LED 8,9W 500mA	1244lm 2700K
/XW/ST	Vetro satinato - <i>Satin glass</i>	LED 8,9W 500mA 38°	1244lm 2700K

F **III**



Esempio con e senza 0274 - *Example with or without 0274*



Esempio/ST - *Example/ST*

Ottiche Disponibili - *Available Optics*



/24
Ottica a fascio stretto per luce d'accento
Narrow beam optic for accent lighting



/58
Ottica fascio largo
Wide beam optic



/38
Ottica fascio medio
Medium beam optic



/ST
Ottica fascio diffuso per illuminazione generale
Diffused light optic for general lighting

Accessori - *Accessories*



0267.01
Frangiluce
Louvres



0267.02
Frangiluce
Louvres



0274.01
Schermo antiabbagliamento
Anti-glare screen



0274.02
Schermo antiabbagliamento
Anti-glare screen

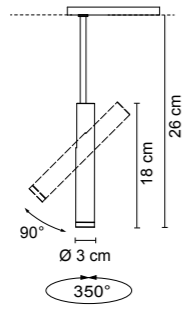

6451

0,50 kg

- .01** Bianco - *White*
- .02** Nero - *Black*

LED cod.	OPTIC degree/OPTION		lm	LED color
/W	/35 /48 /63	LED 8,9W 500mA	1353lm	4000K
/W/ST	Vetro satinato - <i>Satin glass</i>	LED 8,9W 500mA 35°	1353lm	4000K
/WW	/35 /48 /63	LED 8,9W 500mA	1303lm	3000K
/WW/ST	Vetro satinato - <i>Satin glass</i>	LED 8,9W 500mA 35°	1303lm	3000K
/XW	/35 /48 /63	LED 8,9W 500mA	1244lm	2700K
/XW/ST	Vetro satinato - <i>Satin glass</i>	LED 8,9W 500mA 35°	1244lm	2700K

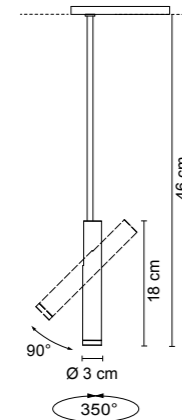

6452

0,60 kg

- .01** Bianco - *White*
- .02** Nero - *Black*

LED cod.	OPTIC degree/OPTION		lm	LED color
/W	/35 /48 /63	LED 8,9W 500mA	1353lm	4000K
/W/ST	Vetro satinato - <i>Satin glass</i>	LED 8,9W 500mA 35°	1353lm	4000K
/WW	/35 /48 /63	LED 8,9W 500mA	1303lm	3000K
/WW/ST	Vetro satinato - <i>Satin glass</i>	LED 8,9W 500mA 35°	1303lm	3000K
/XW	/35 /48 /63	LED 8,9W 500mA	1244lm	2700K
/XW/ST	Vetro satinato - <i>Satin glass</i>	LED 8,9W 500mA 35°	1244lm	2700K

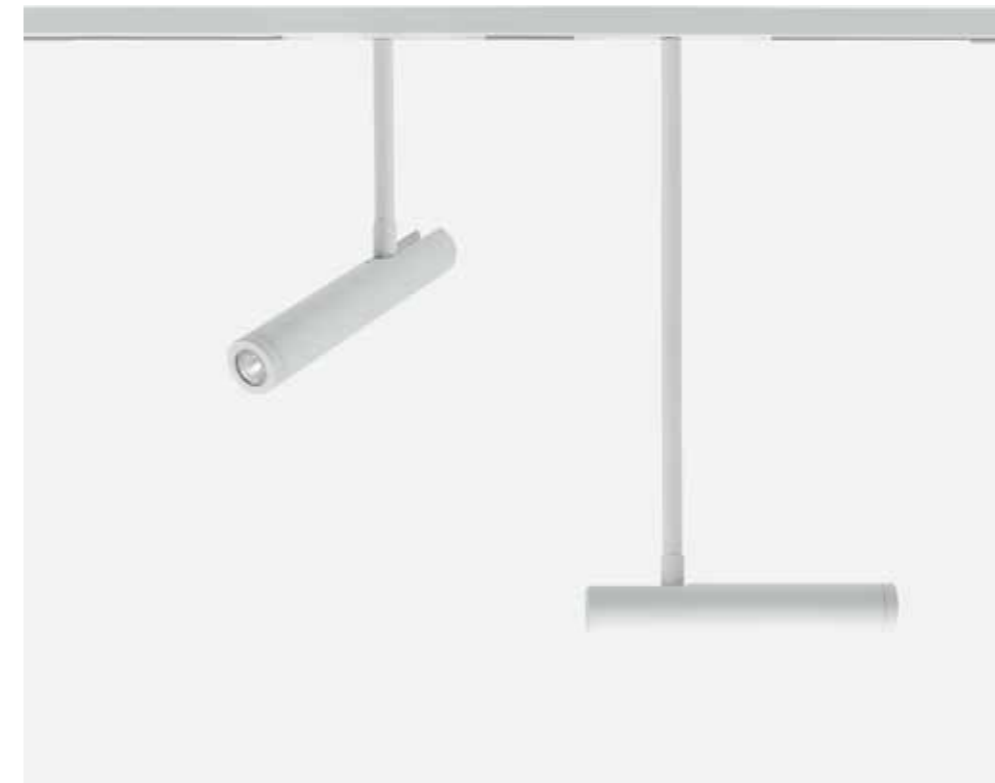

Esempio con 0265 - *Example with 0265*

Ottiche Disponibili - Available Optics



/35
Ottica a fascio stretto per luce d'accento
Narrow beam optic for accent lighting



/63
Ottica fascio largo
Wide beam optic



/48
Ottica fascio medio
Medium beam optic



/ST
Ottica fascio diffuso per illuminazione generale
Diffused light optic for general lighting

Accessori - Accessories



0265.01
Diffusore in vetro Pyrex sabbato
Sand blasted Pyrex glass diffuser



0265.02
Diffusore in vetro Pyrex sabbato
Sand blasted Pyrex glass diffuser

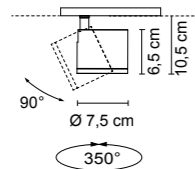
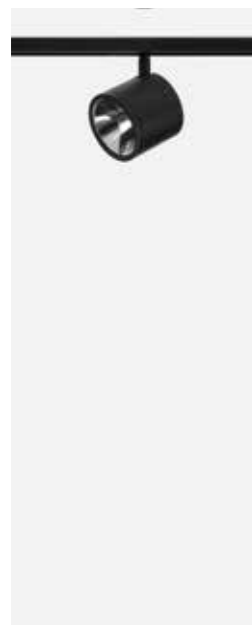

6448 0,50 kg

- .01 Bianco - White
- .02 Nero - Black

LED cod.	OPTIC degree/OPTION	LED	lm	LED color
/W	/13 /40	LED 8,9W 500mA	1353lm	4000K
/W/ST	Vetro satinato - Satin glass	LED 8,9W 500mA 40°	1353lm	4000K
/WW	/13 /40	LED 8,9W 500mA	1303lm	3000K
/WW/ST	Vetro satinato - Satin glass	LED 8,9W 500mA 40°	1303lm	3000K
/XW	/13 /40	LED 8,9W 500mA	1244lm	2700K
/XW/ST	Vetro satinato - Satin glass	LED 8,9W 500mA 40°	1244lm	2700K

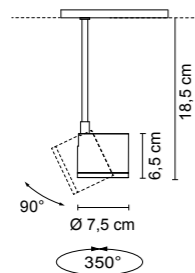
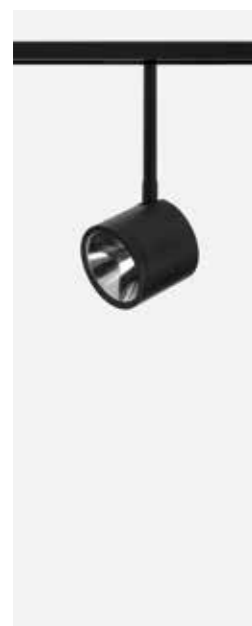

6449 0,60 kg

- .01 Bianco - White
- .02 Nero - Black

LED cod.	OPTIC degree/OPTION	LED	lm	LED color
/W	/13 /40	LED 8,9W 500mA	1353lm	4000K
/W/ST	Vetro satinato - Satin glass	LED 8,9W 500mA 40°	1353lm	4000K
/WW	/13 /40	LED 8,9W 500mA	1303lm	3000K
/WW/ST	Vetro satinato - Satin glass	LED 8,9W 500mA 40°	1303lm	3000K
/XW	/13 /40	LED 8,9W 500mA	1244lm	2700K
/XW/ST	Vetro satinato - Satin glass	LED 8,9W 500mA 40°	1244lm	2700K

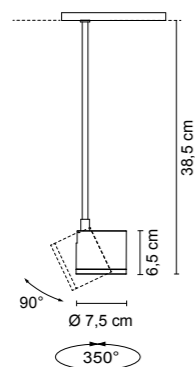

6450 0,70 kg

- .01 Bianco - White
- .02 Nero - Black

LED cod.	OPTIC degree/OPTION	LED	lm	LED color
/W	/13 /40	LED 8,9W 500mA	1353lm	4000K
/W/ST	Vetro satinato - Satin glass	LED 8,9W 500mA 40°	1353lm	4000K
/WW	/13 /40	LED 8,9W 500mA	1303lm	3000K
/WW/ST	Vetro satinato - Satin glass	LED 8,9W 500mA 40°	1303lm	3000K
/XW	/13 /40	LED 8,9W 500mA	1244lm	2700K
/XW/ST	Vetro satinato - Satin glass	LED 8,9W 500mA 40°	1244lm	2700K



Esempio con e senza 0264 - Example with or without 0264



Esempio/ST - Example/ST

Ottiche Disponibili - Available Optics



/13
Ottica a fascio stretto per luce d'accento
Narrow beam optic for accent lighting

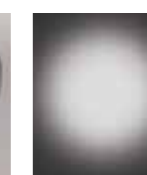

/ST
Ottica fascio diffuso per illuminazione generale
Diffused light optic for general lighting



/40
Ottica fascio largo
Wide beam optic

Accessori - Accessories



0264.01
Parabola decorativa
Decorative parabolic reflector



0264.02
Parabola decorativa
Decorative parabolic reflector

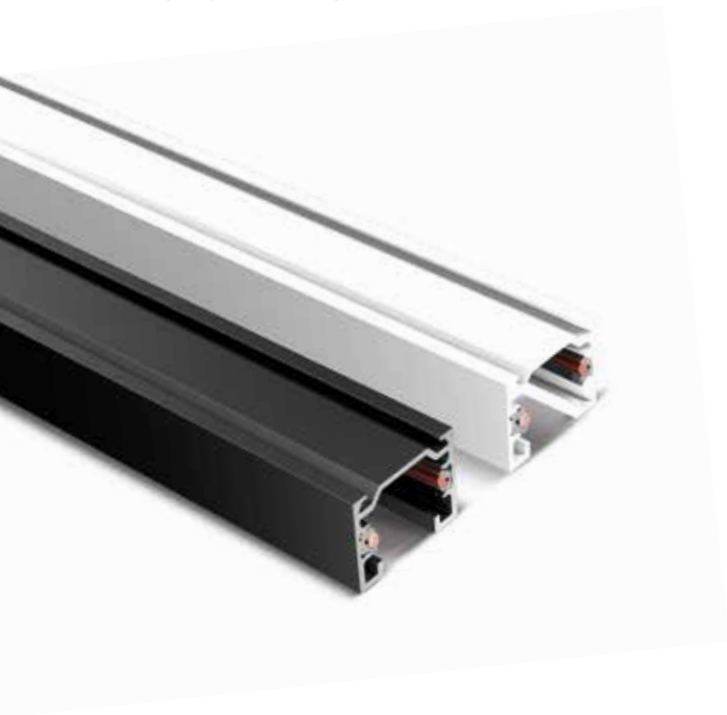

Binari elettrificati a bassa tensione 48V per applicazioni a soffitto, a parete, a sospensione. I due conduttori per 48V portano, a richiesta, anche il segnale DALI consentendo la regolazione dinamica della luce.

48V low voltage electrified tracks for ceiling, wall, suspensions applications. The two 48V conductors can transmit, upon request, also DALI signal, allowing for the light dynamic control.

7341 Binario 48V (20A) 1mt - Track 48V (20A) 1mt

- .01 Bianco - White
- .02 Nero - Black

7342 Binario 48V (20A) 2mt - Track 48V (20A) 2mt

- .01 Bianco - White
- .02 Nero - Black

7343 Binario 48V (20A) 3mt - Track 48V (20A) 3mt

- .01 Bianco - White
- .02 Nero - Black

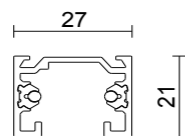

Accessori - Accessories

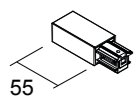

7344S.01/.02
Alimentazione sinistra
Left Live-end

7344D.01/.02
Alimentazione destra
Right Live-end



7349.01/.02
Kit sospensione (cavo 2000mm.)
Suspension kit (cable 2000mm.)



7345.01/.02
Tappo di chiusura
Closing head

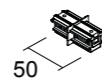

7350.01/.02
Giunto lineare senza contatti
Mechanical connector
(without electrical contacts)

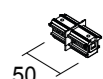

7346.01/.02
Giunto lineare con contatti
Mechanical connector
(with electrical contacts)

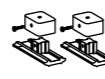

7351.01/.02
Kit soffitto-parete a coppia
Ceiling wall pair

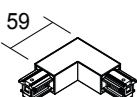

7347.01/.02
Curva 90° interna
90° internal curve

7348.01/.02
Curva 90° esterna
90° external curve

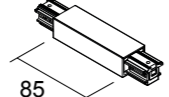

7352.01/.02
Alimentazione centrale
Central Connector

Esempio di configurazione - Configuration example

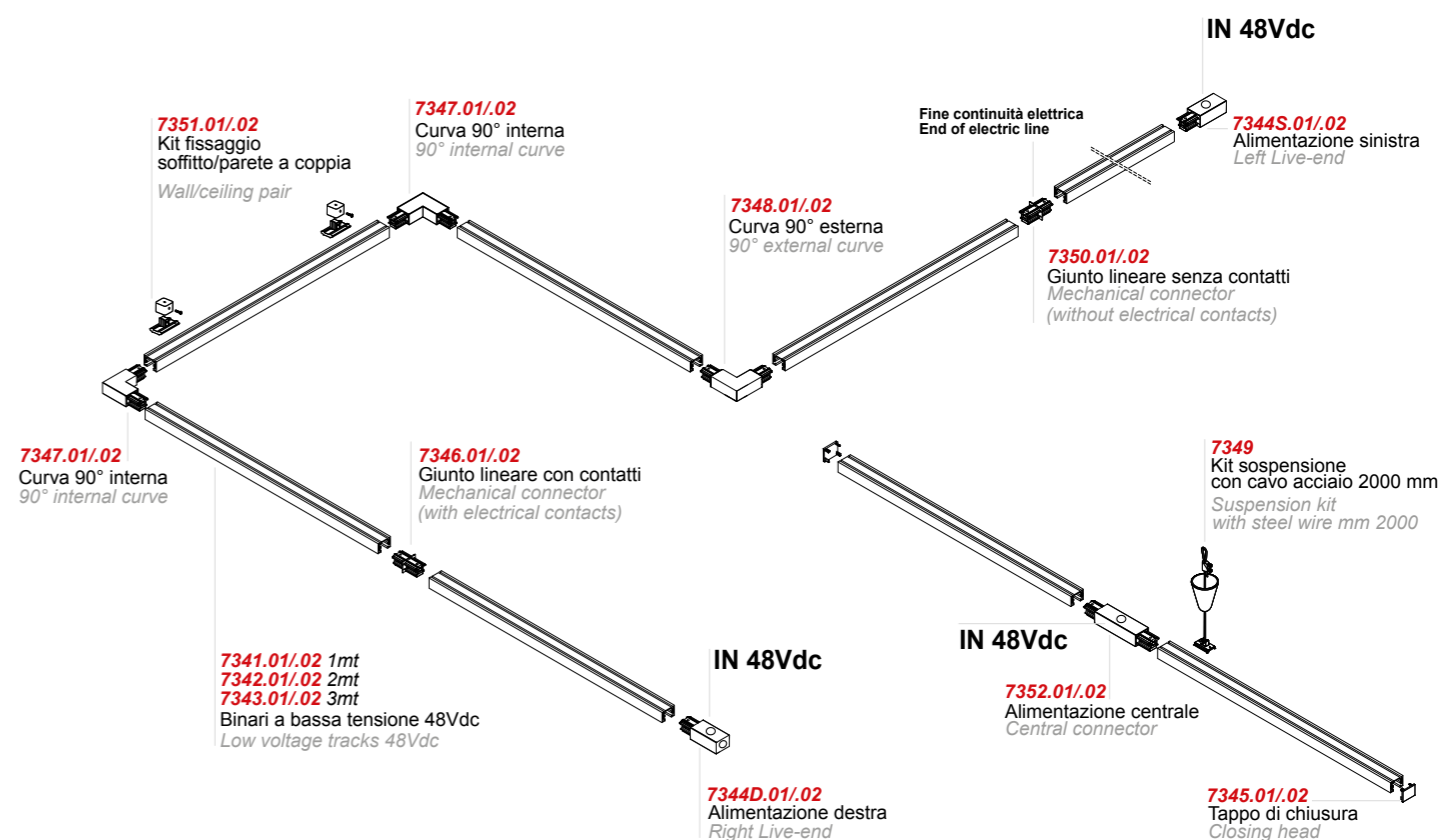

Accessori - Accessories

0160/48
IN: 220 - 240V
OUT: 48V - 50W

1-4 Newton

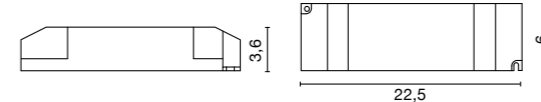

SELV 7 cm.

0157/48
IN: 220 - 240V
OUT: 48V - 70/72W

1-6 Newton

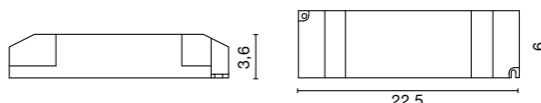

SELV 7 cm.

0162/48
IN: 220 - 240V
OUT: 48V - 150W

1-12 Newton

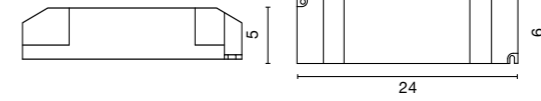

SELV 8 cm.

0715/48.01-.02 Rosone con driver - Ceiling rose with driver

IN: 220 - 240V
OUT: 48V - 60W
ON-OFF
DIM1...10V
DIM PUSH

1-4 Newton

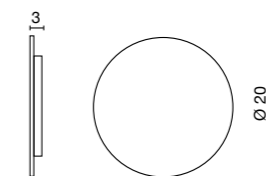

Esempio d'installazione Track 48 + 0715/48.01
Example installation Track 48 + 0715/48.01



Binari elettrificati a bassa tensione 48V per installazioni a incasso trimless in controsoffitti. I due conduttori per 48V portano, a richiesta, anche il segnale DALI consentendo la regolazione dinamica della luce.

48V low voltage electrified tracks for trimless recessed installation in false ceilings. The two 48V conductors can transmit, upon request, also DALI signal, allowing for the light dynamic control.

7361 Binario 48V (20A) 1mt - Track 48V (20A) 1mt
.02 Nero - Black

7362 Binario 48V (20A) 2mt - Track 48V (20A) 2mt
.02 Nero - Black

7363 Binario 48V (20A) 3mt - Track 48V (20A) 3mt
.02 Nero - Black

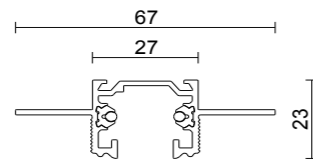

Accessori - Accessories

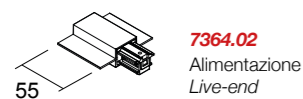

7364.02
Alimentazione
Live-end

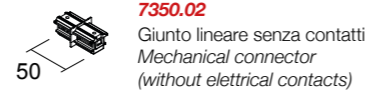

7350.02
Giunto lineare senza contatti
Mechanical connector
(without electrical contacts)

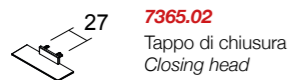

7365.02
Tappo di chiusura
Closing head



7366.02
Alimentazione centrale
Central Connector

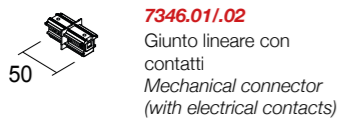

7346.01/.02
Giunto lineare con
contatti
Mechanical connector
(with electrical contacts)

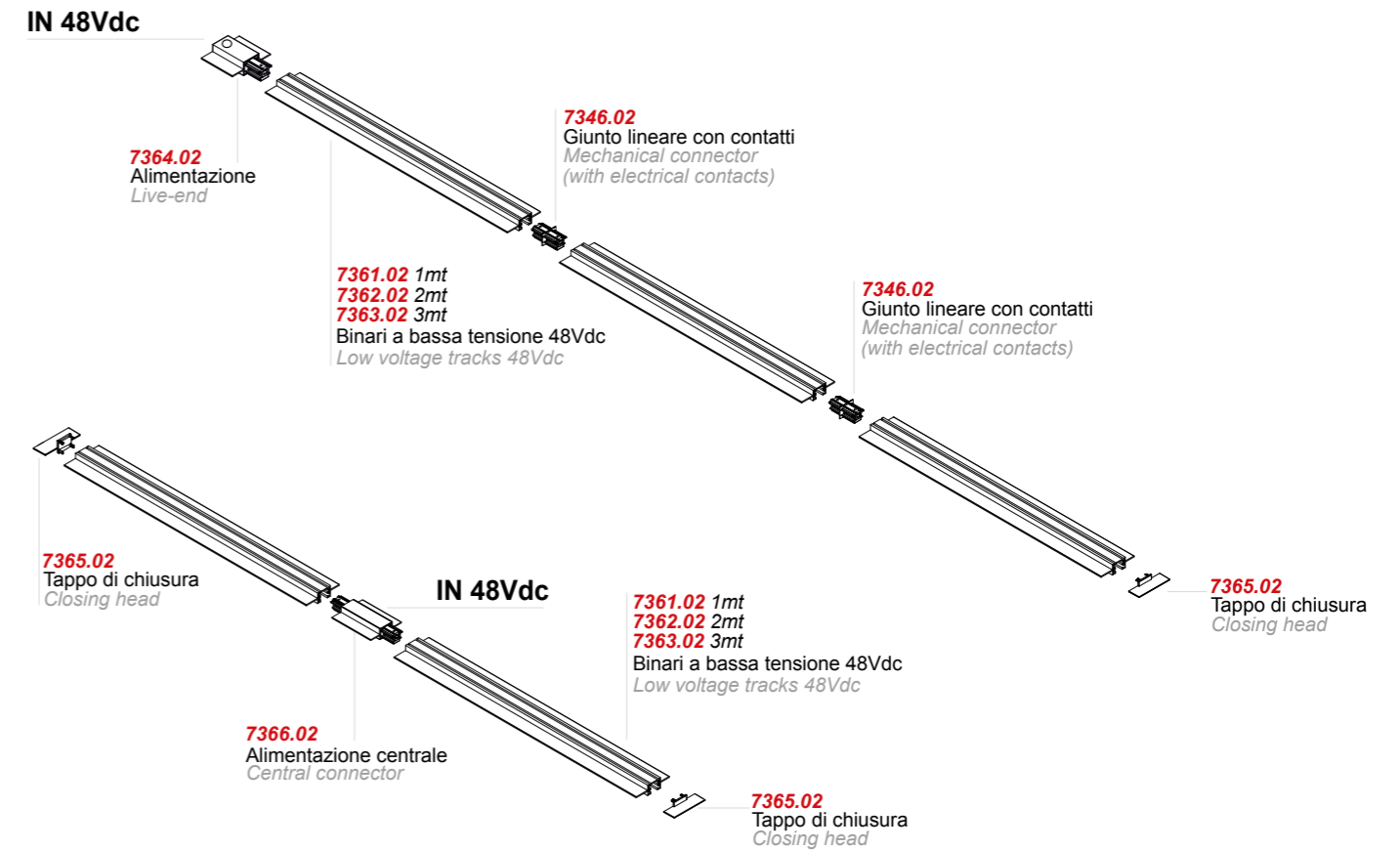

Accessori - Accessories

0160/48
IN: 220 - 240V
OUT: 48V - 50W
1-4 Newton
KEMA SELV 7 cm.

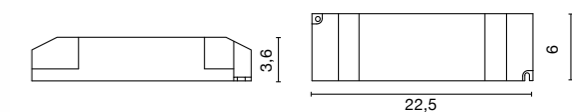

0157/48
IN: 220 - 240V
OUT: 48V - 70/72W
1-6 Newton
KEMA SELV 7 cm.

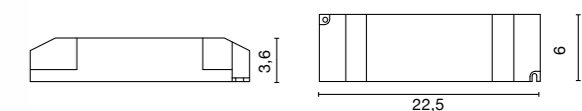

0162/48
IN: 220 - 240V
OUT: 48V - 150W
1-12 Newton
KEMA SELV 8 cm.

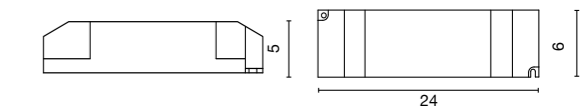



Newton Track 230

Proiettori di dimensioni ridotte realizzati in alluminio verniciato bianco o nero per Binario 230/440V trifase.

Disponibile anche in versione GU10 con diverse finiture

- Dissipazione passiva
- Inclinazione di 90° su piano orizzontale
- Rotazione di 350° su asse verticale.
- Diverse ottiche disponibili.
- Accessori decorativi.
- Accessori ottici.
- Temperature di colore disponibili: 2700, 3000, 4000K.
- Aste di diverse lunghezze.

Small sized projectors made of black or white painted aluminum for 230/440V 3-phase track. Also available with GU10 bulb socket and in more finishes.

- *Passive heatsink*
- *90° regulation on horizontal plan*
- *350° rotation on vertical axis*
- *Different beam and optics solutions*
- *Decorative accessories*
- *Optic accessories*
- *Available light tones: 2700, 3000, 4000K*
- *Different rod lengths*

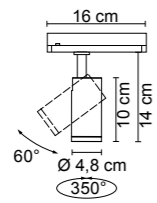
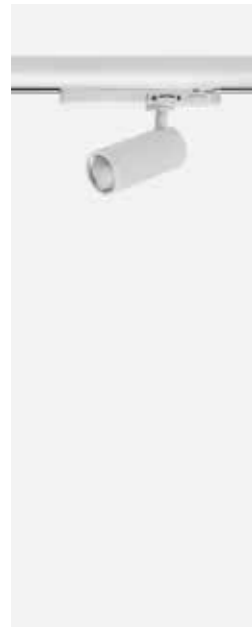

6370 0,55 kg

- .01 Bianco - White
- .02 Nero - Black

LED cod.	OPTIC degree/OPTION	Im	LED color
<i>/W</i>	<i>/24 /38 /58</i>	LED 8,9W 500mA	1353lm 4000K
<i>/W/ST</i>	Vetro satinato - <i>Satin glass</i>	LED 8,9W 500mA 38°	1353lm 4000K
<i>/WW</i>	<i>/24 /38 /58</i>	LED 8,9W 500mA	1303lm 3000K
<i>/WW/ST</i>	Vetro satinato - <i>Satin glass</i>	LED 8,9W 500mA 38°	1303lm 3000K
<i>/XW</i>	<i>/24 /38 /58</i>	LED 8,9W 500mA	1244lm 2700K
<i>/XW/ST</i>	Vetro satinato - <i>Satin glass</i>	LED 8,9W 500mA 38°	1244lm 2700K

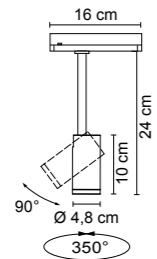

6466 0,65 kg

- .01 Bianco - White
- .02 Nero - Black

LED cod.	OPTIC degree/OPTION	Im	LED color
<i>/W</i>	<i>/24 /38 /58</i>	LED 8,9W 500mA	1353lm 4000K
<i>/W/ST</i>	Vetro satinato - <i>Satin glass</i>	LED 8,9W 500mA 38°	1353lm 4000K
<i>/WW</i>	<i>/24 /38 /58</i>	LED 8,9W 500mA	1303lm 3000K
<i>/WW/ST</i>	Vetro satinato - <i>Satin glass</i>	LED 8,9W 500mA 38°	1303lm 3000K
<i>/XW</i>	<i>/24 /38 /58</i>	LED 8,9W 500mA	1244lm 2700K
<i>/XW/ST</i>	Vetro satinato - <i>Satin glass</i>	LED 8,9W 500mA 38°	1244lm 2700K

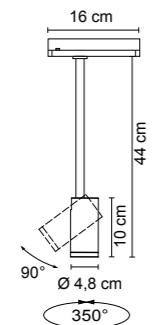

6467 0,75 kg

- .01 Bianco - White
- .02 Nero - Black

LED cod.	OPTIC degree/OPTION	Im	LED color
<i>/W</i>	<i>/24 /38 /58</i>	LED 8,9W 500mA	1353lm 4000K
<i>/W/ST</i>	Vetro satinato - <i>Satin glass</i>	LED 8,9W 500mA 38°	1353lm 4000K
<i>/WW</i>	<i>/24 /38 /58</i>	LED 8,9W 500mA	1303lm 3000K
<i>/WW/ST</i>	Vetro satinato - <i>Satin glass</i>	LED 8,9W 500mA 38°	1303lm 3000K
<i>/XW</i>	<i>/24 /38 /58</i>	LED 8,9W 500mA	1244lm 2700K
<i>/XW/ST</i>	Vetro satinato - <i>Satin glass</i>	LED 8,9W 500mA 38°	1244lm 2700K



Esempio con 0274 - Example with 0274

Ottiche Disponibili - Available Optics



/24
Ottica a fascio stretto per luce d'accento
Narrow beam optic for accent lighting



/58
Ottica fascio largo
Wide beam optic



/38
Ottica fascio medio
Medium beam optic



/ST
Ottica fascio diffuso per illuminazione generale
Diffused light optic for general lighting

Accessori - Accessories



0267.01
Frangiluce
Louvres



0267.02
Frangiluce
Louvres



0274.01
Schermo antiabbagliamento
Anti-glare screen



0274.02
Schermo antiabbagliamento
Anti-glare screen

Newton Slim Track 230

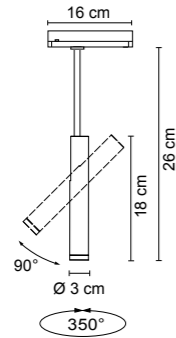
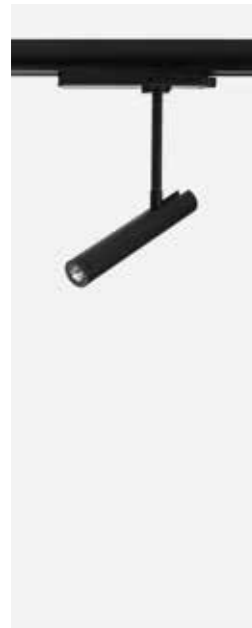

6464 0,50 kg

- .01 Bianco - White
- .02 Nero - Black

LED cod.	OPTIC degree/OPTION		lm	LED color
/W	/35 /48 /63	LED 8,9W 500mA	1353lm	4000K
/W/ST	Vetro satinato - Satin glass	LED 8,9W 500mA 35°	1353lm	4000K
/WW	/35 /48 /63	LED 8,9W 500mA	1303lm	3000K
/WW/ST	Vetro satinato - Satin glass	LED 8,9W 500mA 35°	1303lm	3000K
/XW	/35 /48 /63	LED 8,9W 500mA	1244lm	2700K
/XW/ST	Vetro satinato - Satin glass	LED 8,9W 500mA 35°	1244lm	2700K

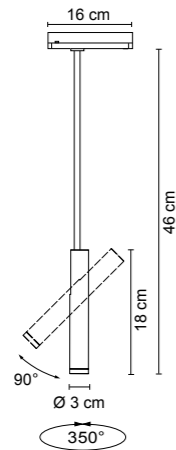

6465 0,60 kg

- .01 Bianco - White
- .02 Nero - Black

LED cod.	OPTIC degree/OPTION		lm	LED color
/W	/35 /48 /63	LED 8,9W 500mA	1353lm	4000K
/W/ST	Vetro satinato - Satin glass	LED 8,9W 500mA 35°	1353lm	4000K
/WW	/35 /48 /63	LED 8,9W 500mA	1303lm	3000K
/WW/ST	Vetro satinato - Satin glass	LED 8,9W 500mA 35°	1303lm	3000K
/XW	/35 /48 /63	LED 8,9W 500mA	1244lm	2700K
/XW/ST	Vetro satinato - Satin glass	LED 8,9W 500mA 35°	1244lm	2700K



Newton Slim Track 230



Esempio con e senza 0265 - Example with or without 0265

Ottiche Disponibili - Available Optics



/35
Ottica a fascio stretto per luce d'accento
Narrow beam optic for accent lighting



/63
Ottica fascio largo
Wide beam optic



/48
Ottica fascio medio
Medium beam optic



/1ST
Ottica fascio diffuso per illuminazione generale
Diffused light optic for general lighting

Accessori - Accessories



0265.01
Diffusore in vetro Pyrex sabbato
Sand blasted Pyrex glass diffuser



0265.02
Diffusore in vetro Pyrex sabbato
Sand blasted Pyrex glass diffuser

Newton Flat Track 230

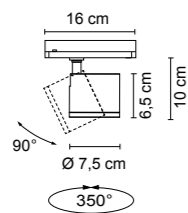
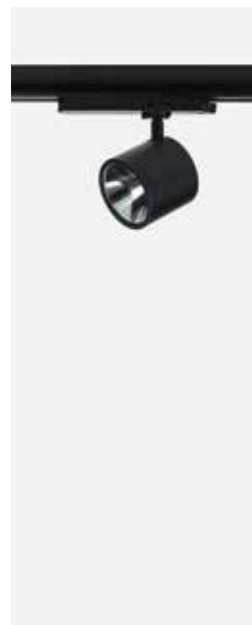

6461 0,60 kg

- .01 Bianco - White
- .02 Nero - Black

LED cod.	OPTIC degree/OPTION		Im	LED color
/W	/13 /40	LED 8,9W 500mA	1353lm	4000K
/W/ST	Vetro satinato - <i>Satin glass</i>	LED 8,9W 500mA 40°	1353lm	4000K
/WW	/13 /40	LED 8,9W 500mA	1303lm	3000K
/WW/ST	Vetro satinato - <i>Satin glass</i>	LED 8,9W 500mA 40°	1303lm	3000K
/XW	/13 /40	LED 8,9W 500mA	1244lm	2700K
/XW/ST	Vetro satinato - <i>Satin glass</i>	LED 8,9W 500mA 40°	1244lm	2700K

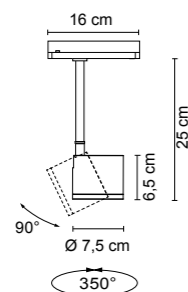

6462 0,70 kg

- .01 Bianco - White
- .02 Nero - Black

LED cod.	OPTIC degree/OPTION		Im	LED color
/W	/13 /40	LED 8,9W 500mA	1353lm	4000K
/W/ST	Vetro satinato - <i>Satin glass</i>	LED 8,9W 500mA 40°	1353lm	4000K
/WW	/13 /40	LED 8,9W 500mA	1303lm	3000K
/WW/ST	Vetro satinato - <i>Satin glass</i>	LED 8,9W 500mA 40°	1303lm	3000K
/XW	/13 /40	LED 8,9W 500mA	1244lm	2700K
/XW/ST	Vetro satinato - <i>Satin glass</i>	LED 8,9W 500mA 40°	1244lm	2700K

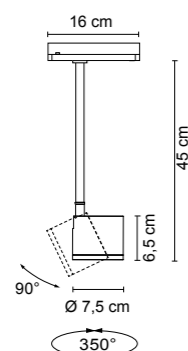

6463 0,80 kg

- .01 Bianco - White
- .02 Nero - Black

LED cod.	OPTIC degree/OPTION		Im	LED color
/W	/13 /40	LED 8,9W 500mA	1353lm	4000K
/W/ST	Vetro satinato - <i>Satin glass</i>	LED 8,9W 500mA 40°	1353lm	4000K
/WW	/13 /40	LED 8,9W 500mA	1303lm	3000K
/WW/ST	Vetro satinato - <i>Satin glass</i>	LED 8,9W 500mA 40°	1303lm	3000K
/XW	/13 /40	LED 8,9W 500mA	1244lm	2700K
/XW/ST	Vetro satinato - <i>Satin glass</i>	LED 8,9W 500mA 40°	1244lm	2700K



Newton Flat Track 230



Esempio con 0264 - Example with 0264

Ottiche Disponibili - Available Optics



/13
Ottica a fascio stretto per luce d'accento
Narrow beam optic for accent lighting

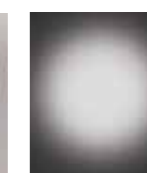

/ST
Ottica fascio diffuso per illuminazione generale
Diffused light optic for general lighting



/40
Ottica fascio largo
Wide beam optic

Accessori - Accessories



0264.01
Parabola decorativa
Decorative parabolic reflector



0264.02
Parabola decorativa
Decorative parabolic reflector

Newton Easy Track 230 - GU10

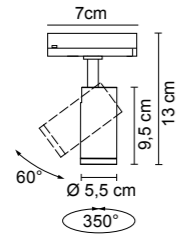
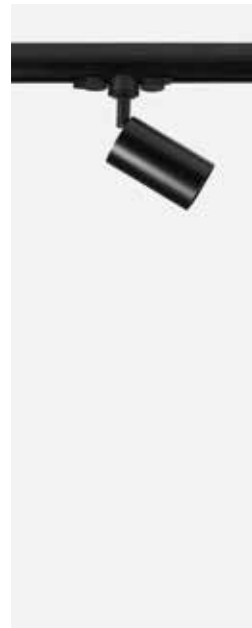

6480 0,40 kg

- .01** Bianco - *White*
 - .02** Nero - *Black*
 - 02.25** Dorato Satinato - *Satin Gold*
 - 02.32** Nickel Satinato - *Nickel Matt*
- 7W GU10 LED (art.0094/16)



02.25 Dorato Satinato - *Satin Gold*



02.32 Nickel Satinato - *Nickel Matt*



.02 Nero - *Black*



.01 Bianco - *White*



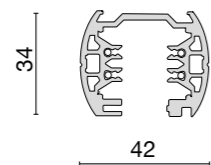

BINARIO elettrificato a tre accensioni diversificate, costruito in lega di alluminio estruso con conduttori in rame alloggiati all'interno di profilati estrusi in PVC.

Electrified TRACK with 3 different switchings, made in extruded aluminium with internal PVC extrusion copper wires.

7321 250/440V 16A 3 mt.
 .01 Bianco - White
 .02 Nero - Black

7322 250/440V 16A 1 mt.
 .01 Bianco - White
 .02 Nero - Black

7323 250/440V 16A 2 mt.
 .01 Bianco - White
 .02 Nero - Black

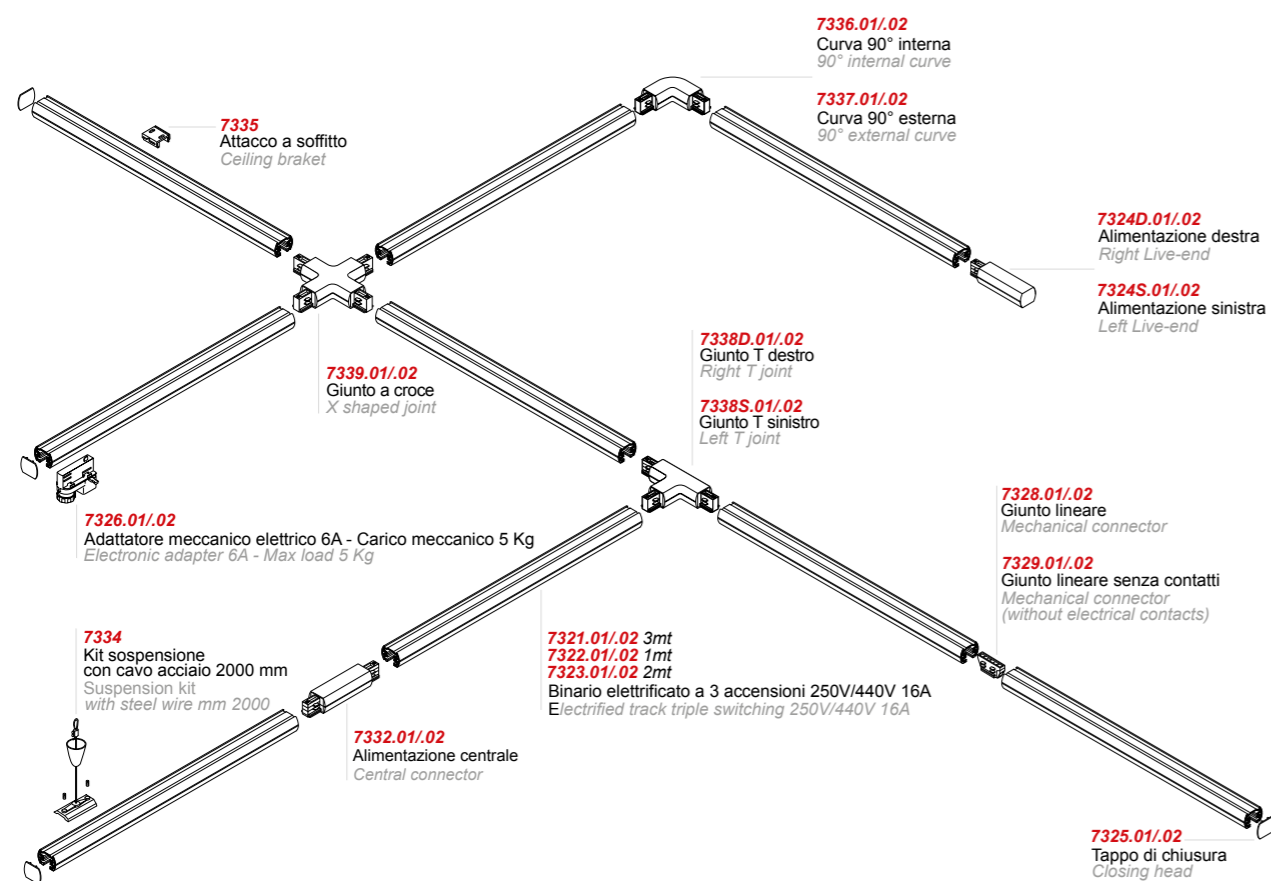

I giunti di collegamento saranno Destro o Sinistro secondo la posizione laterale del contatto di terra.
 Joints will be right(D) or left(S) following the lateral position of earth conductors.

Accessori - Accessories

	7326.01.02 Adattatore meccanico/elettrico 6A Carico meccanico 5 Kg. Mechanical/electrical adapters 6A Mechanical load 5 Kg.		7328.01.02 Giunto lineare. Straight joint.
	7324 D.01.02 Alimentazione destra. Right live-end.		7324 S.01.02 Alimentazione sinistra. Left live-end.
	7325.01.02 Chiusura. Dead end.		7329.01.02 Giunto lineare senza contatti. Mechanical joint without contacts.
	7336.01.02 Giunto L interno. Inside L joint.		7332.01.02 Alimentazione centrale e giunto lineare. Central connector with straight joint.
	7337.01.02 Giunto L esterno. Outside L joint.		7333 Piastra 12cm. Plate 12cm.
	7339.01.02 Giunto X. X joint.		7338 D.01.02 Giunto T destro. Right T joint.
	7331.01.02 Kit per sospensione binario. Kit to suspend track.		7338 S.01.02 Giunto T sinistro. Left T joint.
	7334.01.02 Kit cavo acciaio (2m), piastra 6cm. Kit with steel wire (2m), plate 6cm.		7335 Attacco soffitto kit. Ceiling kit.



NewtonSpots

Faretti da incasso di dimensioni ridotte realizzati in alluminio verniciato bianco o nero. Disponibile anche in versione GU10 con diverse finiture

- Dissipazione passiva
- Inclinazione di 90° sul piano orizzontale
- Rotazione di 350° sull'asse verticale.
- Diverse ottiche disponibili.
- Accessori decorativi.
- Accessori ottici.
- Temperature di colore disponibili: 2700, 3000, 4000K.
- Aste di diverse lunghezze.

Small sized recessed spots made of black or white painted aluminum.

Also available with GU10 bulb socket and in more finishes.

- *Passive heatsink*
- *90° regulation on horizontal plan*
- *350° rotation on vertical axis*
- *Different beam and optics solutions*
- *Decorative accessories*
- *Optic accessories*
- *Available light tones: 2700, 3000, 4000K*
- *Different rod lengths*



Newton Spots

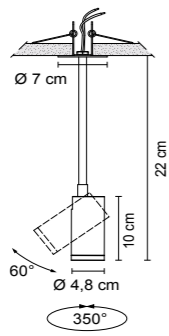
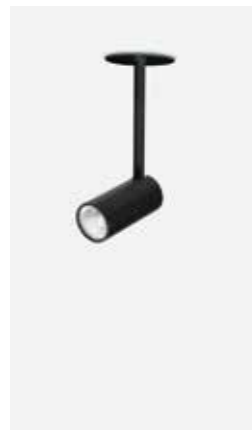

6342 0,55 kg

.01 Bianco - White
.02 Nero - Black

LED cod.	OPTIC degree/OPTION	Im	LED color
/W	/24 /38 /58	LED 8,9W 17,8V 500mA	1353lm 4000K
/W/ST	Vetro satinato - Satin glass	LED 8,9W 17,8V 500mA	38° 1353lm 4000K
/WW	/24 /38 /58	LED 8,9W 17,8V 500mA	1303lm 3000K
/WW/ST	Vetro satinato - Satin glass	LED 8,9W 17,8V 500mA	38° 1303lm 3000K
/XW	/24 /38 /58	LED 8,9W 17,8V 500mA	1244lm 2700K
/XW/ST	Vetro satinato - Satin glass	LED 8,9W 17,8V 500mA	38° 1244lm 2700K

F III 5,1 cm.

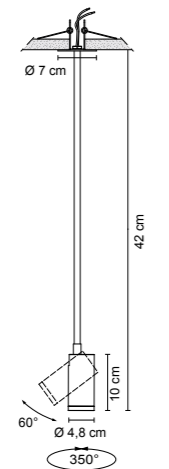

6344 0,60 kg

.01 Bianco - White
.02 Nero - Black

LED cod.	OPTIC degree/OPTION	Im	LED color
/W	/24 /38 /58	LED 8,9W 17,8V 500mA	1353lm 4000K
/W/ST	Vetro satinato - Satin glass	LED 8,9W 17,8V 500mA	38° 1353lm 4000K
/WW	/24 /38 /58	LED 8,9W 17,8V 500mA	1303lm 3000K
/WW/ST	Vetro satinato - Satin glass	LED 8,9W 17,8V 500mA	38° 1303lm 3000K
/XW	/24 /38 /58	LED 8,9W 17,8V 500mA	1244lm 2700K
/XW/ST	Vetro satinato - Satin glass	LED 8,9W 17,8V 500mA	38° 1244lm 2700K

F III 5,1 cm.

Ottiche Disponibili - Available Optics



Accessori - Accessories

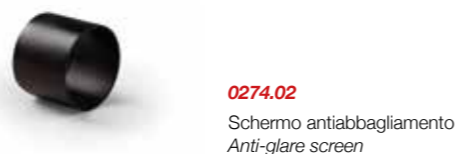
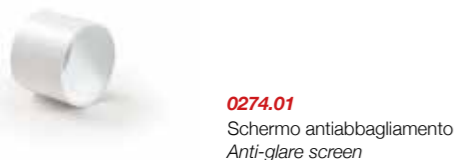

Drivers

Cod. LED	Drivers								
	0125 350mA	0147/COB 500mA	0128 350mA	0129 DIM	0129/DALI DIM DALI	0145 DIM	0145/DALI DIM DALI	0115/EM EMERGENCY	
6342	1	1-2	1-2	1-2	1-2	1-3	1-3	1	
6344	1	1-2	1-2	1-2	1-2	1-3	1-3	1	

Newton Slim Spots

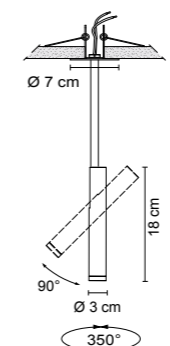

6470 0,55 kg

.01 Bianco - White
.02 Nero - Black

LED cod.	OPTIC degree/OPTION	Im	LED color
/W	/35 /48 /63	LED 8,9W 17,8V 500mA	1353lm 4000K
/W/ST	Vetro satinato - Satin glass	LED 8,9W 17,8V 500mA	35° 1353lm 4000K
/WW	/35 /48 /63	LED 8,9W 17,8V 500mA	1303lm 3000K
/WW/ST	Vetro satinato - Satin glass	LED 8,9W 17,8V 500mA	35° 1303lm 3000K
/XW	/35 /48 /63	LED 8,9W 17,8V 500mA	1244lm 2700K
/XW/ST	Vetro satinato - Satin glass	LED 8,9W 17,8V 500mA	35° 1244lm 2700K

F III 5,1 cm.

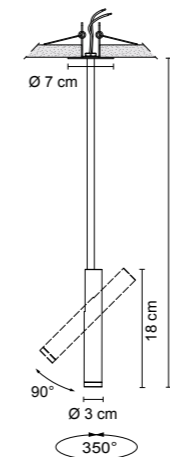

6471 0,60 kg

.01 Bianco - White
.02 Nero - Black

LED cod.	OPTIC degree/OPTION	Im	LED color
/W	/35 /48 /63	LED 8,9W 17,8V 500mA	1353lm 4000K
/W/ST	Vetro satinato - Satin glass	LED 8,9W 17,8V 500mA	35° 1353lm 4000K
/WW	/35 /48 /63	LED 8,9W 17,8V 500mA	1303lm 3000K
/WW/ST	Vetro satinato - Satin glass	LED 8,9W 17,8V 500mA	35° 1303lm 3000K
/XW	/35 /48 /63	LED 8,9W 17,8V 500mA	1244lm 2700K
/XW/ST	Vetro satinato - Satin glass	LED 8,9W 17,8V 500mA	35° 1244lm 2700K

F III 5,1 cm.

Ottiche Disponibili - Available Optics

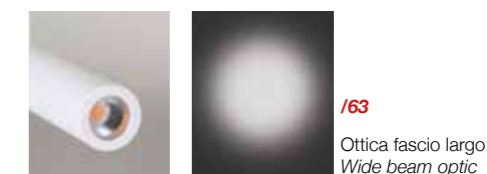
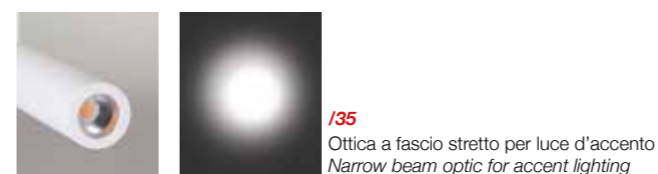

Accessori - Accessories



Drivers

Cod. LED	Drivers								
	0125 350mA	0147/COB 500mA	0128 350mA	0129 DIM	0129/DALI DIM DALI	0145 DIM	0145/DALI DIM DALI	0115/EM EMERGENCY	
6470	1	1-2	1-2	1-2	1-2	1-3	1-3	1	
6471	1	1-2	1-2	1-2	1-2	1-3	1-3	1	

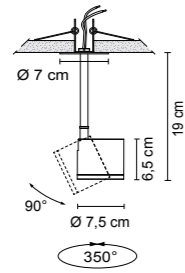
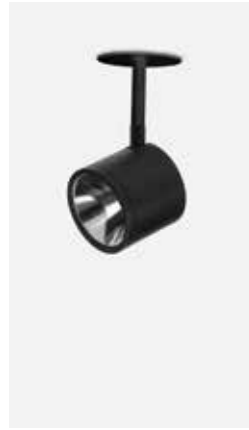

6468 0,60 kg

.01 Bianco - White
.02 Nero - Black

LED cod.	OPTIC degree/OPTION	Im	LED color
/W	/13 /40	LED 8,9W 17,8V 500mA	1353lm 4000K
/W/ST	Vetro satinato - Satin glass	LED 8,9W 17,8V 500mA	40° 1353lm 4000K
/WW	/13 /40	LED 8,9W 17,8V 500mA	1303lm 3000K
/WW/ST	Vetro satinato - Satin glass	LED 8,9W 17,8V 500mA	40° 1303lm 3000K
/XW	/13 /40	LED 8,9W 17,8V 500mA	1244lm 2700K
/XW/ST	Vetro satinato - Satin glass	LED 8,9W 17,8V 500mA	40° 1244lm 2700K

F III 5,1 cm.

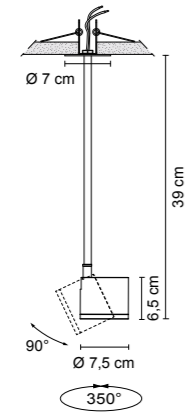

6469 0,70 kg

.01 Bianco - White
.02 Nero - Black

LED cod.	OPTIC degree/OPTION	Im	LED color
/W	/13 /40	LED 8,9W 17,8V 500mA	1353lm 4000K
/W/ST	Vetro satinato - Satin glass	LED 8,9W 17,8V 500mA	40° 1353lm 4000K
/WW	/13 /40	LED 8,9W 17,8V 500mA	1303lm 3000K
/WW/ST	Vetro satinato - Satin glass	LED 8,9W 17,8V 500mA	40° 1303lm 3000K
/XW	/13 /40	LED 8,9W 17,8V 500mA	1244lm 2700K
/XW/ST	Vetro satinato - Satin glass	LED 8,9W 17,8V 500mA	40° 1244lm 2700K

F III 5,1 cm.

Ottiche Disponibili - Available Optics



/13
Ottica a fascio stretto per luce d'accento
Narrow beam optic for accent lighting



/1ST
Ottica fascio diffuso per illuminazione generale
Diffused light optic for general lighting



/40
Ottica fascio largo
Wide beam optic

Accessori - Accessories



0264.01
Parabola decorativa
Decorative parabolic reflector



0264.02
Parabola decorativa
Decorative parabolic reflector

Drivers

Cod. LED	Drivers							
	0125 350mA	0147/COB 500mA	0128 350mA	0129 DIM	0129/DALI DIM DALI	0145 DIM	0145/DALI DIM DALI	0115/EM EMERGENCY
6468	1	1-2	1-2	1-2	1-2	1-3	1-3	1
6469	1	1-2	1-2	1-2	1-2	1-3	1-3	1

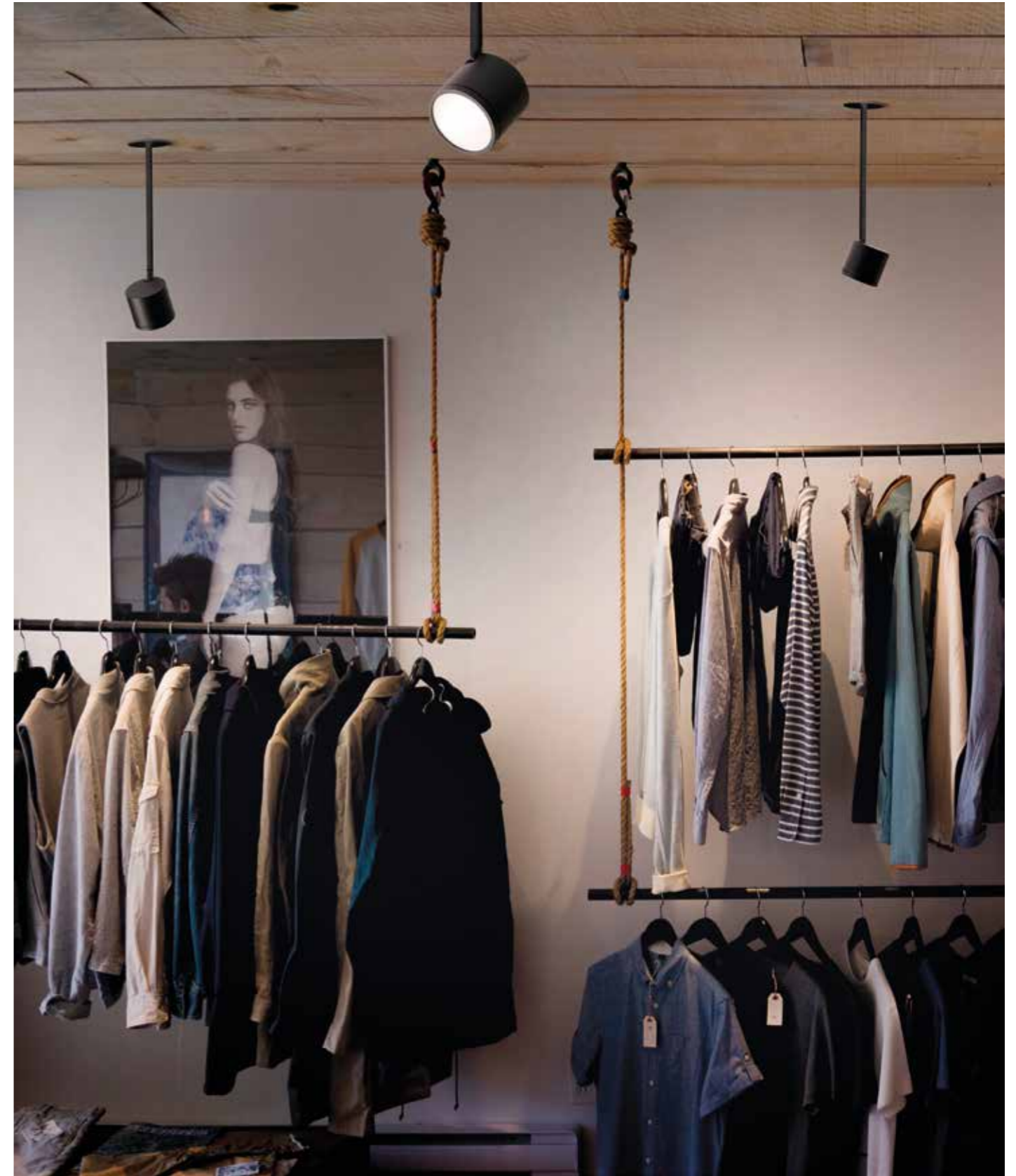

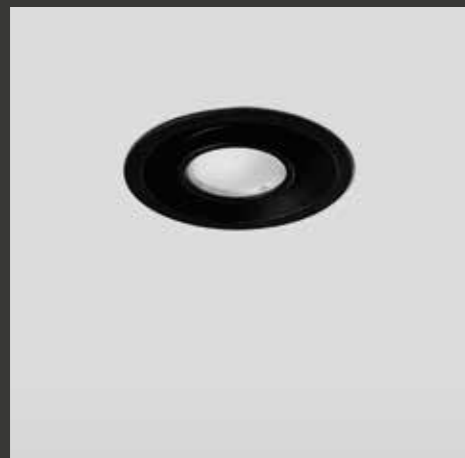

Newton Spot Recessed

Faretto da incasso di dimensioni ridotte realizzato in alluminio verniciato bianco o nero.

- Dissipazione passiva
- Inclinazione di 90° sul piano orizzontale
- Rotazione di 350° sull'asse verticale
- Diverse ottiche disponibili
- Accessori decorativi
- Accessori ottici
- Temperature di colore disponibili: 2700, 3000, 4000K.

Small sized recessed spot made of black or white painted aluminum.

- *Passive heatsink*
- *90° regulation on horizontal plan*
- *350° rotation on vertical axis*
- *Different beam and optics solutions*
- *Decorative accessories*
- *Optic accessories*
- *Available light tones: 2700, 3000, 4000K.*

Newton Spot Recessed

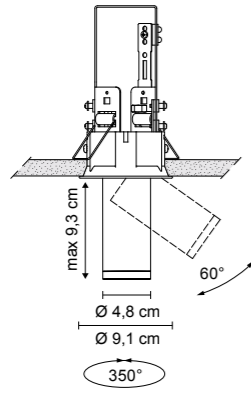
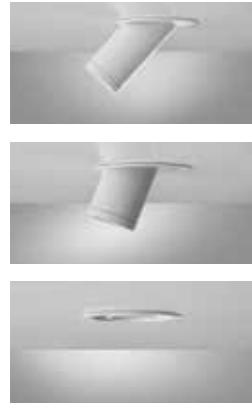

6328 0,8 kg

.01 Bianco - White
.02 Nero - Black

LED cod.	OPTIC degree/OPTION	Im	LED color
/W	/24 /38 /58	LED 8,9W 17,8V 500mA	1353lm 4000K
/W/ST	Vetro satinato - Satin glass	LED 8,9W 17,8V 500mA	38° 1353lm 4000K
/WW	/24 /38 /58	LED 8,9W 17,8V 500mA	1303lm 3000K
/WW/ST	Vetro satinato - Satin glass	LED 8,9W 17,8V 500mA	38° 1303lm 3000K
/XW	/24 /38 /58	LED 8,9W 17,8V 500mA	1244lm 2700K
/XW/ST	Vetro satinato - Satin glass	LED 8,9W 17,8V 500mA	38° 1244lm 2700K

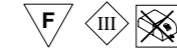

8,6 cm.

Ottiche Disponibili - Available Optics



/24
Ottica a fascio stretto per luce d'accento
Narrow beam optic for accent lighting



/58
Ottica fascio largo
Wide beam optic



/38
Ottica fascio medio
Medium beam optic



/ST
Ottica fascio diffuso per illuminazione generale
Diffused light optic for general lighting

Accessori - Accessories



0267.01
Frangiluce
Louvres



0267.02
Frangiluce
Louvres



0274.01
Schermo antiabbagliamento
Anti-glare screen



0274.02
Schermo antiabbagliamento
Anti-glare screen

Drivers

Cod. LED	Drivers	0125 350mA	0147/COB 500mA	0128 350mA	0129 DIM	0129/DALI DIM DALI	0145 DIM	0145/DALI DIM DALI	0115/EM EMERGENCY
6328	1	1-2	1-2	1-2	1-2	1-2	1-3	1-3	1



Esempio: /ST - Example: /ST

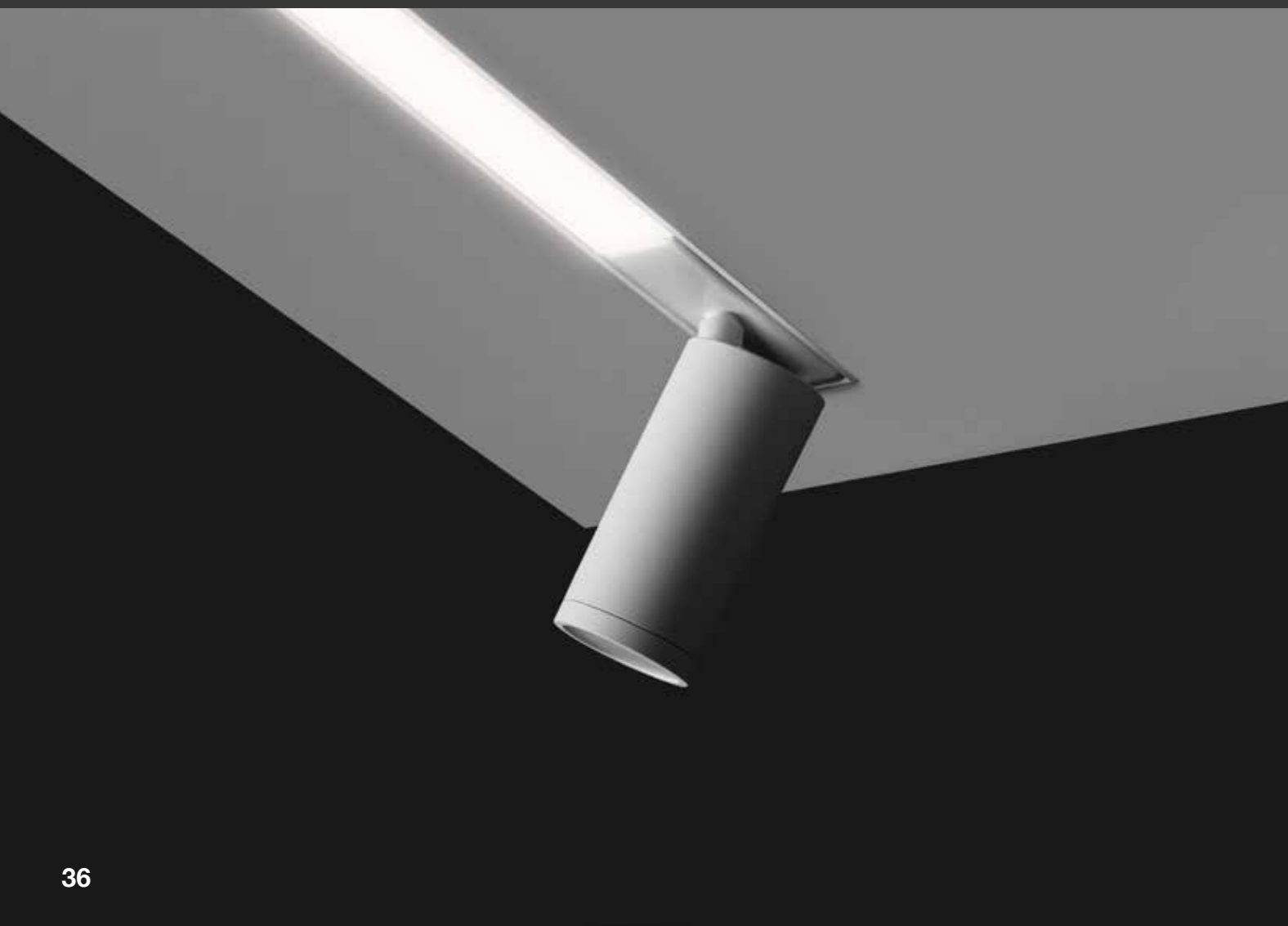

Newton**Rail**

Proiettore di dimensioni ridotte da integrare nel sistema RAIL, realizzati in alluminio verniciato bianco o nero.

- Dissipazione passiva
- Inclinazione di 90° su piano orizzontale
- Rotazione di 350° su asse verticale.
- Diverse ottiche disponibili.
- Accessori decorativi.
- Accessori ottici.
- Temperature di colore disponibili: 2700,3000,4000K.

Small sized projectors to be integrated into RAIL linear profile made of black or white painted aluminum.

- *Passive heatsink*
- *90° regulation on horizontal plan*
- *350° rotation on vertical axis*
- *Different beam and optics solutions*
- *Decorative accessories*
- *Optic accessories*
- *Available light tones: 2700, 3000, 4000K*

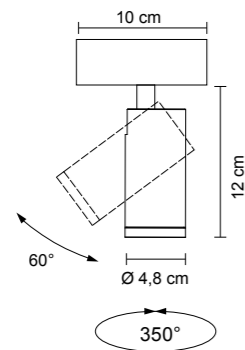
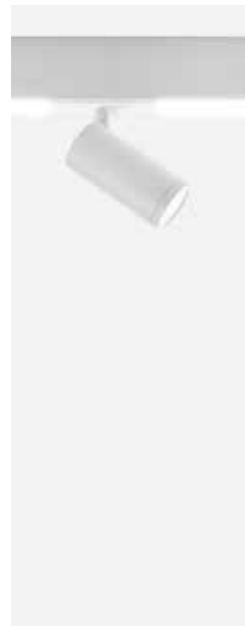

6347 0,50 kg

.01 Bianco - *White*
.02 Nero - *Black*

LED cod.	OPTIC degree/OPTION	Im	LED color
/W	/24 /38 /58	LED 8,9W 17,8V 500mA	1353lm 4000K
/W/ST	Vetro satinato - <i>Satin glass</i>	LED 8,9W 17,8V 500mA	38° 1353lm 4000K
/WW	/24 /38 /58	LED 8,9W 17,8V 500mA	1303lm 3000K
/WW/ST	Vetro satinato - <i>Satin glass</i>	LED 8,9W 17,8V 500mA	38° 1303lm 3000K
/XW	/24 /38 /58	LED 8,9W 17,8V 500mA	1244lm 2700K
/XW/ST	Vetro satinato - <i>Satin glass</i>	LED 8,9W 17,8V 500mA	38° 1244lm 2700K



Ottiche Disponibili - Available Optics

		/24 Ottica a fascio stretto per luce d'accento <i>Narrow beam optic for accent lighting</i>			/58 Ottica fascio largo <i>Wide beam optic</i>
		/38 Ottica fascio medio <i>Medium beam optic</i>			/ST Ottica fascio diffuso per illuminazione generale <i>Diffused light optic for general lighting</i>



Esempio rail sospensione 1543 + Newton 6347 - *Example rail suspension 1543 + Newton 6347*

Accessori - Accessories



0267.01
Frangiluce
Louvres



0267.02
Frangiluce
Louvres

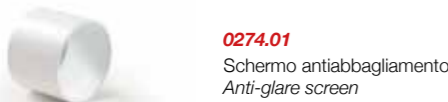

0274.01
Schermo antiabbagliamento
Anti-glare screen

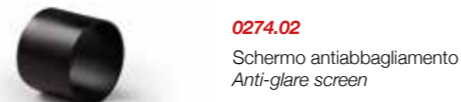

0274.02
Schermo antiabbagliamento
Anti-glare screen

Drivers

- Newton/Rail incasso - *Newton/Rail recessed*

Cod. LED	Drivers	0147/COB	0128	0129	0129/DALI	0145	0145/DALI	0115/EM
	0125 350mA	500mA	350mA	DIM	DIM DALI	DIM	DIM DALI	EMERGENCY
6347	1	1-2	1-2	1-2	1-2	1-3	1-3	1

- Newton/Rail sospensione e plafone/parete: Compresi - *Newton/Rail suspension, ceiling and wall: included*

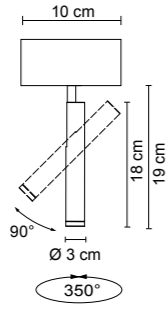

6474		0,50 kg
.01	Bianco - <i>White</i>	
.02	Nero - <i>Black</i>	

LED cod.	OPTIC degree/OPTION	Im	LED color
/W	/35 /48 /63	LED 8,9W 17,8V 500mA	1353lm 4000K
/W/ST	Vetro satinato - <i>Satin glass</i>	LED 8,9W 17,8V 500mA	35° 1353lm 4000K
/WW	/35 /48 /63	LED 8,9W 17,8V 500mA	1303lm 3000K
/WW/ST	Vetro satinato - <i>Satin glass</i>	LED 8,9W 17,8V 500mA	35° 1303lm 3000K
/XW	/35 /48 /63	LED 8,9W 17,8V 500mA	1244lm 2700K
/XW/ST	Vetro satinato - <i>Satin glass</i>	LED 8,9W 17,8V 500mA	35° 1244lm 2700K



Ottiche Disponibili - Available Optics



Accessori - Accessories



Drivers

- Newton/Rail incasso - *Newton/Rail recessed*

Cod. LED	Drivers	0125	0147/COB	0128	0129	0129/DALI	0145	0145/DALI	0115/EM
		350mA	500mA	350mA	DIM	DIM DALI	DIM	DIM DALI	EMERGENCY
6474	1	1-2	1-2	1-2	1-2	1-2	1-3	1-3	1

- Newton/Rail sospensione e plafone/parete: Compresi - *Newton/Rail suspension, ceiling and wall: included*



Esempio rail soffitto 5542 + Newton 6474 - *Example rail ceiling 5542 + Newton 6474*

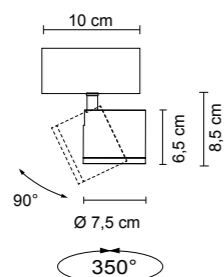

6475 0,55 kg

- .01 Bianco - White
- .02 Nero - Black

LED cod.	OPTIC degree/OPTION	Im	LED color
/W	/13 /40	LED 8,9W 17,8V 500mA	1353lm 4000K
/W/ST	Vetro satinato - Satin glass	LED 8,9W 17,8V 500mA	40° 1353lm 4000K
/WW	/13 /40	LED 8,9W 17,8V 500mA	1303lm 3000K
/WW/ST	Vetro satinato - Satin glass	LED 8,9W 17,8V 500mA	40° 1303lm 3000K
/XW	/13 /40	LED 8,9W 17,8V 500mA	1244lm 2700K
/XW/ST	Vetro satinato - Satin glass	LED 8,9W 17,8V 500mA	40° 1244lm 2700K



Ottiche Disponibili - Available Optics



/13
Ottica a fascio stretto per luce d'accento
Narrow beam optic for accent lighting



/ST
Ottica fascio diffuso per illuminazione generale
Diffused light optic for general lighting



/40
Ottica fascio largo
Wide beam optic

Accessori - Accessories



0264.01
Parabola decorativa
Decorative parabolic reflector



0264.02
Parabola decorativa
Decorative parabolic reflector

Drivers

- Newton/Rail incasso - Newton/Rail recessed

Cod. LED	Drivers	0125 350mA	0147/COB 500mA	0128 350mA	0129 DIM	0129/DALI DIM DALI	0145 DIM	0145/DALI DIM DALI	0115/EM EMERGENCY
6475	1	1-2	1-2	1-2	1-2	1-2	1-3	1-3	1

- Newton/Rail sospensione e plafone/parete: Compresi - Newton/Rail suspension, ceiling and wall: included

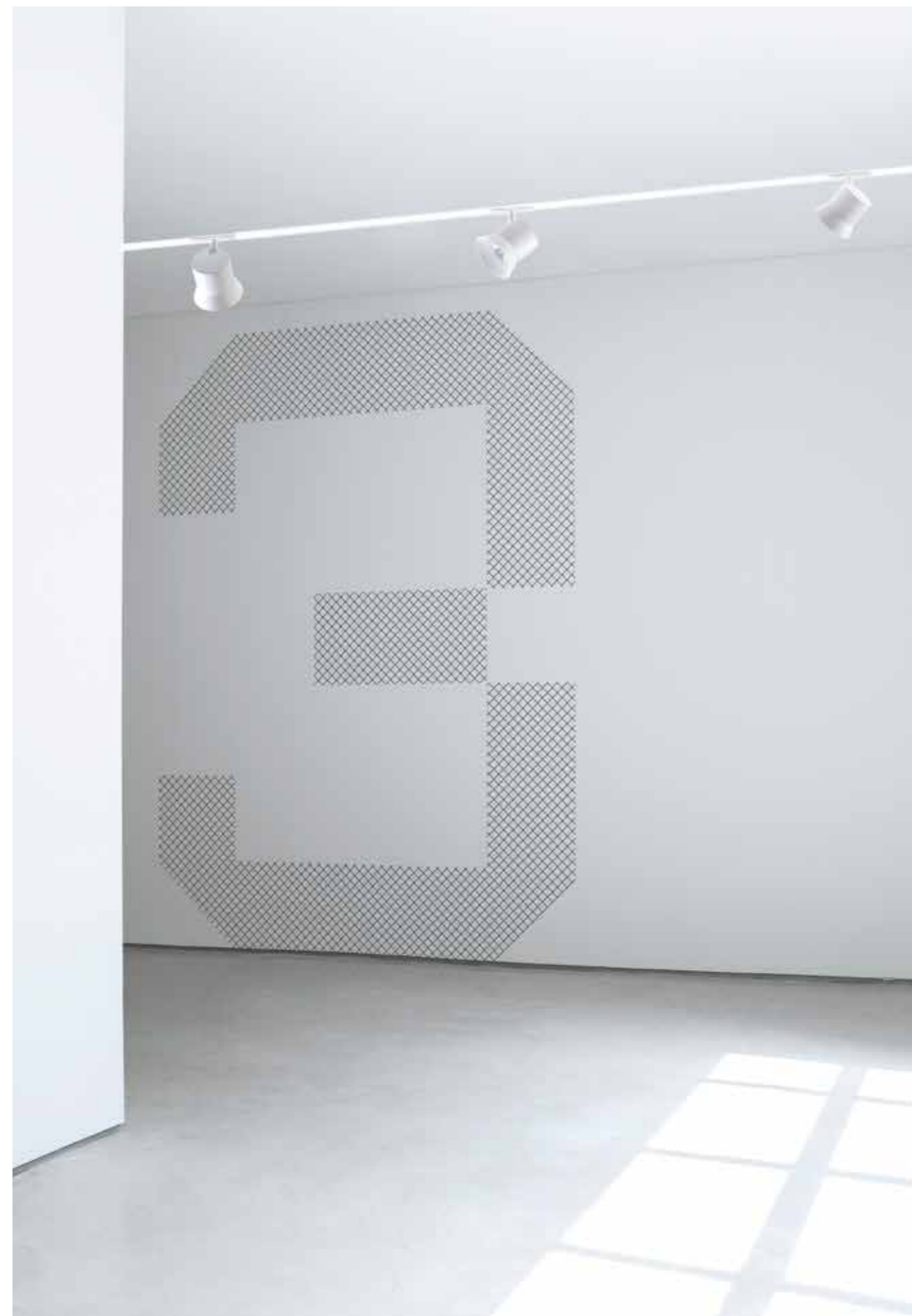

Esempio rail incasso 6660 + Newton 6475 + Parabola decorativa 0264.01 - Example rail recessed 5542 + Newton 6475 + Decorativ parabolic reflector 0264.01

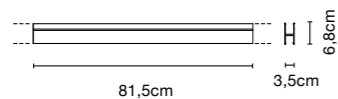

5542 1,1 kg

/XW Led 12W 1424lm 2700K

/WW Led 12W 1520lm 3000K

/W Led 12W 1600lm 4000K



.01/XW .01/WW .01/W

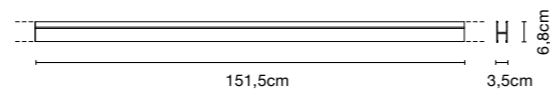

5543 1,5 kg

/XW Led 22,5W 2670lm 2700K

/WW Led 22,5W 2850lm 3000K

/W Led 22,5W 3000lm 4000K



.01/XW .01/WW .01/W

CUSTOM SIZE - Tabella lunghezze disponibili a richiesta. *Table of available lengths on request.*

cm.	watt	2700K (XW)	lm	3000K (WW)	lm	4000K (W)	lm
61,5	9W	A5542.01/60/XW	1068	A5542.01/60/WW	1140	A5542.01/60/W	1200
71,5	10,5W	A5542.01/70/XW	1246	A5542.01/70/WW	1330	A5542.01/70/W	1400
* 81,5	12W	5542.01/XW	1424	5542.01/WW	1520	5542.01/W	1600
91,5	13,5W	A5542.01/90/XW	1602	A5542.01/90/WW	1710	A5542.01/90/W	1800
101,5	15W	A5542.01/100/XW	1780	A5542.01/100/WW	1900	A5542.01/100/W	2000
111,5	16,5W	A5542.01/110/XW	1958	A5542.01/110/WW	2090	A5542.01/110/W	2200
121,5	18W	A5542.01/120/XW	2136	A5542.01/120/WW	2280	A5542.01/120/W	2400
131,5	19,5W	A5542.01/130/XW	2314	A5542.01/130/WW	2470	A5542.01/130/W	2600
141,5	21W	A5542.01/140/XW	2492	A5542.01/140/WW	2660	A5542.01/140/W	2800
* 151,5	22,5W	5543.01/XW	2670	5543.01/WW	2850	5543.01/W	3000
161,5	24W	A5542.01/160/XW	2848	A5542.01/160/WW	3040	A5542.01/160/W	3200
171,5	25,5W	A5542.01/170/XW	3026	A5542.01/170/WW	3230	A5542.01/170/W	3400
181,5	27W	A5542.01/180/XW	3204	A5542.01/180/WW	3420	A5542.01/180/W	3600
191,5	28,5W	A5542.01/190/XW	3382	A5542.01/190/WW	3618	A5542.01/190/W	3800
201,5	30W	A5542.01/200/XW	3560	A5542.01/200/WW	3800	A5542.01/200/W	4000
211,5	31,5W	A5542.01/210/XW	3738	A5542.01/210/WW	3990	A5542.01/210/W	4200
221,5	33W	A5542.01/220/XW	3916	A5542.01/220/WW	4180	A5542.01/220/W	4400
231,5	34,5W	A5542.01/230/XW	4094	A5542.01/230/WW	4370	A5542.01/230/W	4600
241,5	36W	A5542.01/240/XW	4272	A5542.01/240/WW	4560	A5542.01/240/W	4800
251,5	37,5W	A5542.01/250/XW	4450	A5542.01/250/WW	4750	A5542.01/250/W	5000
261,5	39W	A5542.01/260/XW	4628	A5542.01/260/WW	4940	A5542.01/260/W	5200
271,5	40,5W	A5542.01/270/XW	4806	A5542.01/270/WW	5130	A5542.01/270/W	5400
281,5	42W	A5542.01/280/XW	4984	A5542.01/280/WW	5320	A5542.01/280/W	5600
291,5	43,5W	A5542.01/290/XW	5162	A5542.01/290/WW	5510	A5542.01/290/W	5800
301,5	45W	A5542.01/300/XW	5340	A5542.01/300/WW	5700	A5542.01/300/W	6000

* Articolo standard a catalogo - *Standard catalogue item*



Angolo 90° - 90° Corner

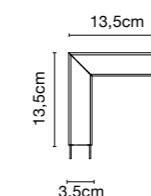

0941 0,4 kg

/XW Led 3W 356lm 2700K

/WW Led 3W 380lm 3000K

/W Led 3W 400lm 4000K



.01/XW .01/WW .01/W



Giunzione a T - T joint

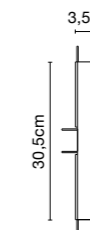

0942 0,35kg

/XW Led 4,5W 534lm 2700K

/WW Led 4,5W 570lm 3000K

/W Led 4,5W 600lm 4000K



.01/XW .01/WW .01/W



Giunzione a croce - Cross joint

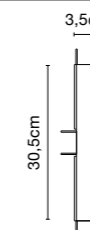

0943 0,35 kg

/XW Led 4,5W 534lm 2700K

/WW Led 4,5W 570lm 3000K

/W Led 4,5W 600lm 4000K



.01/XW .01/WW .01/W



Raccordo parete - Plafone
Wall - Ceiling joint



0944 0,15 kg

.01



2 testate di chiusura.
2 closing heads.

0945

.01



Diffusore - Diffuser

0948/100

L. 100cm

0948/200

L. 200cm

0948/300

L. 300cm

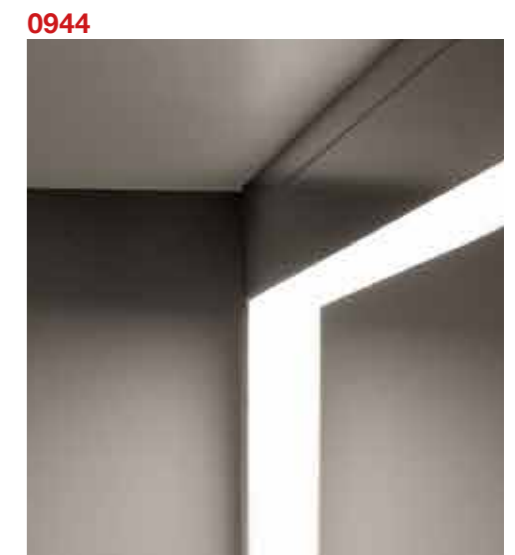
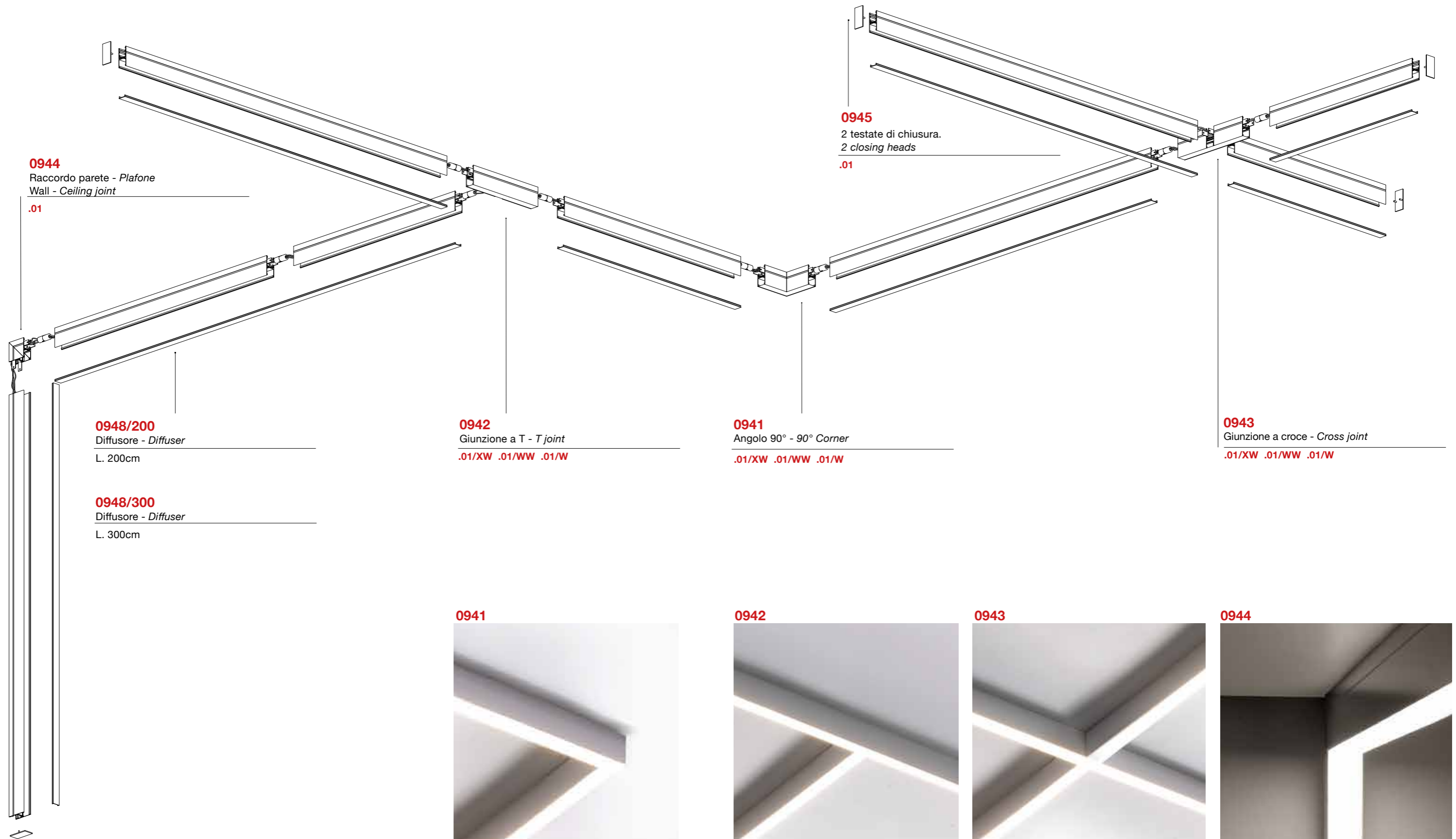

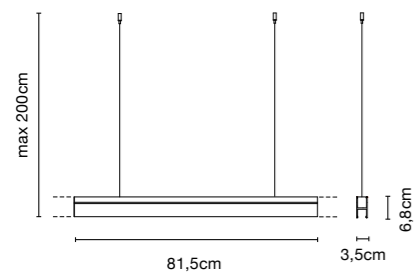

1543 1 kg

/XW Led 12W 1424lm 2700K

/WW Led 12W 1520lm 3000K

/W Led 12W 1600lm 4000K

F IP 40

.01/XW .01/WW .01/W



1544 1,4 kg

/XW Led 22,5W 2670lm 2700K

/WW Led 22,5W 2850lm 3000K

/W Led 22,5W 3000lm 4000K

F IP 40

.01/XW .01/WW .01/W

CUSTOM SIZE - Tabella lunghezze disponibili a richiesta. Table of available lengths on request.

cm.	watt	2700K (XW)	lm	3000K (WW)	lm	4000K (W)	lm
61,5	9W	A1543.01/60/XW	1068	A1543.01/60/WW	1140	A1543.01/60/W	1200
71,5	10,5W	A1543.01/70/XW	1246	A1543.01/70/WW	1330	A1543.01/70/W	1400
★ 81,5	12W	1543.01/XW	1424	1543.01/WW	1520	1543.01/W	1600
91,5	13,5W	A1543.01/90/XW	1602	A1543.01/90/WW	1710	A1543.01/90/W	1800
101,5	15W	A1543.01/100/XW	1780	A1543.01/100/WW	1900	A1543.01/100/W	2000
111,5	16,5W	A1543.01/110/XW	1958	A1543.01/110/WW	2090	A1543.01/110/W	2200
121,5	18W	A1543.01/120/XW	2136	A1543.01/120/WW	2280	A1543.01/120/W	2400
131,5	19,5W	A1543.01/130/XW	2314	A1543.01/130/WW	2470	A1543.01/130/W	2600
141,5	21W	A1543.01/140/XW	2492	A1543.01/140/WW	2660	A1543.01/140/W	2800
★ 151,5	22,5W	1544.01/XW	2670	1544.01/WW	2850	1544.01/W	3000
161,5	24W	A1543.01/160/XW	2848	A1543.01/160/WW	3040	A1543.01/160/W	3200
171,5	25,5W	A1543.01/170/XW	3026	A1543.01/170/WW	3230	A1543.01/170/W	3400
181,5	27W	A1543.01/180/XW	3204	A1543.01/180/WW	3420	A1543.01/180/W	3600
191,5	28,5W	A1543.01/190/XW	3382	A1543.01/190/WW	3618	A1543.01/190/W	3800
201,5	30W	A1543.01/200/XW	3560	A1543.01/200/WW	3800	A1543.01/200/W	4000
211,5	31,5W	A1543.01/210/XW	3738	A1543.01/210/WW	3990	A1543.01/210/W	4200
221,5	33W	A1543.01/220/XW	3916	A1543.01/220/WW	4180	A1543.01/220/W	4400
231,5	34,5W	A1543.01/230/XW	4094	A1543.01/230/WW	4370	A1543.01/230/W	4600
241,5	36W	A1543.01/240/XW	4272	A1543.01/240/WW	4560	A1543.01/240/W	4800
251,5	37,5W	A1543.01/250/XW	4450	A1543.01/250/WW	4750	A1543.01/250/W	5000
261,5	39W	A1543.01/260/XW	4628	A1543.01/260/WW	4940	A1543.01/260/W	5200
271,5	40,5W	A1543.01/270/XW	4806	A1543.01/270/WW	5130	A1543.01/270/W	5400
281,5	42W	A1543.01/280/XW	4984	A1543.01/280/WW	5320	A1543.01/280/W	5600
291,5	43,5W	A1543.01/290/XW	5162	A1543.01/290/WW	5510	A1543.01/290/W	5800
301,5	45W	A1543.01/300/XW	5340	A1543.01/300/WW	5700	A1543.01/300/W	6000

★ Articolo standard a catalogo - Standard catalogue item



Angolo 90° - 90° Corner

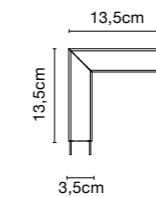

0941 0,4 kg

/XW Led 3W 356lm 2700K

/WW Led 3W 380lm 3000K

/W Led 3W 400lm 4000K

F

.01/XW .01/WW .01/W



Giunzione a T - T joint

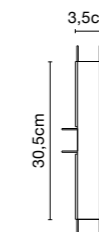

0942 0,35kg

/XW Led 4,5W 534lm 2700K

/WW Led 4,5W 570lm 3000K

/W Led 4,5W 600lm 4000K

F

.01/XW .01/WW .01/W



Giunzione a croce - Cross joint

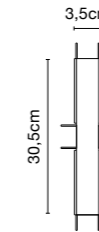

0943 0,35 kg

/XW Led 4,5W 534lm 2700K

/WW Led 4,5W 570lm 3000K

/W Led 4,5W 600lm 4000K

F

.01/XW .01/WW .01/W



Raccordo parete - Plafone
Wall - Ceiling joint

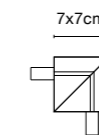

0944 0,15 kg

.01



2 testate di chiusura.
2 closing heads.

0945
.01



Rosone completo di cavo
di alimentazione
Ceiling rose with
cable

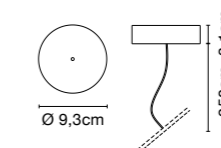

0946 0,08 kg

.01



Diffusore - Diffuser

0948/100

L. 100cm

0948/200

L. 200cm

0948/300

L. 300cm

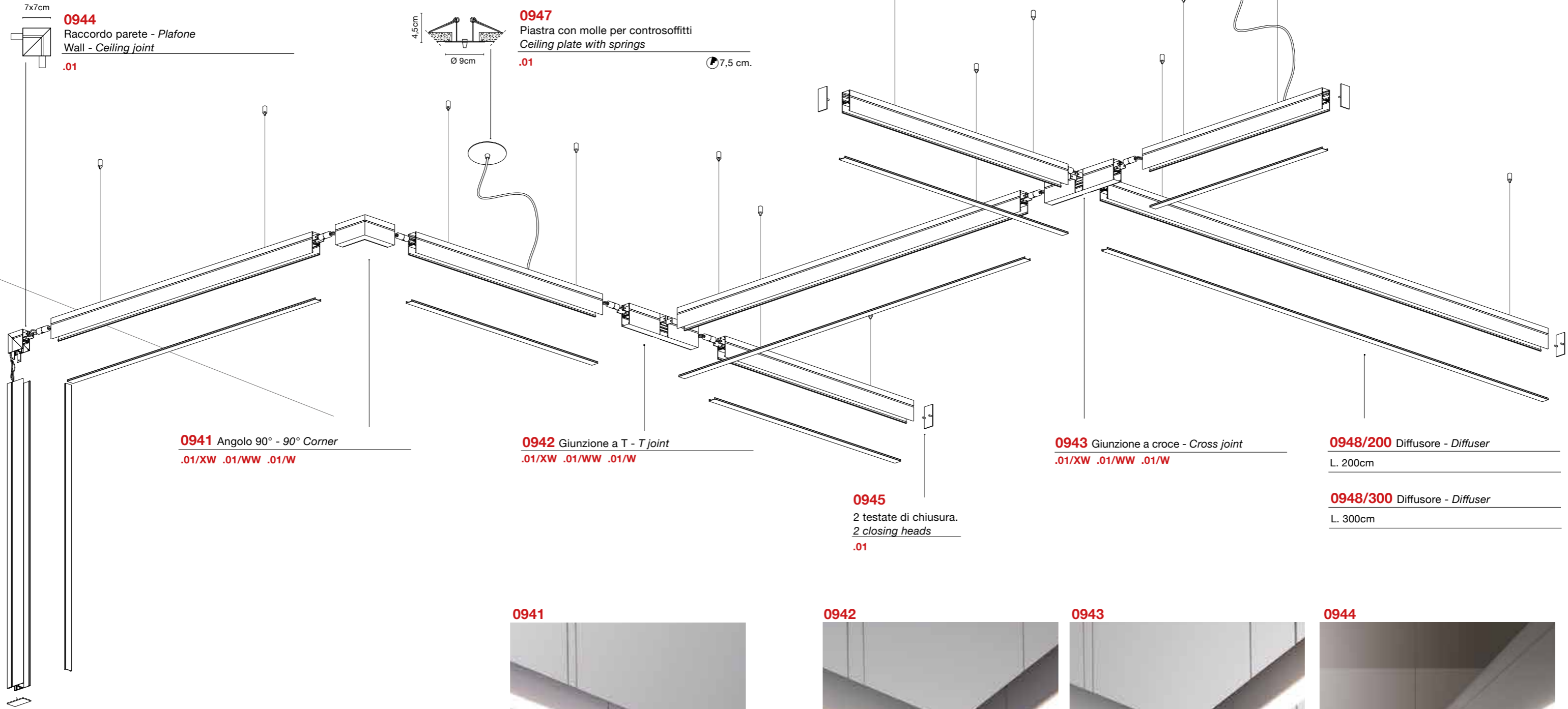

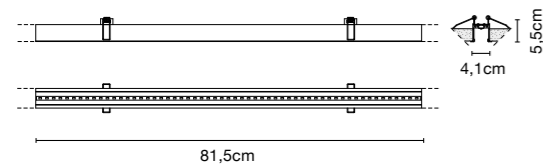

6660 1,1 kg

/XW Led 12W 1424lm 2700K

/WW Led 12W 1520lm 3000K

/W Led 12W 1600lm 4000K

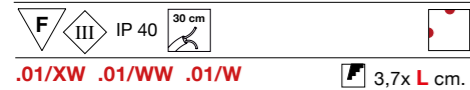

CUSTOM SIZE - Tabella lunghezze disponibili a richiesta. Table of available lengths on request.

cm.	watt	2700K (XW)	lm	3000K (WW)	lm	4000K (W)	lm
11,5	1,5W	A6660.01/10/XW	178	A6660.01/10/WW	190	A6660.01/10/W	200
21,5	3W	A6660.01/20/XW	356	A6660.01/20/WW	380	A6660.01/20/W	400
31,5	4,5W	A6660.01/30/XW	534	A6660.01/30/WW	570	A6660.01/30/W	600
41,5	6W	A6660.01/40/XW	712	A6660.01/40/WW	760	A6660.01/40/W	800
51,5	7,5W	A6660.01/50/XW	890	A6660.01/50/WW	950	A6660.01/50/W	1000
61,5	9W	A6660.01/60/XW	1068	A6660.01/60/WW	1140	A6660.01/60/W	1200
71,5	10,5W	A6660.01/70/XW	1246	A6660.01/70/WW	1330	A6660.01/70/W	1400
★ 81,5	12W	6660.01/XW	1424	6660.01/WW	1520	6660.01/W	1600
91,5	13,5W	A6660.01/90/XW	1602	A6660.01/90/WW	1710	A6660.01/90/W	1800
101,5	15W	A6660.01/100/XW	1780	A6660.01/100/WW	1900	A6660.01/100/W	2000
111,5	16,5W	A6660.01/110/XW	1958	A6660.01/110/WW	2090	A6660.01/110/W	2200
121,5	18W	A6660.01/120/XW	2136	A6660.01/120/WW	2280	A6660.01/120/W	2400
131,5	19,5W	A6660.01/130/XW	2314	A6660.01/130/WW	2470	A6660.01/130/W	2600
141,5	21W	A6660.01/140/XW	2492	A6660.01/140/WW	2660	A6660.01/140/W	2800
151,5	22,5W	A6660.01/150/XW	2670	A6660.01/150/WW	2850	A6660.01/150/W	3000
161,5	24W	A6660.01/160/XW	2848	A6660.01/160/WW	3040	A6660.01/160/W	3200
171,5	25,5W	A6660.01/170/XW	3026	A6660.01/170/WW	3230	A6660.01/170/W	3400
181,5	27W	A6660.01/180/XW	3204	A6660.01/180/WW	3420	A6660.01/180/W	3600
191,5	28,5W	A6660.01/190/XW	3382	A6660.01/190/WW	3618	A6660.01/190/W	3800
201,5	30W	A6660.01/200/XW	3560	A6660.01/200/WW	3800	A6660.01/200/W	4000
211,5	31,5W	A6660.01/210/XW	3738	A6660.01/210/WW	3990	A6660.01/210/W	4200
221,5	33W	A6660.01/220/XW	3916	A6660.01/220/WW	4180	A6660.01/220/W	4400
231,5	34,5W	A6660.01/230/XW	4094	A6660.01/230/WW	4370	A6660.01/230/W	4600
241,5	36W	A6660.01/240/XW	4272	A6660.01/240/WW	4560	A6660.01/240/W	4800
251,5	37,5W	A6660.01/250/XW	4450	A6660.01/250/WW	4750	A6660.01/250/W	5000
261,5	39W	A6660.01/260/XW	4628	A6660.01/260/WW	4940	A6660.01/260/W	5200
271,5	40,5W	A6660.01/270/XW	4806	A6660.01/270/WW	5130	A6660.01/270/W	5400
281,5	42W	A6660.01/280/XW	4984	A6660.01/280/WW	5320	A6660.01/280/W	5600
291,5	43,5W	A6660.01/290/XW	5162	A6660.01/290/WW	5510	A6660.01/290/W	5800
301,5	45W	A6660.01/300/XW	5340	A6660.01/300/WW	5700	A6660.01/300/W	6000

★ Articolo standard a catalogo - Standard catalogue item

FORO INCASSO - CUTOUT

La lunghezza totale del foro d'incasso si ottiene aggiungendo 0,6 cm alla somma delle lunghezze dei singoli pezzi
Total length of the cutout is obtained by adding 0,6 cm to the sum of each component length.



Giunzione a croce - Cross joint



0956 0,35 kg

/XW Led 4,5W 534lm 2700K

/WW Led 4,5W 570lm 3000K

/W Led 4,5W 600lm 4000K



.01/XW .01/WW .01/W



Angolo 90° - 90° Corner

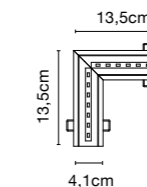

0957 0,4 kg

/XW Led 3W 356lm 2700K

/WW Led 3W 380lm 3000K

/W Led 3W 400lm 4000K

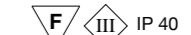

.01/XW .01/WW .01/W



Giunzione a T - T joint

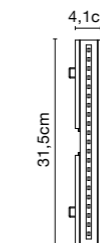

0958 0,35kg

/XW Led 4,5W 534lm 2700K

/WW Led 4,5W 570lm 3000K

/W Led 4,5W 600lm 4000K

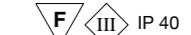

.01/XW .01/WW .01/W



Diffusore - Diffuser

0948/100

L. 100cm

0948/200

L. 200cm

0948/300

L. 300cm

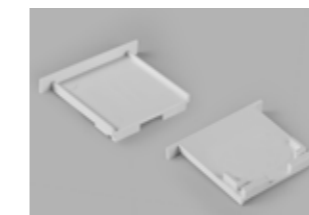

2 testate di chiusura.
2 closing heads.

0939

.01

0939
2 testate di chiusura.
2 closing heads
.01

0956
Giunzione a croce - Cross joint
.01/XW .01/WW .01/W

0957
Angolo 90° - 90° Corner
.01/XW .01/WW .01/W

0958
Giunzione a T - T joint
.01/XW .01/WW .01/W

24V DC

0948/200
Diffusore - Diffuser
L. 200cm

0948/300
Diffusore - Diffuser
L. 300cm

0956

0957

0958

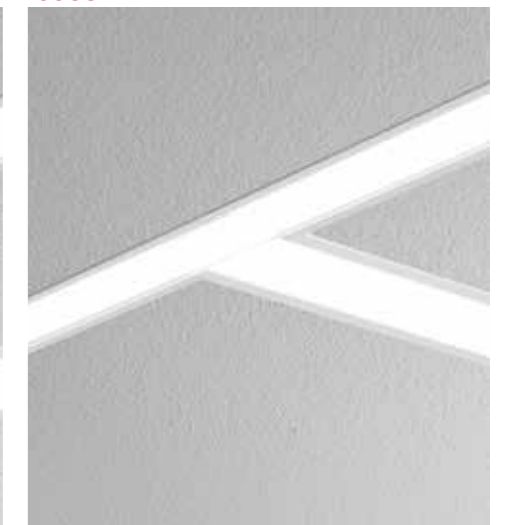
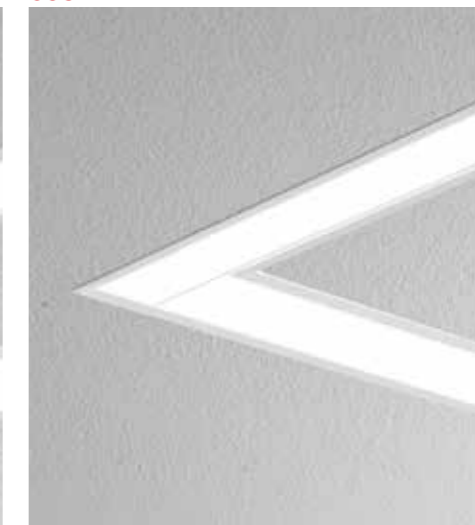

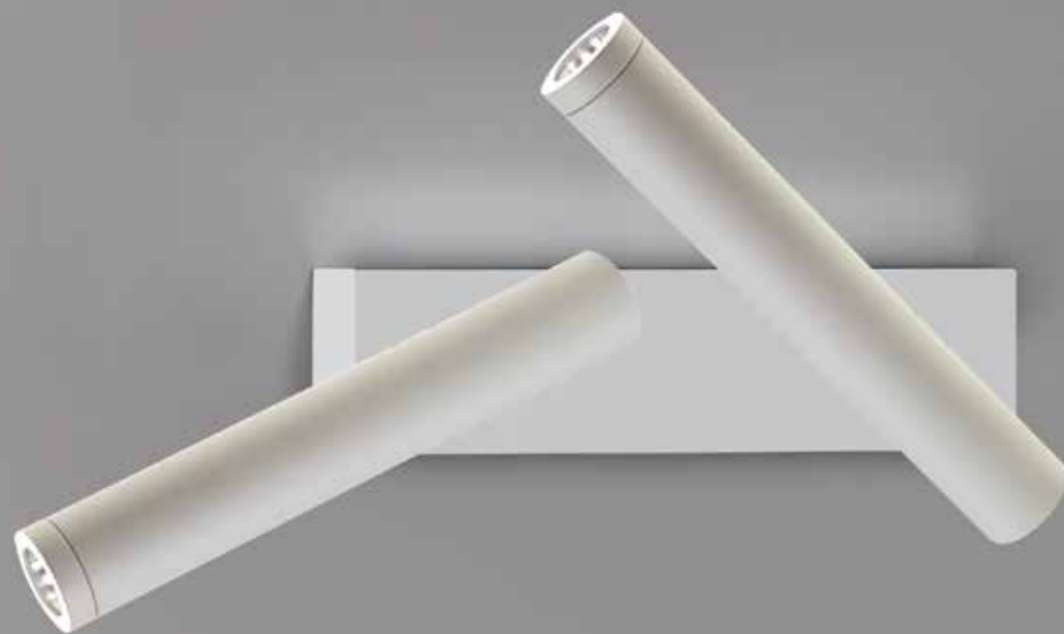

Newton Uno/Due

Proiettori orientabili da Soffitto/Parete.
Corpo in metallo verniciato bianco,
nero o cromato.

Disponibile anche in versione GU10 con diverse finiture

- Dissipazione passiva
- Inclinazione di 90° su piano orizzontale
- Rotazione di 350° su asse verticale.
- Diverse ottiche disponibili.
- Accessori decorativi.
- Accessori ottici.
- Temperature di colore disponibili: 2700,3000,4000K.

*Ceiling/Wall adjustable spotlights.
Metal frame available in white or black
painted finish or chromed.
Also available with GU10 bulb socket
and in more finishes.*

- *Passive heatsink*
- *90° regulation on horizontal plan*
- *350° rotation on vertical axis*
- *Different beam and optics solutions*
- *Decorative accessories*
- *Optic accessories*
- *Available light tones: 2700, 3000, 4000K*

Newton Uno

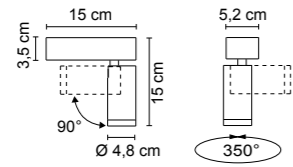
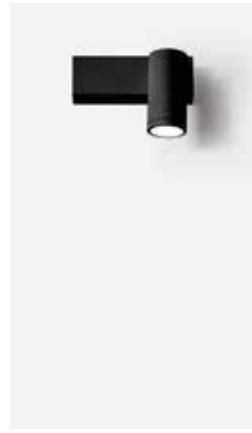

4562 0,60 kg

.01	Bianco - White
.02	Nero - Black
.31	Cromato - Chromed

LED cod.	OPTIC degree/OPTION	Im	LED color
/W	/24 /38 /58	LED 8,9W 500mA	1353lm 4000K
/W/ST	Vetro satinato - Satin glass	LED 8,9W 500mA 38°	1353lm 4000K
/WW	/24 /38 /58	LED 8,9W 500mA	1303lm 3000K
/WW/ST	Vetro satinato - Satin glass	LED 8,9W 500mA 38°	1303lm 3000K
/XW	/24 /38 /58	LED 8,9W 500mA	1244lm 2700K
/XW/ST	Vetro satinato - Satin glass	LED 8,9W 500mA 38°	1244lm 2700K

F

Newton Slim Uno

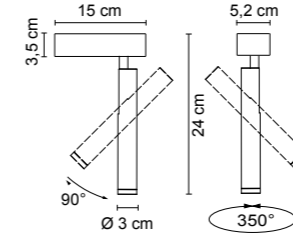

4610 0,50 kg

.01	Bianco - White
.02	Nero - Black
.31	Cromato - Chromed

LED cod.	OPTIC degree/OPTION	Im	LED color
/W	/35 /48 /63	LED 8,9W 17,8V 500mA	1353lm 4000K
/W/ST	Vetro satinato - Satin glass	LED 8,9W 17,8V 500mA 35°	1353lm 4000K
/WW	/35 /48 /63	LED 8,9W 17,8V 500mA	1303lm 3000K
/WW/ST	Vetro satinato - Satin glass	LED 8,9W 17,8V 500mA 35°	1303lm 3000K
/XW	/35 /48 /63	LED 8,9W 17,8V 500mA	1244lm 2700K
/XW/ST	Vetro satinato - Satin glass	LED 8,9W 17,8V 500mA 35°	1244lm 2700K

F

Newton Due

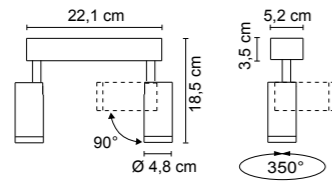

4612 1,25 kg

.01	Bianco - White
.02	Nero - Black
.31	Cromato - Chromed

LED cod.	OPTIC degree/OPTION	Im	LED color
/W	/24 /38 /58	LED 2x8,9W 500mA	2706lm 4000K
/W/ST	Vetro satinato - Satin glass	LED 2x8,9W 500mA 38°	2706lm 4000K
/WW	/24 /38 /58	LED 2x8,9W 500mA	2606lm 3000K
/WW/ST	Vetro satinato - Satin glass	LED 2x8,9W 500mA 38°	2606lm 3000K
/XW	/24 /38 /58	LED 2x8,9W 500mA	2488lm 2700K
/XW/ST	Vetro satinato - Satin glass	LED 2x8,9W 500mA 38°	2488lm 2700K

F

Newton Slim Due

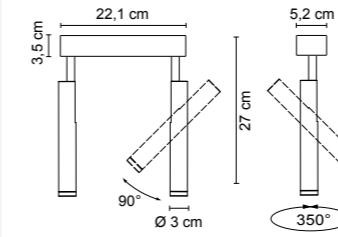

4613 1,10 kg

.01	Bianco - White
.02	Nero - Black
.31	Cromato - Chromed

LED cod.	OPTIC degree/OPTION	Im	LED color
/W	/35 /48 /63	LED 2x8,9W 17,8V 500mA	2706lm 4000K
/W/ST	Vetro satinato - Satin glass	LED 2x8,9W 17,8V 500mA 35°	2076lm 4000K
/WW	/35 /48 /63	LED 2x8,9W 17,8V 500mA	2606lm 3000K
/WW/ST	Vetro satinato - Satin glass	LED 2x8,9W 17,8V 500mA 35°	2606lm 3000K
/XW	/35 /48 /63	LED 2x8,9W 17,8V 500mA	2488lm 2700K
/XW/ST	Vetro satinato - Satin glass	LED 2x8,9W 17,8V 500mA 35°	2488lm 2700K

F

Ottiche Disponibili - Available Optics

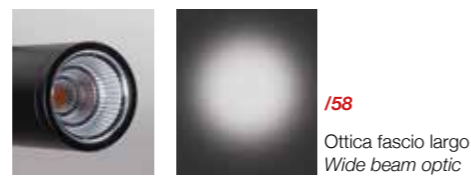

Accessori - Accessories

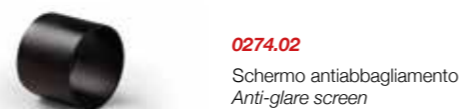

Ottiche Disponibili - Available Optics



Accessori - Accessories



Newton Flat Uno

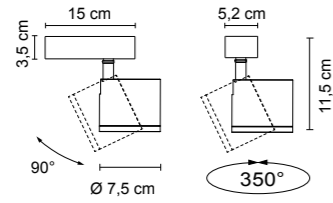

4611 0,55 kg

.01	Bianco - <i>White</i>
.02	Nero - <i>Black</i>
.31	Cromato - <i>Chromed</i>

LED cod.	OPTIC degree/OPTION	Im	LED color
/W	/13 /40 LED 8,9W 17,8V 500mA	1353lm	4000K
/W/ST	Vetro satinato - <i>Satin glass</i> LED 8,9W 17,8V 500mA 40°	1353lm	4000K
/WW	/13 /40 LED 8,9W 17,8V 500mA	1303lm	3000K
/WW/ST	Vetro satinato - <i>Satin glass</i> LED 8,9W 17,8V 500mA 40°	1303lm	3000K
/XW	/13 /40 LED 8,9W 17,8V 500mA	1244lm	2700K
/XW/ST	Vetro satinato - <i>Satin glass</i> LED 8,9W 17,8V 500mA 40°	1244lm	2700K



Newton Flat Due

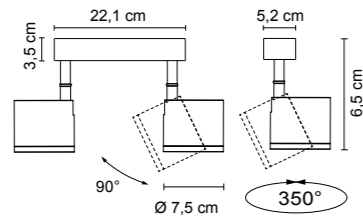

4614 1,20 kg

.01	Bianco - <i>White</i>
.02	Nero - <i>Black</i>
.31	Cromato - <i>Chromed</i>

LED cod.	OPTIC degree/OPTION	Im	LED color
/W	/13 /40 LED 2x8,9W 17,8V 500mA	2706lm	4000K
/W/ST	Vetro satinato - <i>Satin glass</i> LED 2x8,9W 17,8V 500mA 40°	2706lm	4000K
/WW	/13 /40 LED 2x8,9W 17,8V 500mA	2606lm	3000K
/WW/ST	Vetro satinato - <i>Satin glass</i> LED 2x8,9W 17,8V 500mA 40°	2606lm	3000K
/XW	/13 /40 LED 2x8,9W 17,8V 500mA	2488lm	2700K
/XW/ST	Vetro satinato - <i>Satin glass</i> LED 2x8,9W 17,8V 500mA 40°	2488lm	2700K



Ottiche Disponibili - Available Optics



/13
Ottica a fascio stretto per luce d'accento
Narrow beam optic for accent lighting



/ST
Ottica fascio diffuso per illuminazione generale
Diffused light optic for general lighting



/40
Ottica fascio largo
Wide beam optic

Accessori - Accessories



0264.01
Parabola decorativa
Decorative parabolic reflector



0264.02
Parabola decorativa
Decorative parabolic reflector

Newton Easy GU10

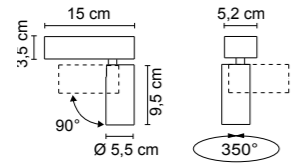

4618	0,50 kg
.01	Bianco - <i>White</i>
.02	Nero - <i>Black</i>
7W GU10 LED (art.0094/16)	
F	

Newton Easy Spot GU10

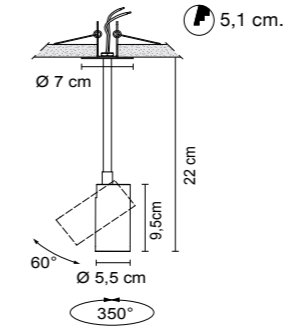

6481	0,40 kg
.01	Bianco - <i>White</i>
.02	Nero - <i>Black</i>
.02.25	Nero / Corpo dorato satinato - <i>Black / Satin gold body</i>
.02.32	Nero / Corpo Nickel satinato - <i>Black / Nickel matt body</i>
7W GU10 LED (art.0094/16)	
F	

Newton Easy GU10 Due

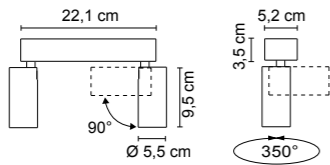
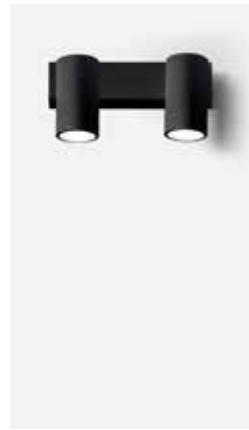

4619	0,80 kg
.01	Bianco - <i>White</i>
.02	Nero - <i>Black</i>
7W GU10 LED (art.0094/16)	
F	



02/25 Dorato Satinato - *Satin Gold*



02/32 Nickel Satinato - *Nickel Matt*



02 Nero - *Black*



01 Bianco - *White*

Finiture - Finishes



.01 Bianco
White



.02 Nero
Black



.25 Dorato Satinato
Satin Gold



.31 Cromato
Chromed



.32 Nickel Satinato
Nickel Mat

Marchi - Mark



Apparecchio in Classe II, munito di isolamento doppio o rinforzato.

Fixture on Class II, with double or reinforced insulation.



Apparecchio a bassissima tensione con trasformatore remoto.

SELV fixture with remote transformer.



Apparecchio adatto ad essere installato su superfici normalmente infiammabili.

Fixture ready for installation on normally inflammable surfaces.

Simboli - Signs



Foro incasso.

Cut out.



Alimentatore incluso
Alimentatore non incluso

*Converter included
Converter not included*



Lunghezza cavo

Cable length

Codice colore luce Light Color Codes

/XW Extra White Led 2700K

/WW Warm White Led 3000K

/W Natural White Led 4000K

/CW Cold White Led 5000K

Codice versioni Option Codes

/EM Emergenza
Emergency

/DIM Dimmerabile
Dimming

/DALI Dimmerabile
Dimming

/ST Con diffusore satinato
Satin diffuser

CRI >90: a richiesta
upon request

I valori di lumen (lm) riportati si riferiscono al flusso luminoso nominale della sorgente LED

The values of lumens (lm) indicated referring to the nominal luminous flux of the LED source



I nostri prodotti sono costruiti in conformità alle norme europee CEI-EN 60598 e, come tali, recano la marcatura CE.

Our fittings are manufactured in conformity with the european standard CEI-EN 60598 and, consequently, get the mark CE.

LA NOSTRA MISSIONE: MADE IN ITALY

Da sempre **l'Italia è la culla della creatività.**

Know-how e stile italiano sono identificati e apprezzati ovunque, tanto che il **marchio Made in Italy** ha sempre costituito un **valore aggiunto** ricercato in tutto il mondo.

Il prodotto italiano può essere immediatamente riconosciuto grazie ai **dettagli, all'attenzione** e ai **valori estetici** che sono da sempre il nostro biglietto da visita.

Sulla scia di questa grande tradizione, **dal 1978 EGOLUCE crea prodotti 100% Made in Italy**, collaborando principalmente con aziende e artigiani italiani: per offrire ai propri clienti **un prodotto di design con i più alti standard tecnologici.**

La **scelta diligente e attenta dei componenti e dei materiali** di migliore qualità e la lavorazione guidata da criteri di qualità totale, ci consente di produrre e offrire ai nostri clienti una vasta gamma di corpi illuminanti per diverse applicazioni.

Le soluzioni di progettazione illuminotecnica qualificate identificano Egoluce come uno dei più importanti produttori mondiali di illuminazione. **Prodotti 100% Made in Italy.**

OUR MISSION: MADE IN ITALY

Since ever **Italy is the cradle of creativity.**

An aware production know how and style are identified and commended throughout the world, so much so that the **Made in Italy mark** has always constituted sought-after an **added value.**

An Italian product can immediately be recognized: **details, attention** and the **aesthetic values** are their business card.

In the wake of this great tradition, **since 1978 EGOLUCE has been creating 100% Made in Italy products**, mostly collaborating with Italian companies and craftsmen: in order to offer its clients a **design product with highest technology standard.**

The diligent and **careful selection of best quality components and materials** and the

processing guided by criteria such as total quality, enable us to produce and offer to our clients a vast range of light fixtures for several applications.

Qualified Lighting design solutions identify Egoluce as one of the most important player in the worldwide lighting producer.

Products 100% Made in Italy.



MADE IN ITALY

EGOLUCE s.r.l. Via I. Newton, 12 - 20016 Pero - Milano - Italy - Tel. +39 02339586.1 - Italia fax +39 023535112
Int. fax +39 0233911087 E-mail: info@egoluce.com - Int. E-mail: infoworld@egoluce.com - www.egoluce.com