

IL FANALE[®]

IL FANALE®

2017





NEW YORK TIMES SQUARE
Rockefeller 5TH AVENUE
Greenwich Vill LEXINGTON
CENTRAL PARK Tribec
7TH AVENUE Broadway
BROOKLYN BRIDGE 34
PARK AVE ROOSEVELT BRYANT PAR
Columbus Circle
Union Square SOH

IL FANALE®

DAL 1979

LA STORIA DE IL FANALE RISALE AL 1979, QUANDO FAUSTO DALLA TORRE E SUA MOGLIE LUISA MARTIN, DECIDONO DI INTRAPRENDERE UNO STRAORDINARIO PERCORSO FATTO DI PASSIONE E DURO LAVORO. PARTENDO DALLA LORO DECENNALE ESPERIENZA NELLA LAVORAZIONE DEI METALLI TRADIZIONALI, FONDANO L'AZIENDA CON L'INTENZIONE E LA VOLONTÀ DI PRODURRE LAMPADE ORIGINALI E UNICHE DI ALTISSIMA QUALITÀ.

DEDIZIONE, DETERMINAZIONE E IMPEGNO SONO LE QUALITÀ CHE RENDONO IL FANALE QUELLO CHE È OGGI: UN'AZIENDA ARTIGIANA DI SUCCESSO NEL SETTORE DELL'ILLUMINAZIONE, CONOSCIUTA IN ITALIA E ALL'ESTERO.

THE STORY OF IL FANALE DATES BACK TO 1979 WHEN FAUSTO DALLA TORRE AND HIS WIFE LUISA MARTIN, DECIDED TO EMBARK ON AN EXTRAORDINARY JOURNEY OF PASSION AND HARD WORK. STARTING FROM THEIR DECENNIAL EXPERIENCE IN WORKING WITH TRADITIONAL METALS, THEY FOUND THE COMPANY WITH THE INTENTION AND THE WILL TO PRODUCE UNIQUE AND ORIGINAL LAMPS OF THE HIGHEST QUALITY.

DEDICATION, DETERMINATION AND COMMITMENT ARE THE QUALITIES THAT MAKE IL FANALE WHAT IT IS TODAY: A SUCCESSFUL HANDICRAFT COMPANY WORKING IN THE LIGHTING INDUSTRY, KNOWN IN ITALY AND ABROAD.

INDEX

INDOOR	MOLECOLA	014 - 029
	ÉTOILE	030 - 043
	ASTRO	044 - 051
	ALCHIMIA	052 - 065
	LOFT	066 - 079
	REPORTER	080 - 089
	OFFICINA	090 - 099
	KHONUS	100 - 107
	GIRASOLI	108 - 119
	LONDON	120 - 137
	POGGIO	150 - 157
	CANTINA	158 - 165
	CASCINA	166 - 175
	COUNTRY	176 - 189
	MINI	190 - 197
	FIORI DI PIZZO	198 - 207
	ANITA	208 - 217
	TABIÀ	218 - 227
RILEGATO	409 - 429	
INDOOR / OUTDOOR	GALILEO	138 - 149
	CONTRADA	228 - 235
	BARCHESSA	236 - 247
	DROP	248 - 263
OUTDOOR	LANTERNE	264 - 277
	QUADRO	278 - 285
	DECORI	286 - 295
	BORGO	296 - 305
	CALMAGGIORE	306 - 313
	PATIO	314 - 321
	GRANAIO	322 - 329
	FIORDO	330 - 337
	VENEZIA	338 - 351
	LOGGIA	352 - 359
	GARDEN	360 - 367
	PORTO	368 - 373
	MARINA	374 - 383
	PONTE	384 - 391
SISTEMI / SYSTEMS	SISTEMA CANALINE	392 - 407
	COMPANY	431 - 433
	MANUFACTURING	435 - 438
	PROJECTS	439 - 469
	F.A.Q	471 - 473

ALPHABETICAL INDEX

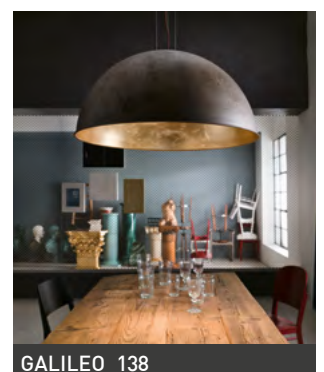
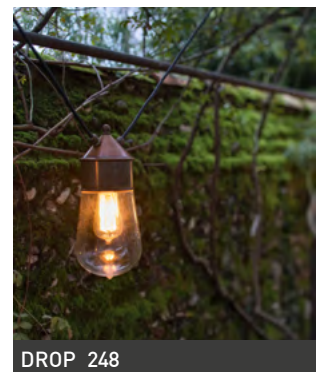
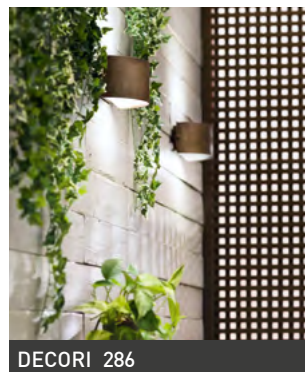
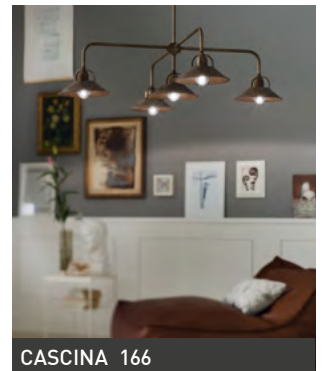
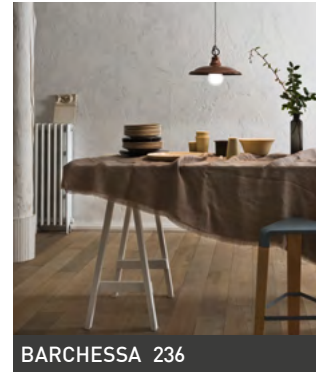
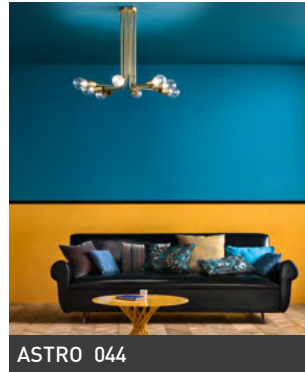
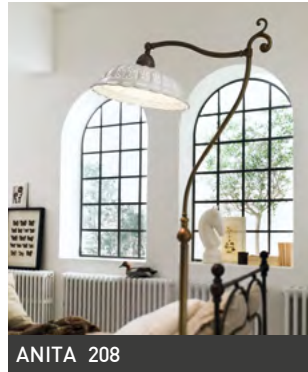
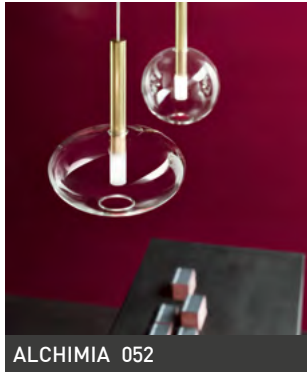



GARDEN 360



GIRASOLI 108



GRANAIO 322

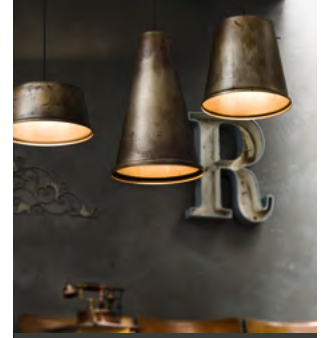

KHONUS 100



LANTERNE 264



LOFT 066



LOGGIA 352



LONDON 120



MARINA 374



MINI 190



MOLECOLA 014



OFFICINA 090



PATIO 314



POGGIO 150



PONTE 384

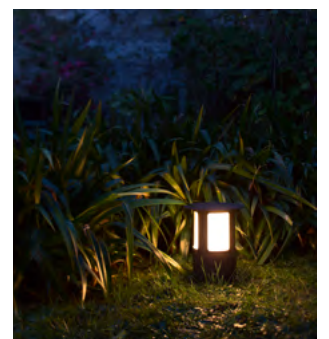

PORTO 368

ALPHABETICAL INDEX



COMPANY INDEX



COMPANY 431



MANUFACTURING 435



PROJECTS 439

MOLECOLA

design
FABRIZIO FAVA





DISPONIBILE NELLE VERSIONI
IN OTTONE NATURALE O OTTONE
ANTICATO CON SFERE DI VETRO
TRASPARENTE E SABBIAIO, LA
COLLEZIONE DI LAMPADE DA
INTERNO MOLECOLA SI COMPONE
DI SOSPENSIONI, PIANTANA,
PLAFONIERE, APPLIQUE E LAMPADA
DA TAVOLO.

THE MOLECOLA COLLECTION
OF INDOOR LAMPS COMPRISES
SUSPENSION LAMPS, A FLOOR LAMP,
CEILING LAMPS, A WALL LAMP AND
A TABLE LAMP. THEY ARE AVAILABLE
IN NATURAL OR ANTIQUE-EFFECT
BRASS WITH TRANSPARENT AND
FROSTED SPHERES.

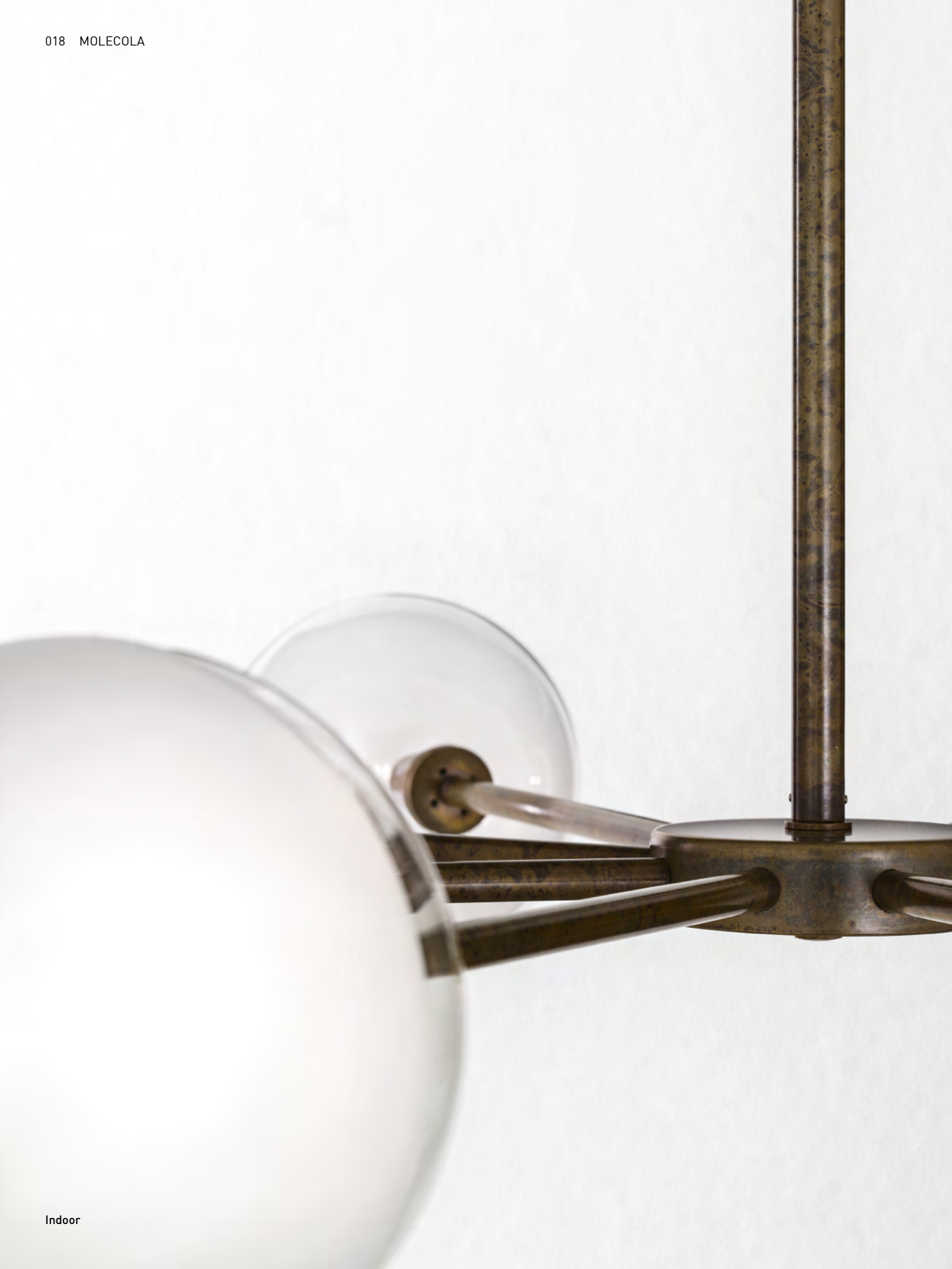













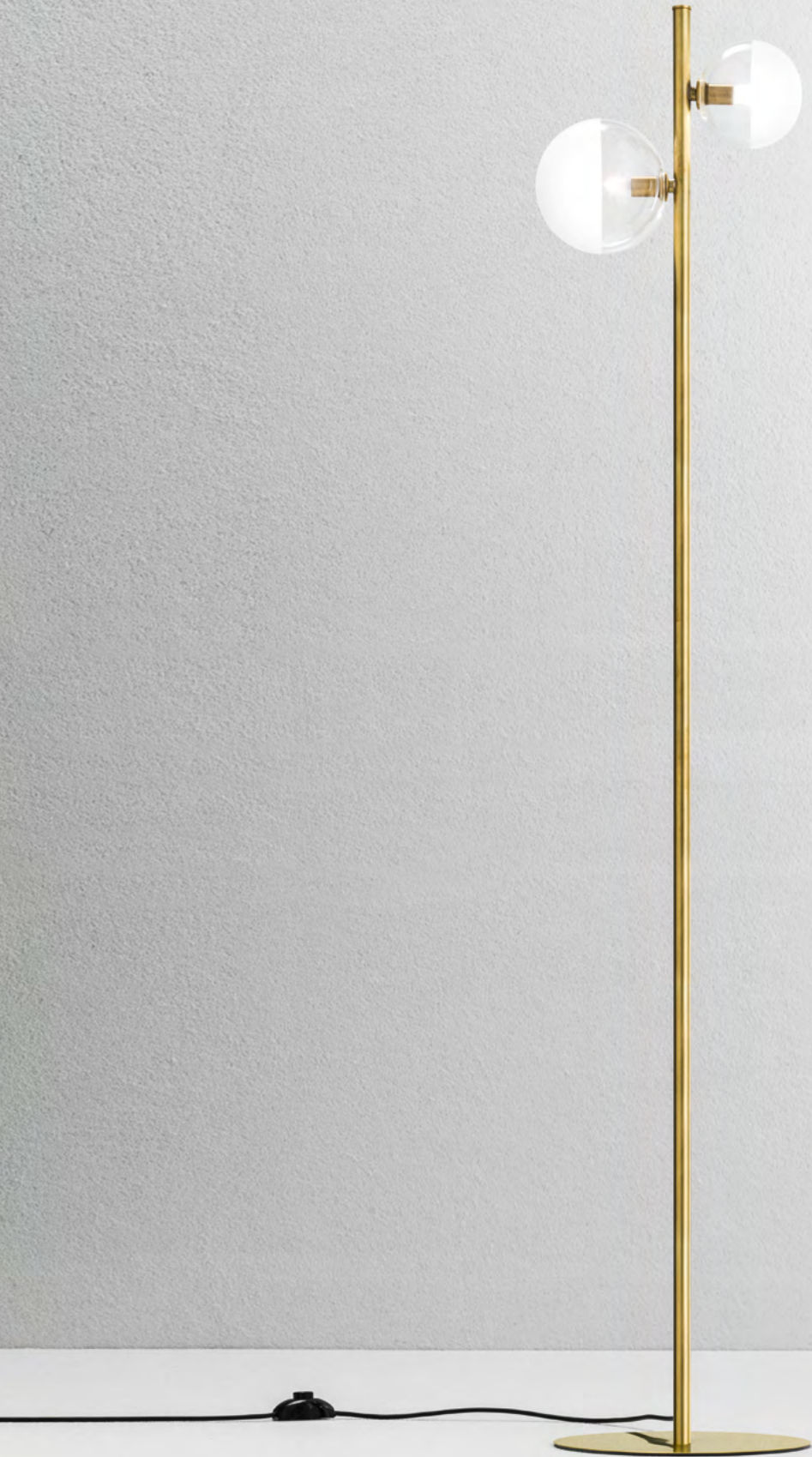



lampade / lamps

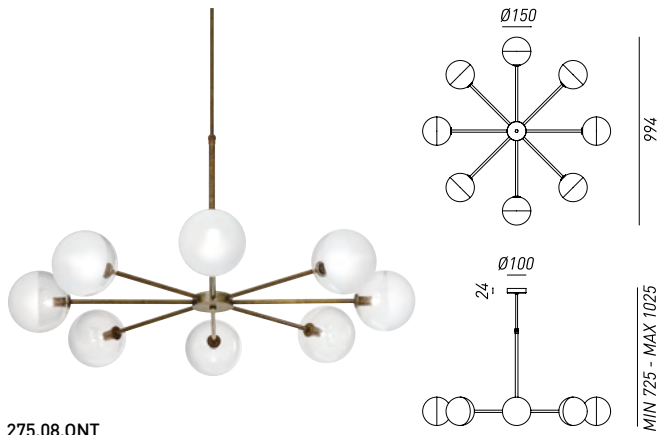

275.08.ONT
275.08.OOT
8x Max 25W G9

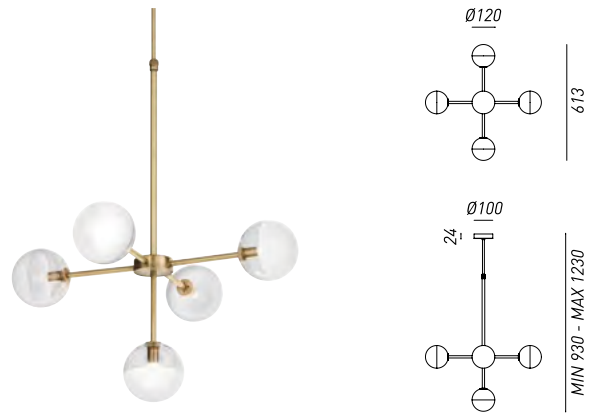

275.09.ONT
275.09.OOT
5x Max 25W G9

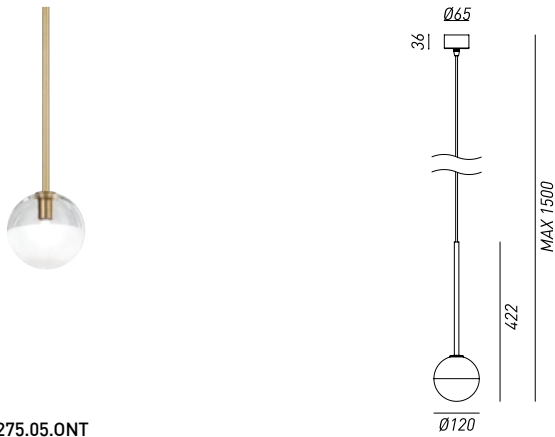

275.05.ONT
275.05.OOT
1x Max 25W G9

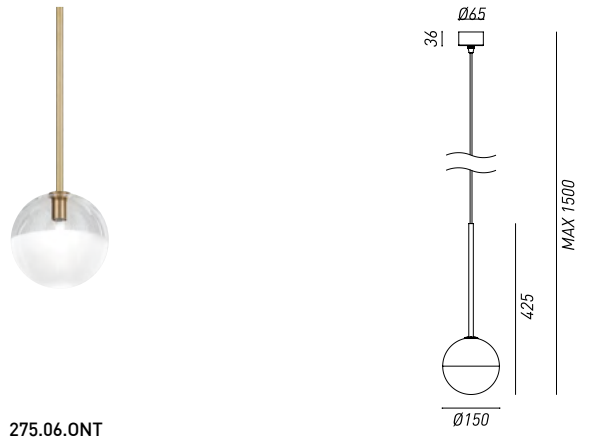

275.06.ONT
275.06.OOT
1x Max 25W G9



275.01.ONT
275.01.OOT
1x Max 25W G9



275.02.ONT
275.02.OOT
1x Max 25W G9

lampade / lamps

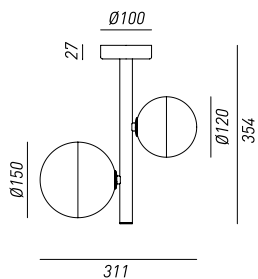

275.04.ONT
275.04.00T
2x Max 25W G9

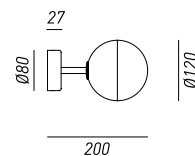

275.03.ONT
275.03.00T
1x Max 25W G9

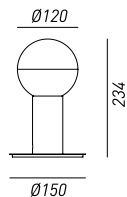

275.10.ONT
275.10.00T
1x Max 25W G9

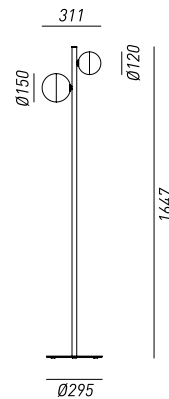

275.11.ONT
275.11.00T
2x Max 25W G9

finiture montatura / frame finishes



OTTONE
BRASS



OTTONE NATURALE
NATURAL BRASS

vetro / glass



VETRO TRASPARENTE / BIANCO
TRANSPARENT / WHITE GLASS

ÉTOILE

design
MIRTA LANDO





ELEGANTE E RAFFINATA COME LA PRIMA BALLERINA DI UN CORPO DI BALLO: COSÌ SI PRESENTA LA COLLEZIONE DI LAMPADE DA INTERNO ÉTOILE. LA COLLEZIONE, DISPONIBILE CON MONTATURA IN OTTONE NATURALE O OTTONE ANTICATO E VETRO BOROSILICATO, È COMPOSTA DA SOSPENSIONI, PIANTANA, LAMPADA DA TAVOLO, PLAFONIERA E APPLIQUE.

THE ÉTOILE COLLECTION OF INDOOR LAMPS IS AS ELEGANT AND SOPHISTICATED AS THE PRINCIPAL DANCER OF A BALLET COMPANY. AVAILABLE WITH STRUCTURE IN NATURAL OR ANTIQUE-EFFECT BRASS AND BOROSILICATE WHITE GLASS, THE COLLECTION COMPRISES SUSPENSION LAMPS, A FLOOR LAMP, A TABLE LAMP, A CEILING LAMP AND WALL LAMPS.

















lampade / lamps

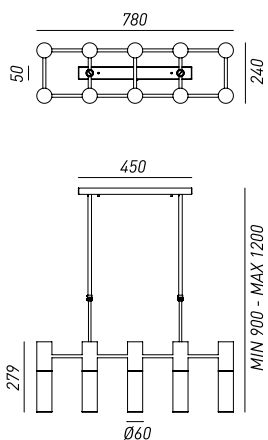

274.10.ONB
274.10.OOB
10x Max 25W G9

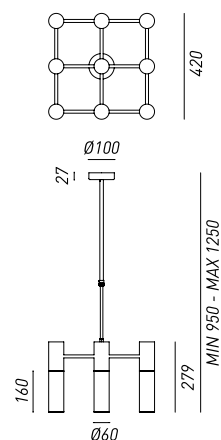

274.09.ONB
274.09.OOB
9x Max 25W G9

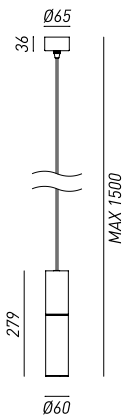

274.07.ONB
274.07.OOB
1x Max 25W G9



274.01.ONB
274.01.OOB
1x Max 25W G9

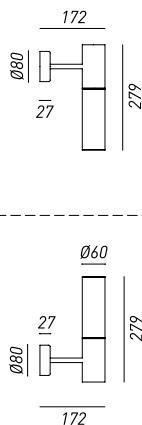

274.03.ONB
274.03.OOB
1x Max 25W G9

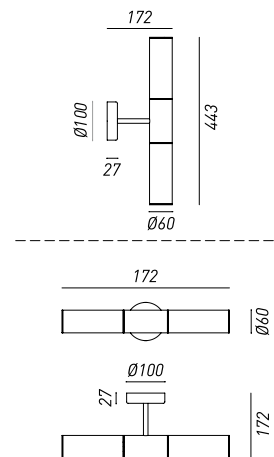
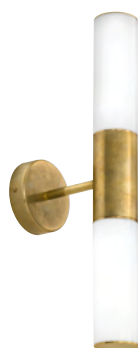

274.04.ONB
274.04.OOB
2x Max 25W G9

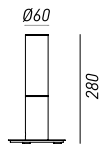

274.05.ONB
274.05.OOB
1x Max 25W G9 

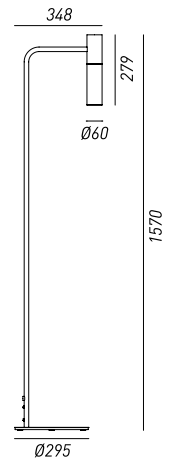

274.06.ONB
274.06.OOB
1x Max 25W G9 

finiture montatura / frame finishes



OTTONE
BRASS



OTTONE NATURALE
NATURAL BRASS

vetro / glass



VETRO BIANCO
WHITE GLASS

ASTRO



LINEE PULITE ED ESSENZIALI DANNO
RISALTO ALLA PUREZZA DELLA
MATERIA E CARATTERIZZANO QUESTE
LAMPADE DA INTERNO REALIZZATE
IN OTTONE NATURALE E OTTONE
ANTICATO.

CLEAN ESSENTIAL LINES ENHANCE
THE PURITY OF THE MATERIAL OF
THESE INDOOR LAMPS MADE OF
NATURAL AND ANTIQUE BRASS.







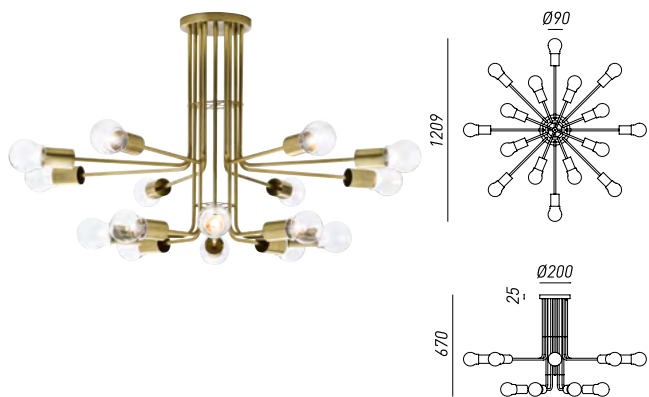

Lampade / lamps

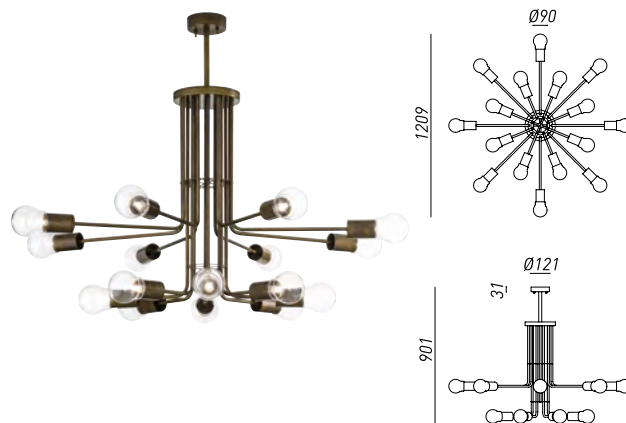

276.10.ONT
276.10.00T
16x Max 25W G9 



276.13.ONT
276.13.00T
16x Max 25W G9 

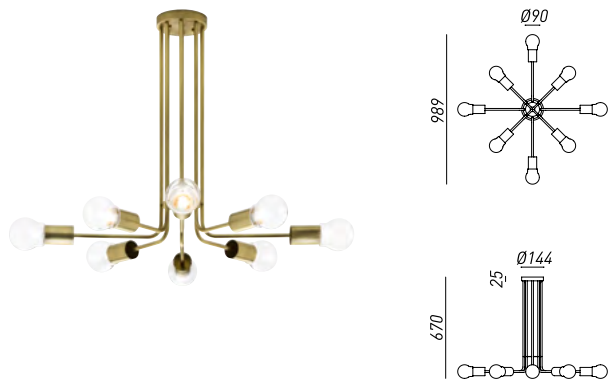

276.09.ONT
276.09.00T
8x Max 25W G9 

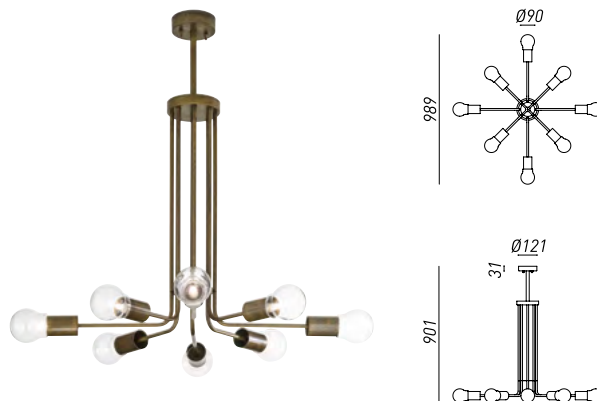

276.12.ONT
276.12.00T
8x Max 25W G9 



276.11.ONT
276.11.00T
6x Max 25W G9 



276.14.ONT
276.14.00T
6x Max 25W G9 

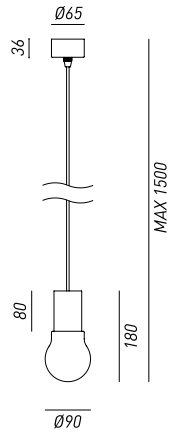

276.05.ONT
276.05.OOT
1x Max 25W G9

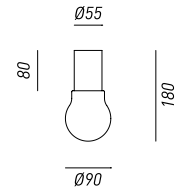

276.01.ONT
276.01.OOT
1x Max 25W G9

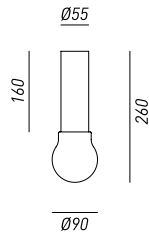

276.02.ONT
276.02.OOT
1x Max 25W G9

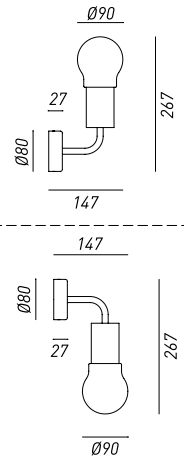

276.03.ONT
276.03.OOT
1x Max 25W G9

finiture montatura / frame finishes



OTTONE
BRASS



OTTONE NATURALE
NATURAL BRASS

vetro / glass



VETRO TRASPARENTE
TRANSPARENT GLASS

ALCHIMIA

design
BROGLIATOTRAVERSO





UN GIOCO DI PROPORZIONI ED ACCOSTAMENTI, DI DIMENSIONI, DI MATERIALI E DI FORME CHE DANNO VITA A LAMPADE IN OTTONE NATURALE O ANTICATO E VETRO TRASPARENTE, DELICATE E RAFFINATE.

UNA FAMIGLIA DI LAMPADE DA COMPORRE PER RENDERE UNICO UN AMBIENTE, GENERANDO UNO SPAZIO NELLO SPAZIO: IL RISULTATO FINALE È APPUNTO UNA QUESTIONE DI ALCHIMIA.

AN INTERPLAY OF PROPORTIONS AND COMBINATIONS, OF DIMENSIONS, MATERIALS AND SHAPES GIVES LIFE TO DELICATE REFINED LAMPS MADE OF NATURAL OR ANTIQUE-EFFECT BRASS AND TRANSPARENT GLASS.

A COLLECTION OF LAMPS TO PUT TOGETHER TO MAKE AN ENVIRONMENT UNIQUE, CREATING A SPACE IN SPACE: THE END RESULT IS PRECISELY A MATTER OF ALCHEMY.



**SISTEMA COMPOSTO DA / SYSTEM MADE OF:**

Codici / Codes: 1 X 277.12.ON
1 X 277.13.ON
1 X 277.14.ON
1 X 277.15.ON
1 X 277.16.ON
6 X 300.42.ON
1 X 300.41.ON
1 X 270.38.AA
1 X 270.37.10











lampade / lamps

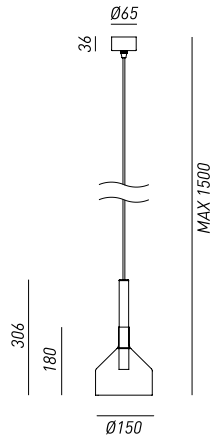

277.02.0NT
277.02.00T
1x Max 25W G9

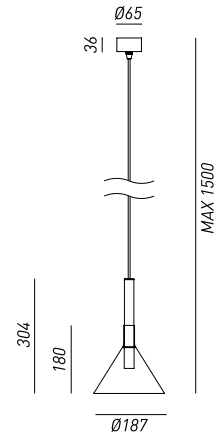

277.03.0NT
277.03.00T
1x Max 25W G9

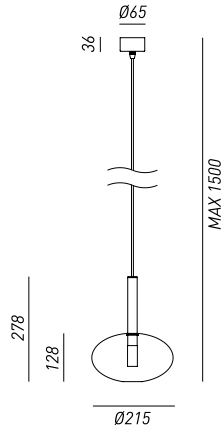

277.04.0NT
277.04.00T
1x Max 25W G9

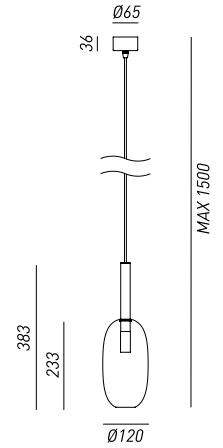

277.05.0NT
277.05.00T
1x Max 25W G9

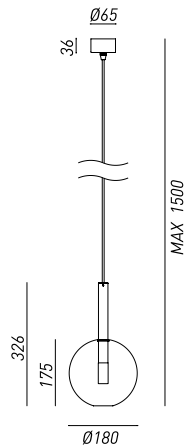

277.06.0NT
277.06.00T
1x Max 25W G9

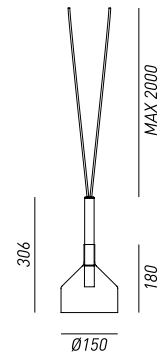

277.12.0NT
277.12.00T
1x Max 25W G9

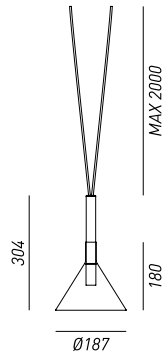

277.13.ONT
277.13.00T
1x Max 25W G9

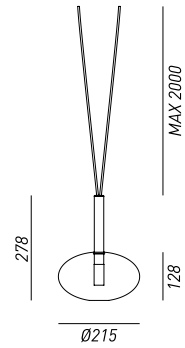

277.14.ONT
277.14.00T
1x Max 25W G9

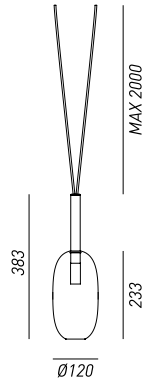

277.15.ONT
277.15.00T
1x Max 25W G9

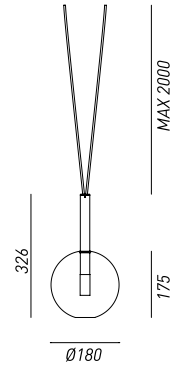

277.16.ONT
277.16.00T
1x Max 25W G9

accessori / accessories

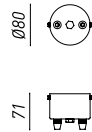

300.41.ON
300.41.00
*Rosone per soffitto o parete,
compreso di 2 tappi e 2 stringicavi.
Wall or ceiling canopy
with 2 screw tops and 2 cableglands.*



300.42.ON
300.42.00
*Rosone per cavo d'acciaio,
compreso di 2 tappi e 2 stringicavi.
Canopy for steel cable
with 2 screw tops and 2 cableglands.*



270.08.AA
 Kit per cavo d'acciaio Ø 3 mm.
 Kit for steel cable Ø 3 mm.

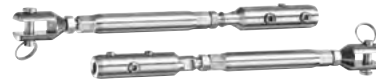
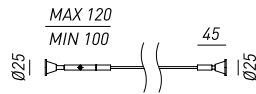

270.38.AA
 Kit per cavo d'acciaio, Ø 4 mm
 Kit for steel cable, Ø 4 mm

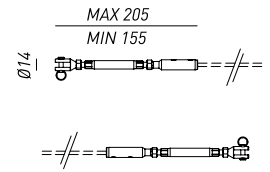

270.07.05
 Cavo d'acciaio Ø 3 mm, 5 m.
 Steel cable Ø 3 mm, 5 m.

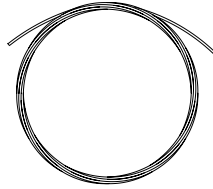

270.37.10
 Cavo d'acciaio Ø 4 mm, 10 m
 Steel cable Ø 4 mm, 10 m

270.37.20
 Cavo d'acciaio Ø 4 mm, 20 m
 Steel cable Ø 4 mm, 20 m

270.37.30
 Cavo d'acciaio Ø 4 mm, 30 m
 Steel cable Ø 4 mm, 30 m

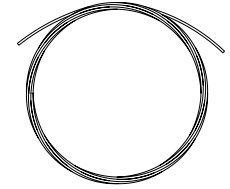

finiture montatura / frame finishes



OTTONE
 BRASS



OTTONE NATURALE
 NATURAL BRASS

vetro / glass



VETRO TRASPARENTE
 TRANSPARENT GLASS

LOFT





LA FORTE MATERICITÀ E LE RICERCATE CARATTERISTICHE ESTETICHE CONTRADDISTINGUONO QUESTE LAMPADE DA INTERNO REALIZZATE IN FERRO, ELEMENTI D'ARREDO DAL DISEGNO CONTEMPORANEO. IL PECULIARE SISTEMA A SNODI VOLUTAMENTE INDUSTRIALI, RISULTATO DELLA PERFETTA UNIONE TRA MATERIA E ARTIGIANALITÀ, CONSENTE IL MOVIMENTO DALL'ALTO AL BASSO. LA GRIGLIA, DISPONIBILE COME ACCESSORIO, ACCOMPAGNA LA LINEA ACCENTUANDO COSÌ IL RICHIAMO AL MONDO INDUSTRIALE. LA COLLEZIONE LOFT È COMPOSTA DA SOSPENSIONI, APPLIQUE, UNA LAMPADA DA TAVOLO E UNA PIANTANA, TUTTE NELLA FINITURA FERRO CON SNODI IN FUSIONE DI OTTONE.

WITH THEIR CONTEMPORARY STYLE, THESE IRON INDOOR LAMPS ARE CHARACTERIZED BY STRONG MATERIALS AND REFINED AESTHETIC FEATURES. THANKS TO THE MATERIALS USED AND OUR EXPERTISE IN HANDICRAFT, THE PECULIAR SYSTEM OF INDUSTRIAL JOINTS ALLOWS FOR THE MOVEMENT FROM TOP TO BOTTOM. THE GRID, AVAILABLE AS AN ACCESSORY, GIVES THE LAMP A MORE INDUSTRIAL FEEL. THE LOFT COLLECTION INCLUDES SUSPENSIONS, WALL MOUNTS, TABLE LAMPS AND FLOOR LAMPS, AVAILABLE IN IRON FINISH WITH BRASS JOINTS.















Lampade / lamps

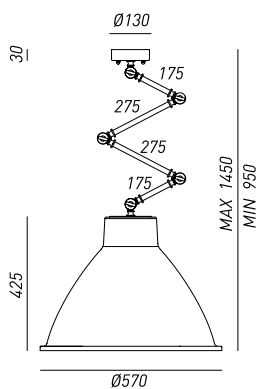

269.04.OF
1x Max 77W E27

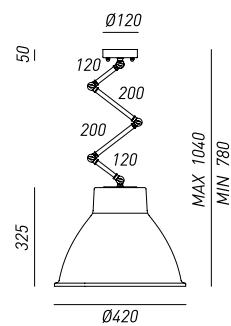

269.03.OF
1x Max 77W E27

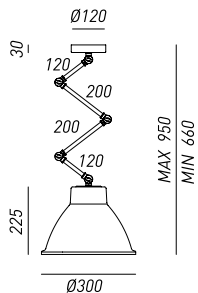

269.02.OF
1x Max 46W E27

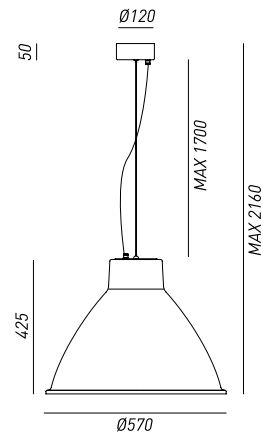

269.14.FF
1x Max 77W E27

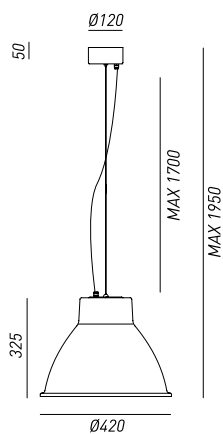

269.13.FF
1x Max 77W E27

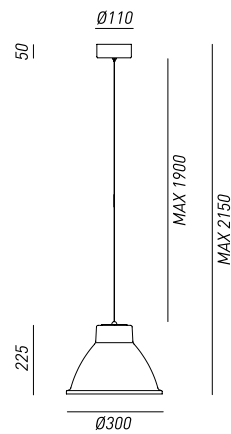

269.12.FF
1x Max 46W E27

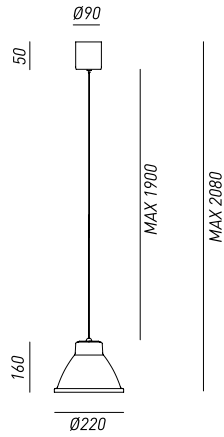

269.11.FF
1x Max 46W E27

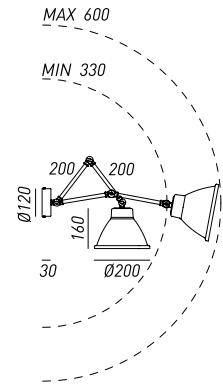

269.05.OF
1x Max 46W E27

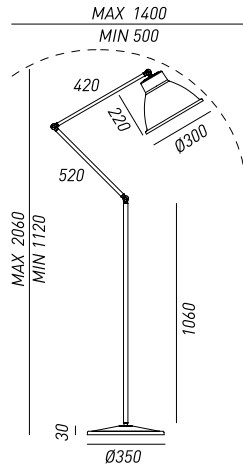

269.08.OF
1x Max 46W E27

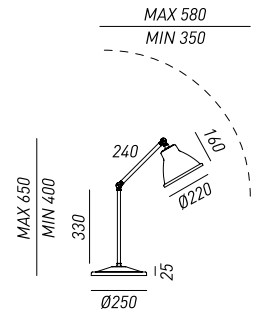

269.06.OF
1x Max 46W E27

dettaglio rosone / canopie's details



269.04
Ø 130 mm



269.02-03
Ø 120 mm

dettaglio rosoni / canopie's details



269.11-12-13-14
 Ø 90-110-120 mm

Istruzioni per l'installazione / Installation instructions

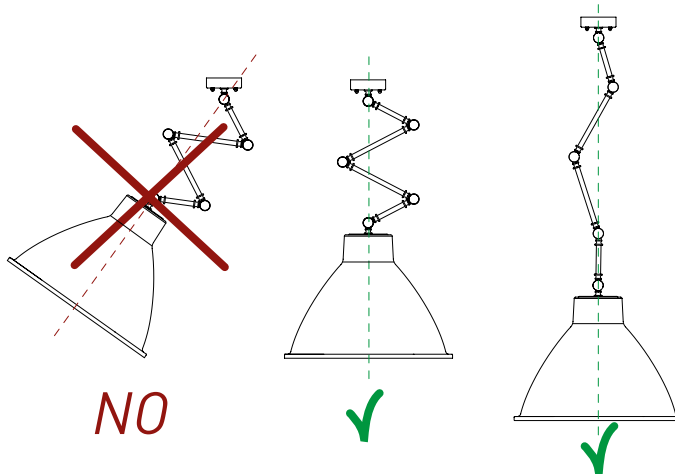

optional

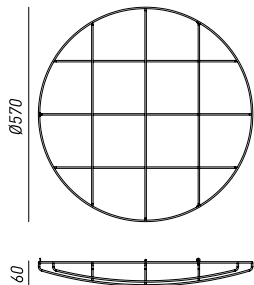

269.54.FF
 per articoli / for items
 269.04-14

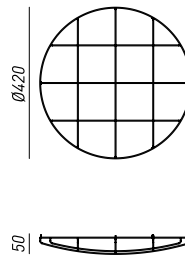

269.53.FF
 per articoli / for items
 269.03-13

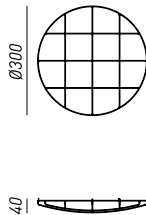

269.52.FF
 per articoli / for items
 269.02-08-12

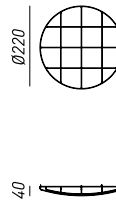

269.51.FF
 per articoli / for items
 269.05-06-11

finiture montatura / frame finishes



OTTONE
BRASS

finiture testa / shade finishes

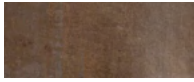

FERRO
IRON

REPORTER



REPORTER È UNA COLLEZIONE DI LAMPADE DA INTERNO DAL FORTE IMPATTO ESTETICO. OGGETTI CAPACI DI CARATTERIZZARE GLI AMBIENTI CON PARTICOLARI CAMBI DI PROSPETTIVA GRAZIE ALLA LORO DUTTILITÀ, E DI CREARE DISEGNI DI LUCE PERSONALIZZABILI. IL MOVIMENTO MECCANICO DELLA MONTATURA E DELLE SINGOLE TESTE PERMETTE DI INDIRIZZARE LA LUCE IN BASE ALLE PROPRIE ESIGENZE, FACENDO DI REPORTER UNA LAMPADA SIMBOLO DI FUNZIONALITÀ, E ALLO STESSO TEMPO DI ESTETICA E CONTEMPORANEITÀ. ELEMENTI CLASSICI E RIFERIMENTI INDUSTRIALI SI INCONTRANO IN UNA COLLEZIONE COMPOSTA DA SOSPENSIONI, APPLIQUE, UNA LAMPADA DA TAVOLO E UNA PIANTANA, DISPONIBILI NELLA FINITURA FERRO CON SNODI IN FUSIONE DI OTTONE.

THE REPORTER INDOOR LAMP COLLECTION OFFERS A STRONG AESTHETIC IMPACT. THESE LAMPS CAN CREATE DIFFERENT PERSPECTIVES THANKS TO THEIR FLEXIBILITY AND CAN CREATE CUSTOMIZABLE PATTERNS OF LIGHT. THE MECHANICAL MOVEMENT OF THE FRAME AND THE INDIVIDUAL LIGHTS ALLOW FOR THE FOCUSING OF THE LIGHTS TO MATCH YOUR NEEDS. THIS MAKES REPORTER A SYMBOL OF FUNCTIONALITY AND, AT THE SAME TIME, AESTHETICS AND MODERNITY. CLASSICAL ELEMENTS AND INDUSTRIAL REFERENCES MEET IN THIS COLLECTION OF SUSPENSIONS, WALL MOUNTS, TABLE LAMPS AND FLOOR LAMPS. THEY ARE AVAILABLE IN IRON FINISHES WITH BRASS JOINTS.











Lampade / lamps

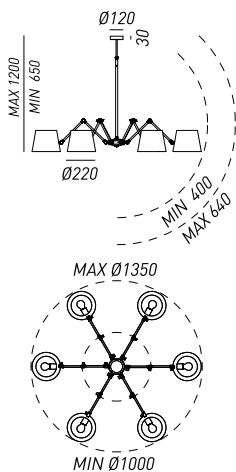

271.04.OF
6x Max 46W E27

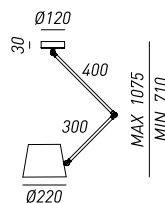

271.01.OF
1x Max 46W E27

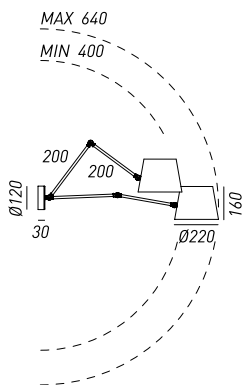

271.05.OF
1x Max 46W E27

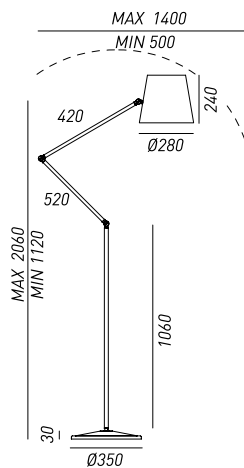

271.08.OF
1x Max 77W E27

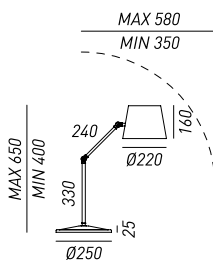

271.06.OF
1x Max 46W E27

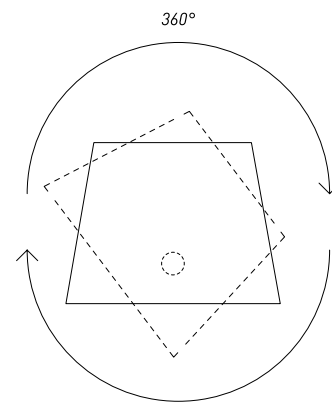

Rotazione della campana: 360°
Shade rotation: 360°

dettaglio rosoni / canopie's details



271.01-04
Ø 120 mm

finiture montatura / frame finishes



OTTONE
BRASS

finiture testa / shade finishes

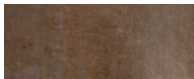

FERRO
IRON

OFFICINA



ASPETTO RUVIDO E GREZZO
MA DI GRAN RICERCATEZZA:
QUESTE LE CARATTERISTICHE DI
OFFICINA, COLLEZIONE DAL GUSTO
TIPICAMENTE INDUSTRIAL IN GRADO
DI CREARE ATMOSFERE RAFFINATE
NEGLI AMBIENTI IN CUI SI COLLOCA.
PRODOTTE IN FERRO, QUESTE
LAMPADE RAPPRESENTANO UN
OMAGGIO AD UNO STILE MINIMAL ED
ESSENZIALE.

ROUGH AND RAW LOOK WITH GREAT
SOPHISTICATION: THESE ARE THE
CHARACTERISTICS OF OFFICINA,
COLLECTION OF A TYPICALLY
INDUSTRIAL TASTE ABLE TO CREATE
A SOPHISTICATED ATMOSPHERE IN
THE ENVIRONMENTS IN WHICH IT IS
PLACED. PRODUCED IN IRON, THESE
LAMPS ARE A TRIBUTE TO A MINIMAL
AND ESSENTIAL STYLE.













NEW YORK TIMES SQUARE
Rockefeller
Greenwich Vill
5^{TH AVENUE}
CENTRAL PARK
Tribec
7^{TH AVENUE} Broadway
BROOKLYN BRIDGE 34
PARK AVE ROOSEVELT BRYANT PAR
Columbus Circle
Union Square SOH

lampade / lamps

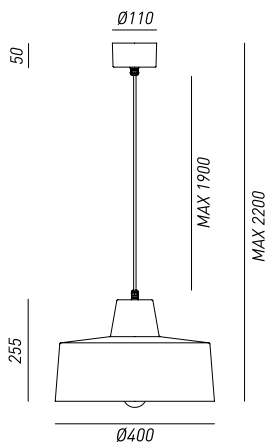

268.06.FF
1x Max 77W E27

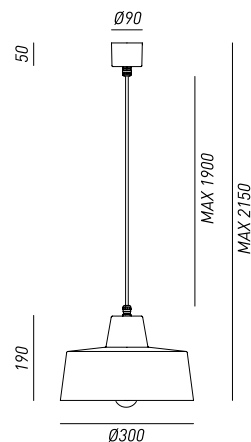

268.05.FF
1x Max 46W E27

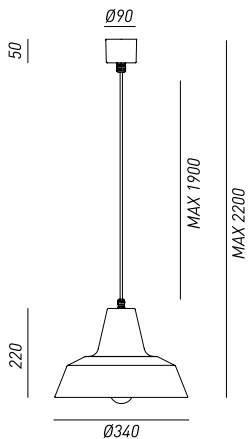

268.10.FF
1x Max 77W E27

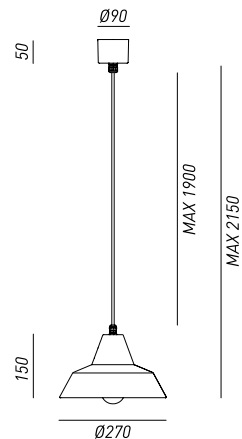

268.09.FF
1x Max 46W E27

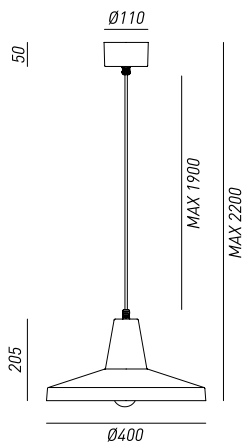

268.02.FF
1x Max 77W E27

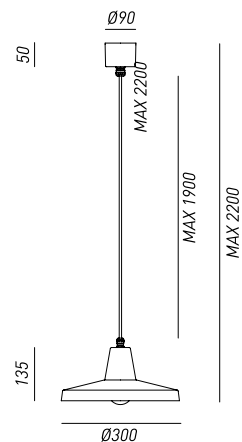
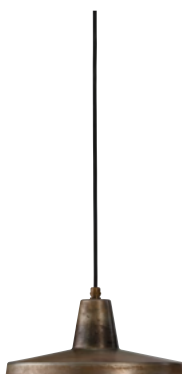

268.01.FF
1x Max 46W E27

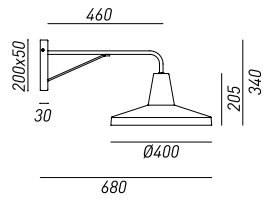

268.04.FF
1x Max 77W E27 

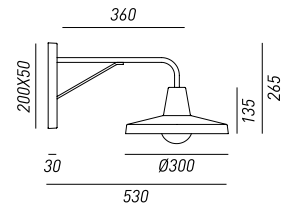

268.03.FF
1x Max 46W E27 

dettaglio rosoni / canopie's details



268.02-06
Ø 110 mm



268.01-05-09-10
Ø 90 mm

finiture montatura / frame finishes

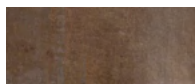

FERRO
IRON

finiture testa / shade finishes

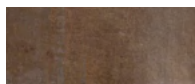

FERRO
IRON

KHONUS



FORME SEMPLICI E LINEARI
ISPIRANO UN DESIGN FUNZIONALE.
COSÌ NASCE KHONUS: UNA SERIE
DI LAMPADIE CONICHE REALIZZATE
IN FERRO ANTICATO, IN GRADO DI
RIFLETTERE LA LUCE SIA VERSO
IL BASSO CHE VERSO L'ALTO
ILLUMINANDO INTERAMENTE
L'AMBIENTE. DISPONIBILI IN TRE
MISURE DIVERSE, POSSONO ESSERE
DISPOSTE SINGOLARMENTE OPPURE
INSIEME VALORIZZANDO LA LORO
ESSENZA.

SIMPLE AND LINEAR SHAPES
INSPIRE A FUNCTIONAL DESIGN.
THIS IS KHONUS: A SERIES OF CONE
SHAPED LAMPS MADE OF ANTIQUE
IRON, CAPABLE OF REFLECTING
LIGHT BOTH DOWNWARDS AND
UPWARDS ENTIRELY ILLUMINATING
THE SURROUNDINGS. AVAILABLE
IN THREE DIFFERENT SIZES, CAN
BE ARRANGED INDIVIDUALLY OR
TOGETHER ENHANCING THEIR
ESSENCE.







lampade / lamps

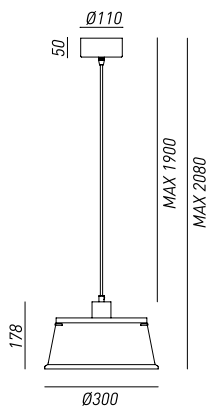

256.01.FF
1x Max 77W E27

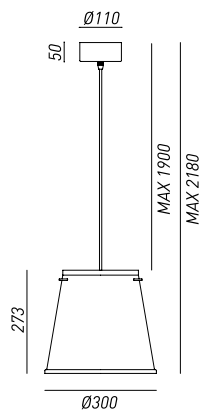

256.02.FF
1x Max 77W E27

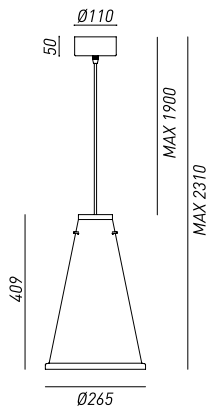

256.03.FF
1x Max 77W E27

dettaglio rosoni / canopies details



256.01-02-03
Ø 110 mm

finiture montatura / frame finishes

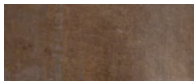

FERRO
IRON

finiture testa / shade finishes

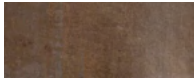

FERRO
IRON

GIRASOLI



DESIGN MINIMALISTA ISPIRATO A
FORME GEOMETRICHE SEMPLICI
PER UNA COLLEZIONE DALLA
CONFORMAZIONE CILINDRICA,
RIGOROSA E PRIMORDIALE.
REALIZZATE IN OTTONE O FERRO,
QUESTE LAMPADE DAL GRANDE
FASCINO SONO CARATTERIZZATE
DA LINEE PULITE ED ESSENZIALI
CHE RISALTANO LA PUREZZA DELLA
MATERIA, PROTAGONISTA ASSOLUTA
DELLA SERIE GIRASOLI.

MINIMALIST DESIGN INSPIRED BY
SIMPLE GEOMETRIC SHAPES FOR
A COLLECTION OF CYLINDRICAL,
RIGOROUS AND PRIMORDIAL SHAPES.
MADE OF BRASS OR IRON, THESE
GLAMOROUS LAMPS HAVE CLEAN
AND SIMPLE LINES THAT HIGHLIGHT
THE PURITY OF THE MATERIAL, AN
ABSOLUTE PROTAGONIST OF THE
GIRASOLI SERIES.













lampade / lamps

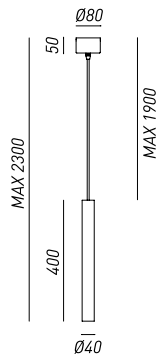

208.31.ON
208.31.OO
208.31.FF
1x Max 25W G9

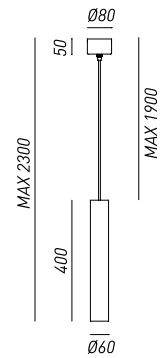

208.33.N1
208.33.O1
208.33.F1
1x Max 50W GU10

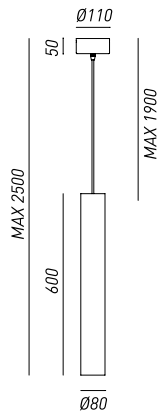

208.34.ON
208.34.OO
208.34.FF
1x Max 50W E27 PAR20

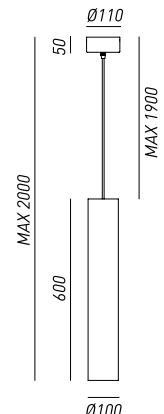

208.35.ON
208.35.OO
208.35.FF
1x Max 75W E27 PAR30
*lampada Ø Max 96 mm
bulb Ø Max 96 mm

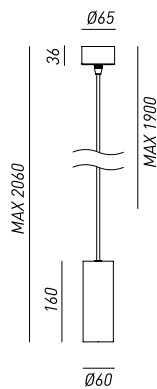

214.21.ON
214.21.FF
214.21.OO
1x Max 35W GU10

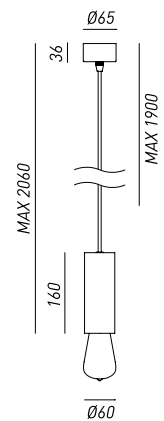

214.20.ON
214.20.FF
214.20.OO
1x Max 57W E27

lampade / lamps

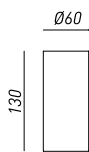

208.03.01
208.03.F1
208.03.N1
1x Max 35W GU10

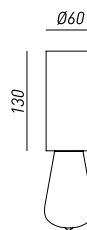

208.03.02
208.03.F2
208.03.N2
1x Max 57W E27

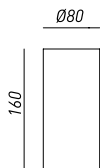

208.02.00
208.02.FF
208.02.FN
1x Max 50W E27 PAR20



208.01.00
208.01.FF
208.01.ON
1x Max 75W E27PAR30
*lampada Ø Max 96 mm
bulb Ø Max 96 mm

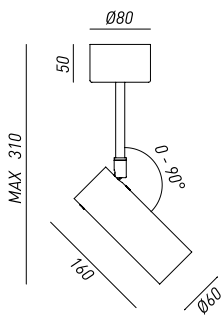

214.10.00
214.10.ON
214.10.FF
1x Max 35W GU10

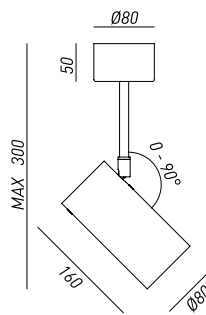

214.08.FF
214.08.ON
214.08.00
1x Max 50W E27 PAR20

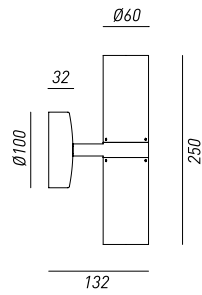

214.26.00
 214.26.0N
 214.26.FF
 2x Max 35W GU10 

dettaglio rosoni / canopie's details



208.34-35
 Ø 110 mm H 50 mm



208.31-33
 Ø 80 mm H 50 mm

finiture montatura / frame finishes



OTTONE
 BRASS



FERRO
 IRON



OTTONE NATURALE
 NATURAL BRASS

finiture testa / shade finishes



OTTONE
 BRASS



FERRO
 IRON



OTTONE NATURALE
 NATURAL BRASS

LONDON





LO STILE INTERNAZIONALE
INCONTRA LE LINEE DELLA
TRADIZIONE CARATTERIZZANDO
LONDON, COLLEZIONE COMPOSTA
DA SOSPENSIONI, APPLIQUE E
PLAFONIERE. LA STRUTTURA,
REALIZZATA IN FERRO ANTICATO,
È RESA PERCEPIBILE DALLE
TRASPARENZE DEL VETRO CREANDO
COSÌ INASPETTATI CAMBI DI VISIONE
IN UN'ATMOSFERA LEGGERA E DI
GRANDE FASCINO.

THE INTERNATIONAL STYLE MEETS
THE LINES OF THE TRADITION THUS
OUTLINING LONDON, A COLLECTION
COMPOSED OF SUSPENSIONS,
APPLIQUES AND CEILING LAMPS.
THE STRUCTURE, MADE OF
ANTIQUÉ IRON, IS PERCEPTIBLE
BY THE TRANSPARENCY OF GLASS,
CREATING UNEXPECTED CHANGES
OF VISION IN A SOFT AND OF GREAT
CHARM ATMOSPHERE.























lampade / lamps

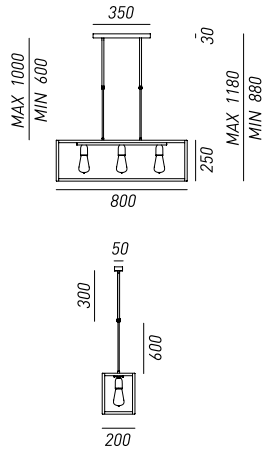

205.04.FF
3x Max 77W E27

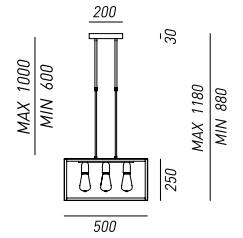

205.05.FF
4x Max 77W E27

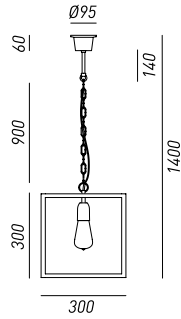

205.02.FF
1x Max 77W E27

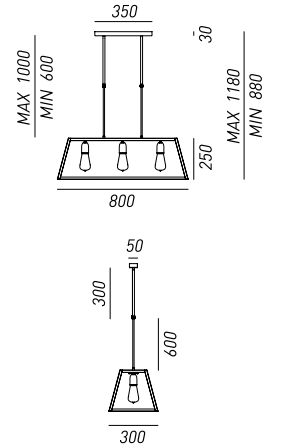

205.24.FF
3x Max 77W E27

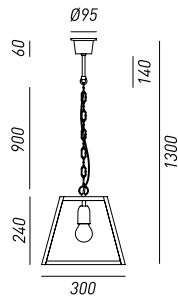

205.21.FF
1x Max 77W E27

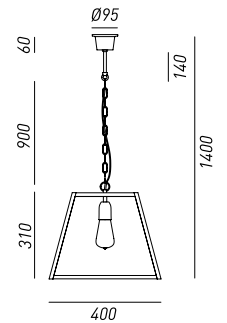

205.22.FF
1x Max 77W E27

lampade / lamps

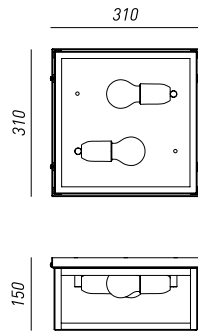

205.06.FF
2x Max 46W E27 

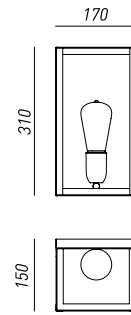

205.09.FF
1x Max 46W E27 

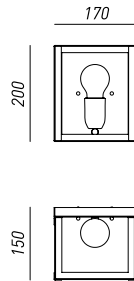

205.08.FF
1x Max 46W E27 

dettaglio rosoni / canopie's details



205.04-24
L 350 mm H 30 mm

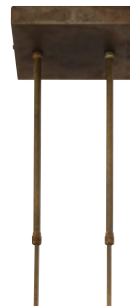

205.05
L 200 mm H 30 mm



205.02-22-21
Ø 95 mm H 60 mm

finiture montatura / frame finishes



FERRO
IRON



VETRO TRASPARENTE
TRANSPARENT GLASS

GALILEO







IL TRATTO GRAFICO DECISO E LA PERFETTA MEZZA SFERA CARATTERIZZANO QUESTA COLLEZIONE DI LAMPADE, CHE SI CONFIGURA COME UN OMAGGIO ALLA RIVOLUZIONE ASTRONOMICA. IL CONTRASTO TRA L'ESTERNO IN OTTONE O FERRO E L'INTERNO REALIZZATO IN FOGLIA ORO, ARGENTO O RAME, CONFERISCE A QUESTO PRODOTTO UN VALORE ESTETICO DI GRANDE EFFETTO VISIVO. DISPONIBILE CON ESTERNO IN OTTONE O FERRO NEI DIAMETRI 30, 40, 60 CM, E CON ESTERNO IN FERRO NEL DIAMETRO 80 CM.

THE FIRM GRAPHIC LINE AND THE PERFECT HALF SPHERE CHARACTERIZE THIS COLLECTION OF LAMPS, DESIGNED AS A TRIBUTE TO THE ASTRONOMICAL REVOLUTION. THE CONTRAST BETWEEN THE OUTER LOOK MADE OF BRASS OR IRON AND THE INTERIOR ONE DONE WITH GOLD, SILVER OR COPPER FOIL, ASCRIBES THIS PRODUCT AN AESTHETIC VALUE OF GREAT VISUAL EFFECT. AVAILABLE IN BRASS OR IRON EXTERIOR FOR DIAMETERS 30, 40, 60 CM AND IN IRON EXTERIOR FOR DIAMETER 80 CM.



ESEMPI DI FINITURE / EXAMPLES OF FINISHES

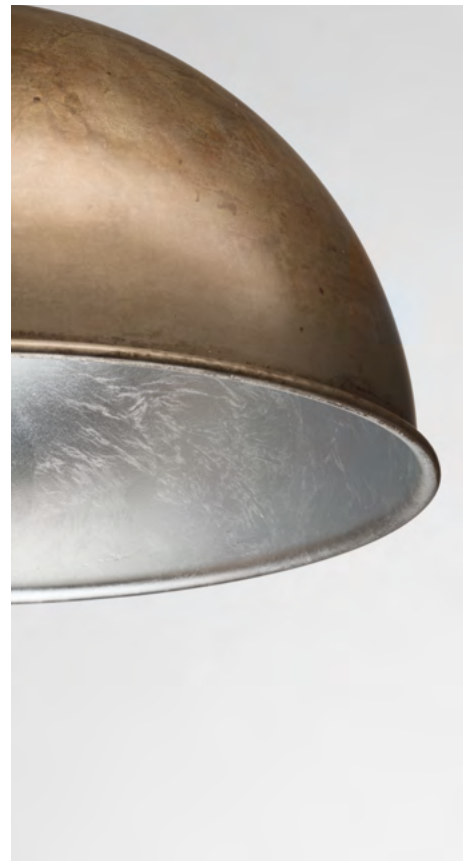
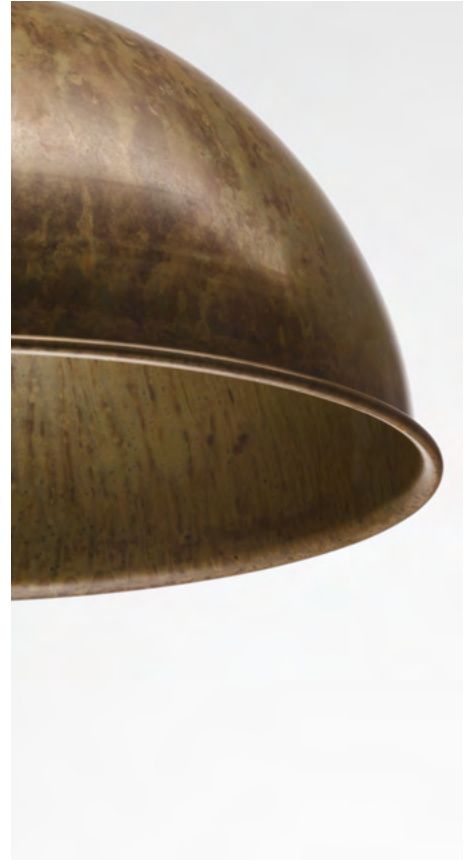

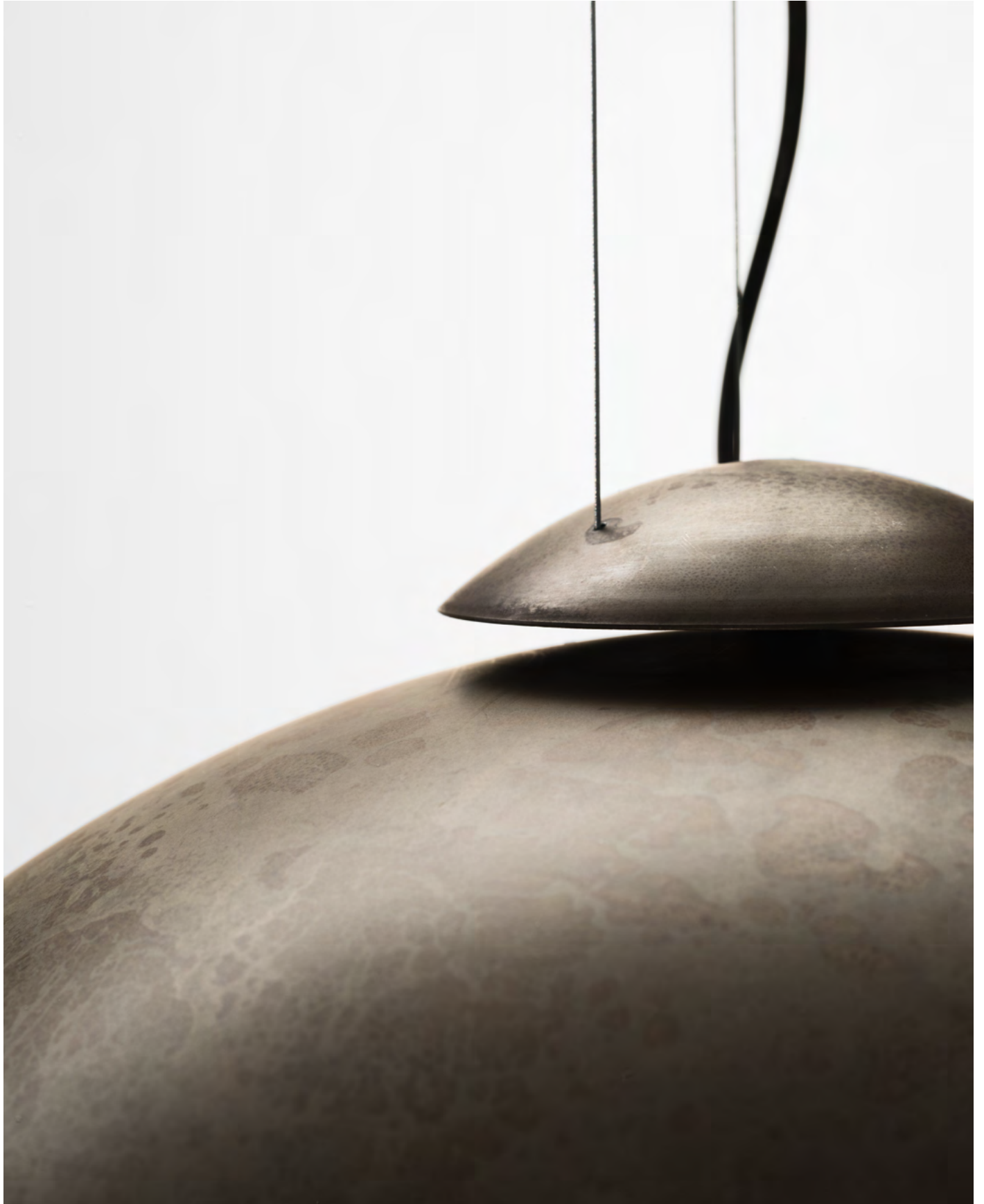



lampade / lamps

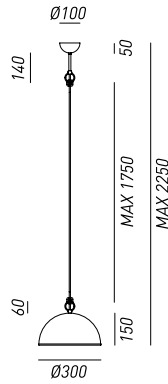

251.07.00 251.07.FF
 251.07.094 251.07.F94
 251.07.095 251.07.F95
 251.07.096 251.07.F96
 1x Max 46W E27



251.08.00 251.08.FF
 251.08.094 251.08.F94
 251.08.095 251.08.F95
 251.08.096 251.08.F96
 1x Max 77W E27

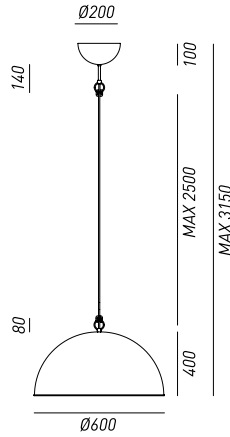

251.10.00 251.10.FF
 251.10.094 251.10.F94
 251.10.095 251.10.F95
 251.10.096 251.10.F96
 1x Max 77W E27

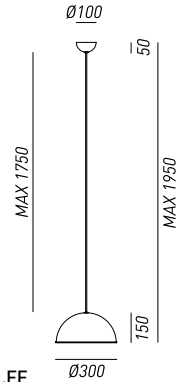

251.01.00 251.01.FF 251.31.00 251.31.FF
 251.01.094 251.01.F94 251.31.094 251.31.F94
 251.01.095 251.01.F95 251.31.095 251.31.F95
 251.01.096 251.01.F96 251.31.096 251.31.F96
 1x Max 46W E27 LED 8,7W 3000K

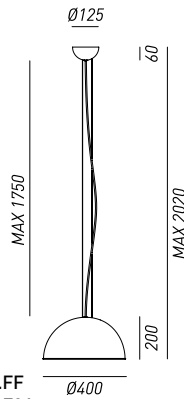

251.02.00 251.02.FF 251.32.00 251.32.FF
 251.02.094 251.02.F94 251.32.094 251.32.F94
 251.02.095 251.02.F95 251.32.095 251.32.F95
 251.02.096 251.02.F96 251.32.096 251.32.F96
 1x Max 77W E27 LED 20W 3000K

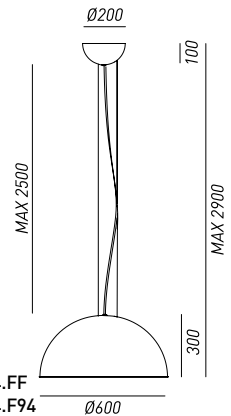

251.04.00 251.04.FF 251.34.00 251.34.FF
 251.04.094 251.04.F94 251.34.094 251.34.F94
 251.04.095 251.04.F95 251.34.095 251.34.F95
 251.04.096 251.04.F96 251.34.096 251.34.F96
 1x Max 77W E27 LED 30W 3000K

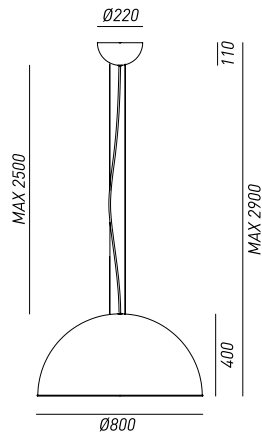

251.06.FF
251.06.F94
251.06.F95
251.06.F96
1x Max 77W E27

251.36.FF
251.36.F94
251.36.F95
251.36.F96
LED 43W 3000K



210.02.01 210.02.F1
1x Max 77W E27
210.12.00 210.12.FF
LED 13W 3000K



210.03.01 210.03.F1
1x Max 77W E27
210.13.00 210.13.FF
LED 8,7W 3000K

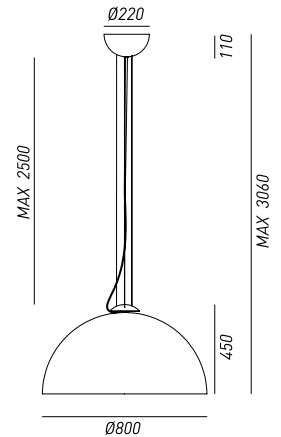

257.24.FF
LED 43W 3000K
257.34.FF
4x Max 46W E27
IP55

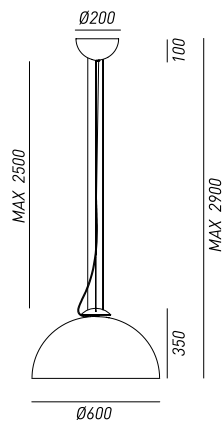

257.23.FF
LED 30W 3000K
257.33.FF
3x Max 46W E27
IP55

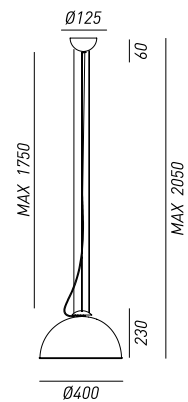

257.22.FF
LED 20W 3000K
257.32.FF
2x Max 46W E27
IP55

dettaglio rosoni / canopie's details

251.08
Ø 125 mm H 60 mm



251.10
Ø 200 mm H 100 mm



251.06
257.04
Ø 220 mm H 110 mm



251.02
257.02
Ø 125 mm H 60 mm



251.04
257.03
Ø 200 mm H 100 mm

descrizione codici / codes description

Ø 300 mm 251.01 251.07 | Ø 400 mm 251.02 251.08 | Ø 600 mm 251.04 251.10

- 00** ESTERNO OTTONE - INTERNO OTTONE / BRASS EXTERIOR - BRASS INTERIOR
- 094** ESTERNO OTTONE - INTERNO FOGLIA RAME / BRASS EXTERIOR - COPPER FOIL INTERIOR
- 095** ESTERNO OTTONE - INTERNO FOGLIA ARGENTO / BRASS EXTERIOR - SILVER FOIL INTERIOR
- 096** ESTERNO OTTONE - INTERNO FOGLIA ORO / BRASS EXTERIOR - GOLD FOIL INTERIOR

- FF** ESTERNO FERRO - INTERNO FERRO / IRON EXTERIOR - IRON INTERIOR
- F94** ESTERNO FERRO - INTERNO FOGLIA RAME / IRON EXTERIOR - COPPER FOIL INTERIOR
- F95** ESTERNO FERRO - INTERNO FOGLIA ARGENTO / IRON EXTERIOR - SILVER FOIL INTERIOR
- F96** ESTERNO FERRO - INTERNO FOGLIA ORO / IRON EXTERIOR - GOLD FOIL INTERIOR

Ø 800 mm 251.06

- FF** ESTERNO FERRO - INTERNO FERRO / IRON EXTERIOR - IRON INTERIOR
- F94** ESTERNO FERRO - INTERNO FOGLIA RAME / IRON EXTERIOR - COPPER FOIL INTERIOR
- F95** ESTERNO FERRO - INTERNO FOGLIA ARGENTO / IRON EXTERIOR - SILVER FOIL INTERIOR
- F96** ESTERNO FERRO - INTERNO FOGLIA ORO / IRON EXTERIOR - GOLD FOIL INTERIOR

POGGIO





LA RICERCATA E COMPLESSA LAVORAZIONE DELLA COLLEZIONE POGGIO, REALIZZATA IN OTTONE E FERRO, È VOLTA ALLA CREAZIONE DI OGGETTI IN GRADO DI RACCHIUDERE L'EREDITÀ CULTURALE DEL DESIGN ITALIANO DEGLI ANNI '40. FORME PULITE E LIBERE DA OGNI COSTRIZIONE CARATTERIZZANO QUESTE LAMPADE, RAPPRESENTATIVE DI UN HERITAGE PURO E AUTENTICO.

THE SOPHISTICATED AND COMPLEX PROCESSING OF THE BRASS AND IRON POGGIO COLLECTION IS A CREATION OF OBJECTS THAT CAN ENCOMPASS THE CULTURAL HERITAGE OF ITALIAN DESIGN OF THE 40S. WITH THEIR CLEAN AND CONSTRAINT-FREE SHAPES, THESE LAMPS REPRESENT A PURE AND AUTHENTIC HERITAGE.







lampade / lamps

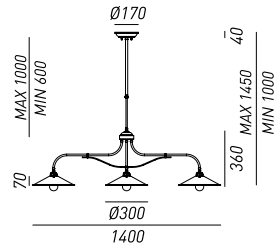

203.11.00
203.11.0F
3x Max 77W E27

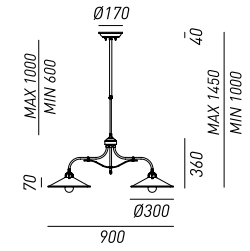

203.10.00
203.10.0F
2x Max 77W E27

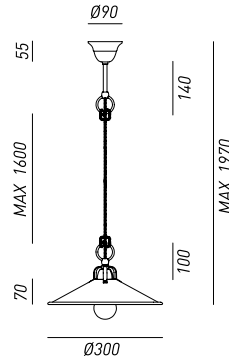

203.09.00
203.09.0F
1x Max 77W E27

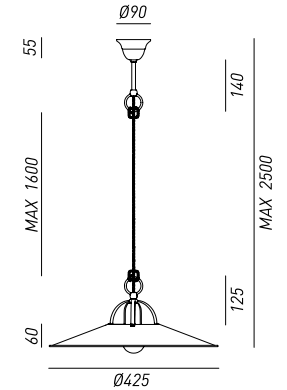

203.12.00
203.12.0F
1x Max 77W E27

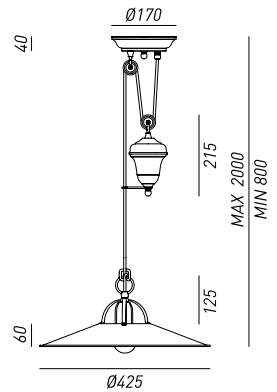

203.13.00
203.13.0F
1x Max 77W E27

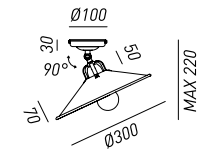

203.02.00
203.02.0F
1x Max 77W E27

dettaglio rosoni / canopie's details



203.10-11
Ø 170 mm H 40 mm



203.09-12
Ø 90 mm H 55 mm



203.13
Ø 170 mm H 40 mm

finiture montatura / frame finishes



OTTONE
BRASS

finiture testa / shade finishes



OTTONE
BRASS



FERRO
IRON

CANTINA





VOLUTAMENTE ISPIRATE
ALL'ARREDAMENTO TIPICO
DI CANTINE E LABORATORI
ARTIGIANALI, QUESTE LAMPADE
SONO CARATTERIZZATE DA PIATTI
LEVIGATI IN OTTONE O FERRO
ANTICATO. L'ESSENZIALITÀ DELLE
FORME È ELEMENTO DISTINTIVO
DELLA COLLEZIONE CANTINA:
PRODOTTI MODERNI E VERSATILI
ADATTABILI AD OGNI AMBIENTE.

PURPOSELY INSPIRED BY
FURNISHINGS TYPICAL OF CELLARS
AND WORKSHOPS, THESE LAMPS
ARE CHARACTERIZED BY FLAT
POLISHED BRASS OR ANTIQUE IRON.
THE SIMPLICITY OF THE FORMS IS
THE DISTINCTIVE ELEMENT OF THE
COLLECTION CANTINA: MODERN AND
VERSATILE PRODUCTS ADAPTABLE
TO ANY ENVIRONMENT.





lampade / lamps

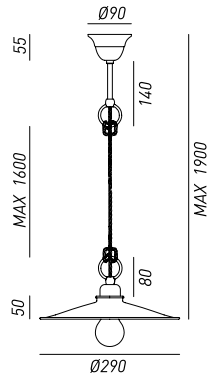

201.10.00
201.10.FF
1x Max 57W E27

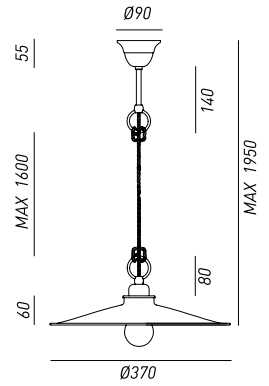

201.11.00
201.11.FF
1x Max 57W E27

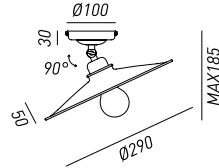

201.02.00
201.02.FF
1x Max 57W E27

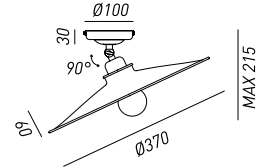

201.03.00
201.03.FF
1x Max 57W E27

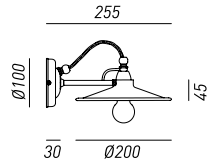

201.04.00
201.04.FF
1x Max 46W E14

dettaglio rosoni / canopie's details



201.10-11
Ø 90 mm H 55 mm

finiture montatura / frame finishes



OTTONE
BRASS

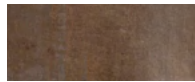

FERRO
IRON

finiture testa / shade finishes



OTTONE
BRASS

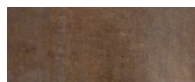

FERRO
IRON

CASCINA



L'IMPATTO VISIVO FORTEMENTE
MATERICO E IL RIGOROSO DISEGNO
CARATTERIZZANO I PRODOTTI
DELLA COLLEZIONE CASCINA.
REALIZZATE IN OTTONE E/O FERRO
ANTICATO, QUESTE LAMPADE
ROMPONO LA LINEARITÀ DEGLI
AMBIENTI STRAVOLGENDO I CANONI
SCENOGRAFICI CLASSICI.

THE HIGHLY MATERIAL VISUAL
IMPACT AND STRICT DESIGN
CHARACTERIZE THE PRODUCTS OF
THE CASCINA COLLECTION. MADE
OF BRASS AND/OR ANTIQUE IRON,
THESE LAMPS BREAK THE LINEARITY
OF THE ENVIRONMENTS TWISTING
THE CLASSICAL THEATRICAL
CANONS.





bauhaus de stijl art
deco impressionism
baroque cubism pop
expressionism post
impressionism nabis
fauvism modernism
magic photorealism
nouveau rococo neo
expressionism arts &
crafts precisionism
minimalism futurism
realism abstrac
surrealism symbolis





lampade / lamps

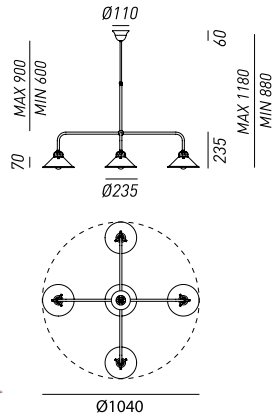

204.25.00
5x Max 46W E27

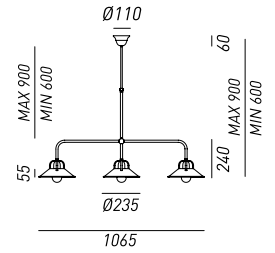

204.10.00
3x Max 46W E27

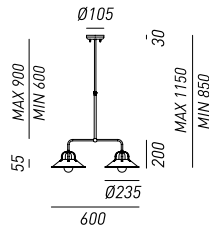

204.09.00
2x Max 46W E27

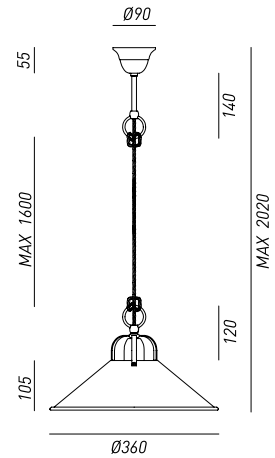

204.08.00
204.08.0F
1x Max 46W E27

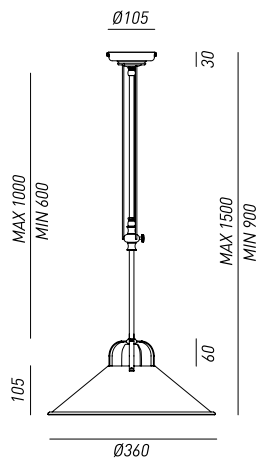

204.11.00
204.11.0F
1x Max 46W E27

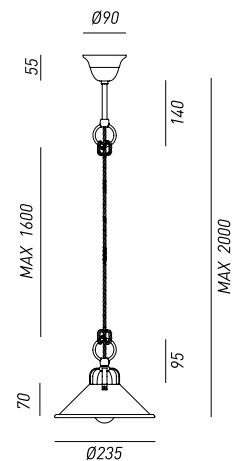

204.07.00
1x Max 46W E27

lampade / lamps

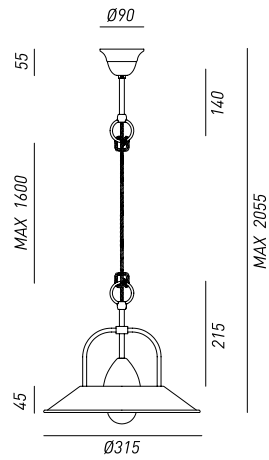

204.12.00
204.12.0F
1x Max 46W E27

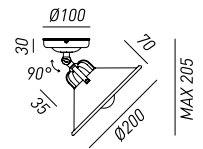

204.23.00
1x Max 46W E14

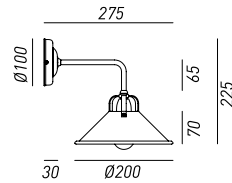

204.05.00
1x Max 46W E14

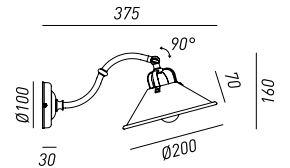

204.04.00
1x Max 46W E14

dettaglio rosoni / canopie's details



204.10-25
Ø 110 mm H 60 mm



204.09
Ø 100 mm H 30 mm



204.08-07-12
Ø 90 mm H 55 mm



204.11
Ø 105 mm H 30 mm

finiture montatura / frame finishes



OTTONE
BRASS

finiture testa / shade finishes



OTTONE
BRASS

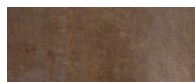

FERRO
IRON

COUNTRY



LINGUAGGIO COUNTRY
INTERNAZIONALE E TRADIZIONE
MILLENNARIA DEL VETRO DI MURANO,
GRANDE ESPRESSIONE DEL MADE
IN ITALY, SI FONDONO ALLA
PERFEZIONE NELLA COLLEZIONE
COUNTRY. PRODOTTE IN OTTONE E
VETRO SOFFIATO BIANCO, QUESTE
LAMPADRE SONO PECULIARMENTE
CARATTERIZZATE DAL BORDO
RIBRUCIATO MARRONE.

INTERNATIONAL COUNTRY
LANGUAGE AND MILLENNIAL
TRADITION OF MURANO GLASS,
GREAT EXPRESSION OF MADE IN
ITALY, BLEND PERFECTLY INTO THE
COUNTRY COLLECTION. PRODUCED
IN BRASS WITH WHITE BLOWN
GLASS, THESE
LAMPS ARE PARTICULARLY
CHARACTERIZED BY A BURNT BROWN
RIM.







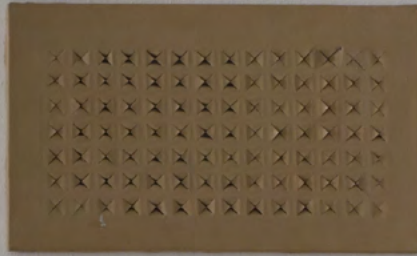

Lampade / lamps

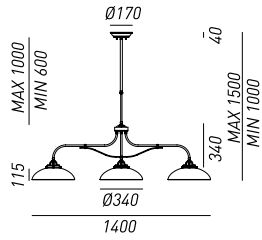

080.09.OV
3x Max 77W E27

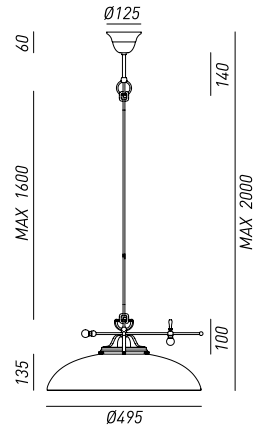

080.10.OV
1x Max 77W E27

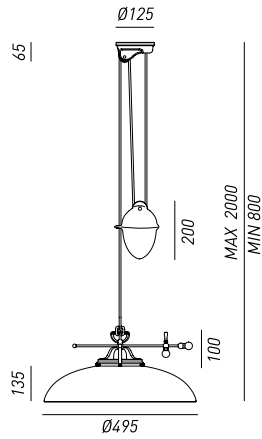

080.11.OV
1x Max 77W E27

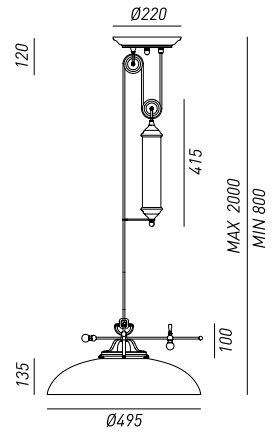

080.12.OV
1x Max 77W E27

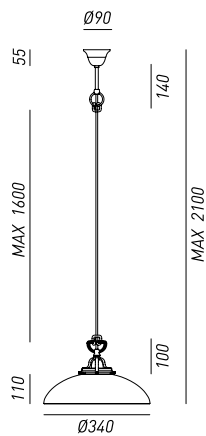

082.10.OV
1x Max 77W E27

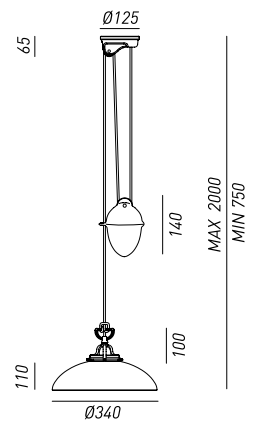

082.11.OV
1x Max 77W E27

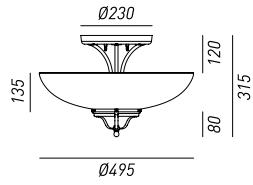

080.02.OV
3x Max 46W E27

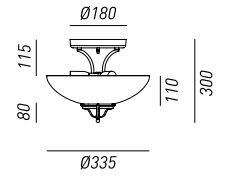

082.02.OV
3x Max 46W E14

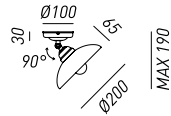

082.23.OV
1x Max 46W E14

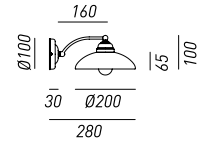

082.17.OV
1x Max 46W E14

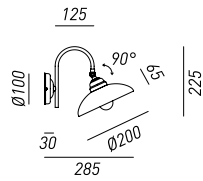

082.19.OV
1x Max 46W E14

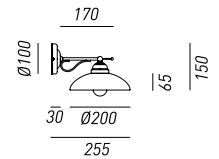

082.14.OV
1x Max 46W E14

dettaglio rosoni / canopie's details

080.12
Ø 220 mm H 120 mm



080.09
Ø 170 mm H 40 mm



080.10
Ø 110 mm H 60 mm



082.10
Ø 90 mm H 55 mm



080.11
082.11
Ø 125 mm H 65 mm

finiture montatura / frame finishes



OTTONE
BRASS



CERAMICA
CERAMIC

finiture testa / shade finishes



VETRO
GLASS





lampade / lamps

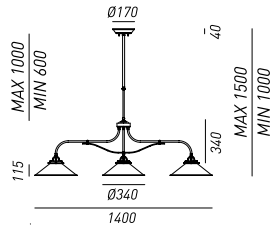

081.09.OV
3x Max 77W E27

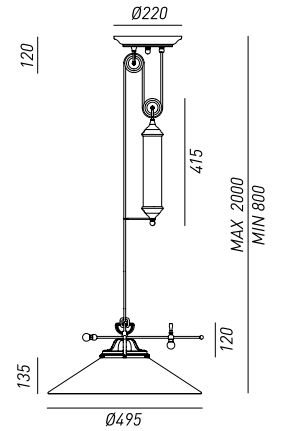

083.12.OV
1x Max 77W E27

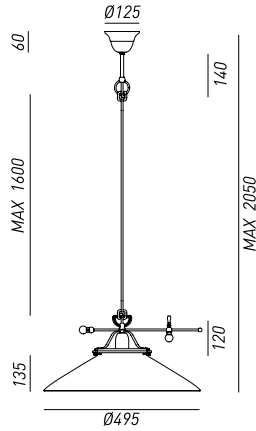

083.10.OV
1x Max 77W E27

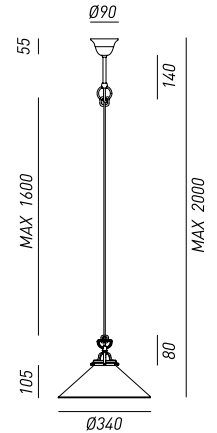

081.10.OV
1x Max 77W E27

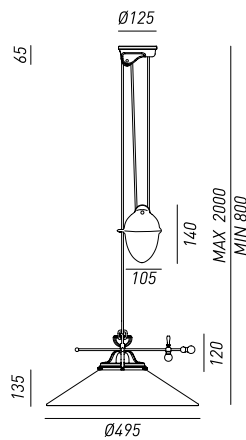

083.11.OV
1x Max 77W E27

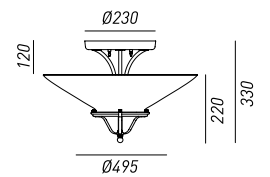

083.02.OV
3x Max 46W E27

lampade / lamps

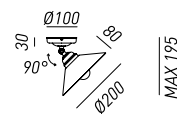
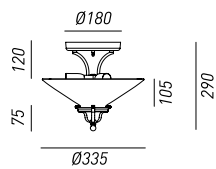

081.02.OV
3x Max 46W E14

081.23.OV
1x Max 46W E14

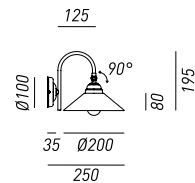
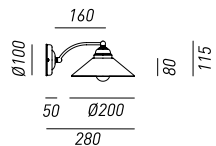

081.17.OV
1x Max 46W E14

081.19.OV
1x Max 46W E14

dettaglio rosoni / canopies' details



081.10
Ø 90 mm H 55 mm



083.10
Ø 125 mm H 60 mm



083.12
 Ø 220 mm H 120 mm



080.09
 Ø 170 mm H 40 mm



083.11
 Ø 125 mm H 65 mm

finiture montatura / frame finishes



OTTONE
 BRASS



CERAMICA
 CERAMIC

finiture testa / shade finishes



VETRO
 GLASS

MINI





MINI È UNA COLLEZIONE DI APPLIQUE
E FARETTI REALIZZATI IN CERAMICA
E OTTONE ANTICATO. IL PROFILO
RICERCATO CARATTERIZZA QUESTI
PRODOTTI COME ELEMENTI DI UN
DESIGN GIOVANE E ATTUALE.

MINI IS A COLLECTION OF SCONCES
AND SPOTLIGHTS MADE OF
CERAMICS AND ANTIQUE BRASS.
THE REFINED PROFILE CHARACTERIZES
THESE PRODUCTS AS PART OF A
YOUNG AND CURRENT DESIGN.







Lampade / lamps

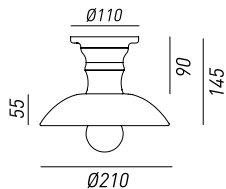

064.02.OC
1x Max 46W E27

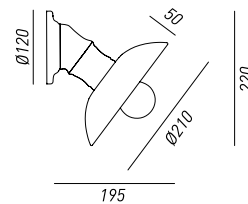

064.04.OC
1x Max 46W E27

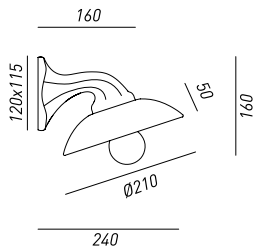

064.05.OC
1x Max 46W E27

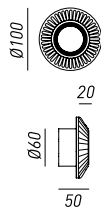

208.07.00
1x Max 35W GU5.3
208.17.00
1x Max 35W GU10

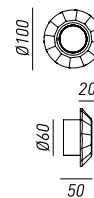

208.09.00
1x Max 35W GU5.3
208.19.00
11x Max 35W GU10

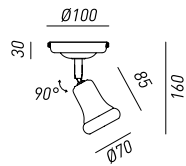

208.23.00
1x Max 35W GU10 

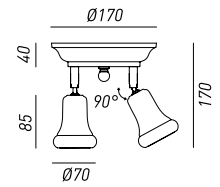

208.22.00
2x Max 35W GU10 

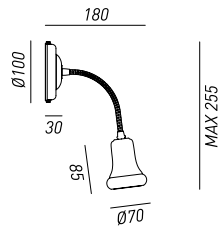

208.20.00
1x Max 35W GU10 

finiture montatura / frame finishes



OTTONE
BRASS



CERAMICA
CERAMIC

finiture testa / shade finishes



OTTONE
BRASS

FIORI DI PIZZO





I RICAMI SAPIENTEMENTE TRAFORATI SULLE PREZIOSE CERAMICHE DI BASSANO CONFERISCONO UN GRANDE VALORE ESTETICO ALLE LAMPADE DELLA COLLEZIONE FIORI DI PIZZO, SIMBOLO DI UN CLASSICISMO RIVISITATO IN CHIAVE MODERNA. LA RICERCATA LAVORAZIONE CONSENTE, IN FASE DI ILLUMINAZIONE, LA CREAZIONE DI GIOCHI DI LUCE SULLE PARETI PROIETTANDO FIORI E DECORI.

THE EMBROIDERIES EXPERTLY DRILLED ON PRECIOUS CERAMICS OF BASSANO GIVE A GREAT AESTHETIC VALUE TO THE LAMPS OF THE FIORI DI PIZZO COLLECTION, A SYMBOL OF A MODERN REINTERPRETATION OF CLASSICISM. THE SOPHISTICATED PROCESSING ALLOWS, IN STAGE OF ILLUMINATION, THE CREATION OF THE PLAY OF LIGHT ON THE WALLS PROJECTING FLOWERS AND DECORATIONS.







Lampade / lamps

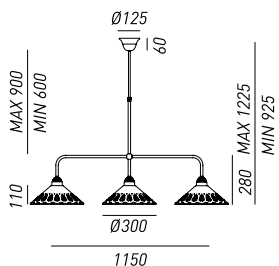

065.25.0C
3x Max 46W E27

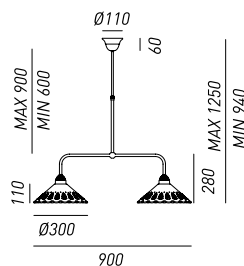

065.24.0C
2x Max 46W E27

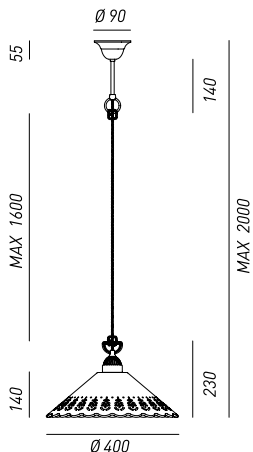

065.09.0C
1x Max 77W E27

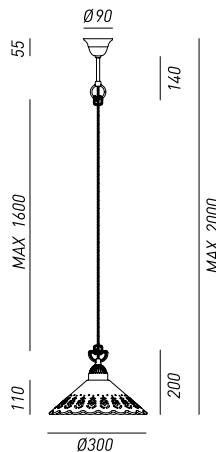

065.08.0C
1x Max 46W E27

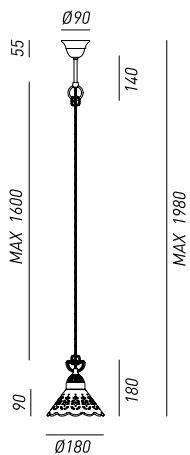

065.07.0C
1x Max 46W E27

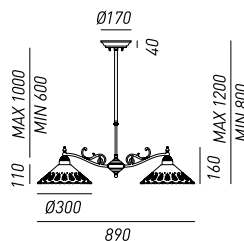

065.10.0C
2x Max 46W E27

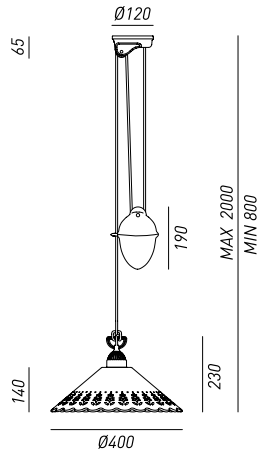

065.11.OC
1x Max 77W E27

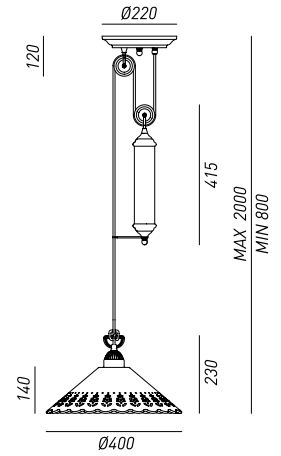

065.12.OC
1x Max 77W E27

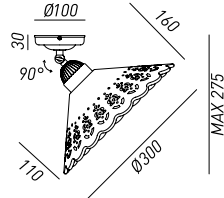

065.02.OC
1x Max 46W E27

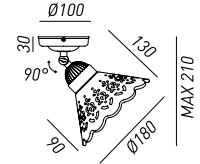

065.23.OC
1x Max 46W E27

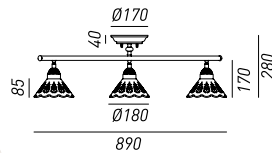

065.21.OC
3x Max 46W E27

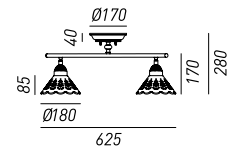

065.22.OC
2x Max 46W E27

lampade / lamps

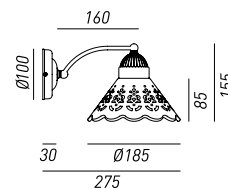
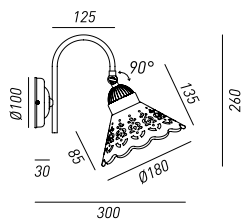

065.19.0C
1x Max 46W E27

065.17.0C
1x Max 46W E27

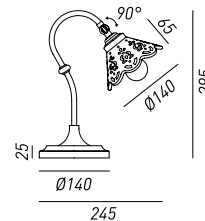
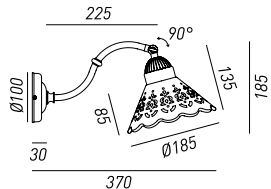

065.18.0C
1x Max 46W E27

065.52.0C
1x Max 46W E14

dettaglio rosoni / canopie's details



065.24-25
Ø 125 mm H 60 mm



065.10
Ø 170 mm H 40 mm



065.07-08-09
 Ø 90 mm H 55 mm



065.11
 Ø 120 mm H 65 mm



065.12
 Ø 220 mm H 120 mm

finiture montatura / frame finishes



OTTONE
 BRASS



CERAMICA
 CERAMIC

finiture testa / shade finishes



CERAMICA
 CERAMIC

ANITA



L'ECCELLENTE EQUILIBRIO TRA ELEGANZA DELLO STILE LIBERTY E MODERNO COMFORT FA DI QUESTA COLLEZIONE UN CAPOLAVORO DI MAESTRIA ARTIGIANALE, CONTRADDISTINTA DA DETTAGLI SAPIENTEMENTE RICERCATI. LE FAMOSE CERAMICHE DI BASSANO CON CUI SONO REALIZZATE LE LAMPADE ANITA, CONFERISCONO VALORE AGGIUNTO A QUESTE CREAZIONI.

THE OUTSTANDING BALANCE OF ELEGANCE IN THE ART NOUVEAU STYLE AND MODERN COMFORT MAKE THIS COLLECTION A MASTERPIECE OF CRAFTSMANSHIP, CHARACTERIZED BY EXPERTLY RESEARCHED DETAILS. THE FAMOUS CERAMICS OF BASSANO USED TO MAKE THESE LAMPS, ADD ADDITIONAL VALUE TO THESE CREATIONS.









lampade / lamps

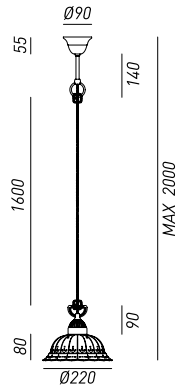

061.07.OC
1x Max 46W E27

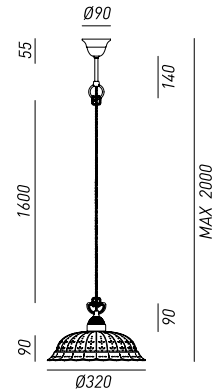

061.08.OC
1x Max 46W E27

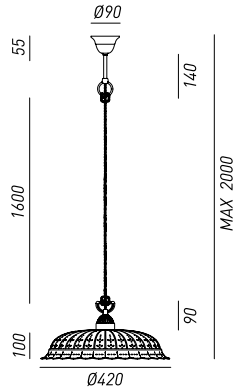

061.09.OC
1x Max 77W E27

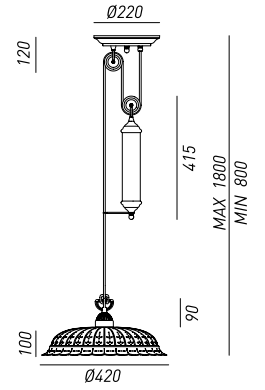

061.12.OC
1x Max 77W E27

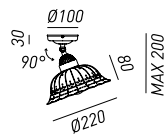

061.23.OC
1x Max 46W E27

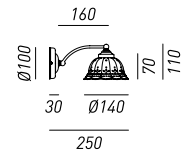

061.17.OC
1x Max 46W E14

Lampade / lamps

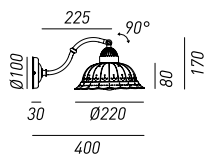

061.18.0C
1x Max 46W E27

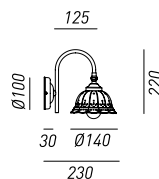

061.19.0C
1x Max 46W E14

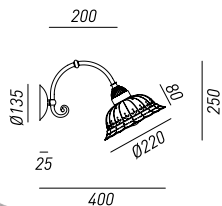

061.37.0C
1x Max 46W E27

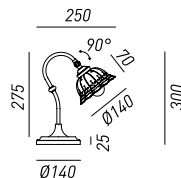

061.52.0C
1x Max 46W E14

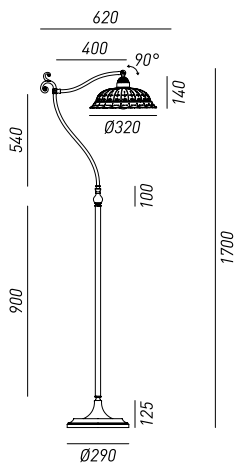

061.53.0C
1x Max 77W E27

dettaglio rosoni / canopie's details



061.12
Ø 220 mm H 120 mm



061.07-08-09
Ø 90 mm H 55 mm

finiture montatura / frame finishes



OTTONE
BRASS

finiture testa / shade finishes



CERAMICA
CERAMIC

TABIÀ





REALIZZATE IN VETRO E MONTATURE
IN OTTONE ANTICATO, QUESTE
LAMPADRE RAPPRESENTANO LA
PIÙ ALTA ESPRESSIONE DELLO
STILE NEW CLASSIC. L'INTERA
COLLEZIONE SEGNA L'ATTENTA
RICERCA DELLA SEMPLIFICAZIONE
E DEL MINIMALISMO STILISTICO
RIVISITANDO IN CHIAVE MODERNA
MATERIALI TIPICI DELLA TRADIZIONE
ITALIANA.

MADE OF GLASS AND FRAMES IN
ANTIQUÉ BRASS, THESE LAMPS
ARE THE HIGHEST EXPRESSION OF
NEW CLASSIC STYLE. THE ENTIRE
COLLECTION MARKS THE CAREFUL
RESEARCH OF SIMPLICITY AND
STYLISTIC MINIMALISM REVISITING IN
MODERN MATERIALS TYPICAL OF THE
ITALIAN TRADITION.







lampade / lamps

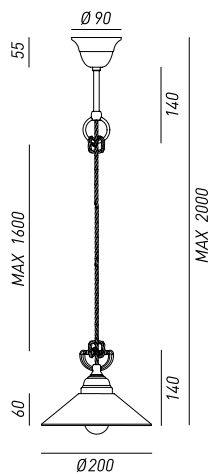

212.07.OV
1x Max 46W E14

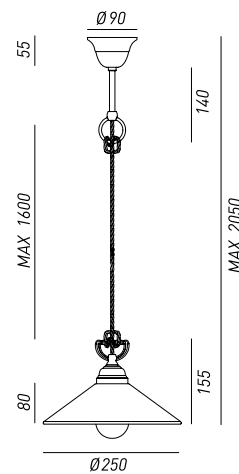

212.08.OV
1x Max 77W E27

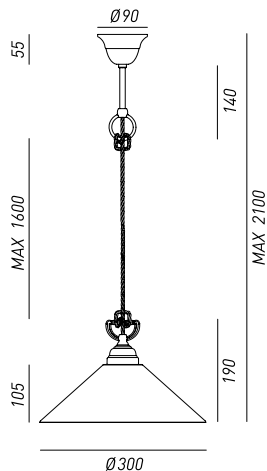

212.09.OV
1x Max 77W E27

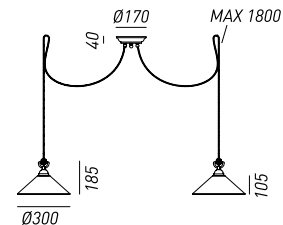

212.10.OV
2x Max 77W E27

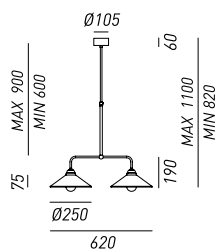

212.24.OV
2x Max 77W E27

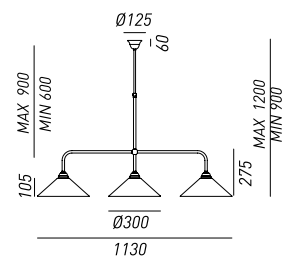

212.25.OV
3x Max 77W E27

lampade / lamps

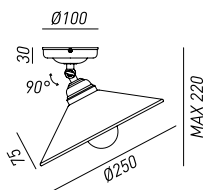

212.02.OV
1x Max 77W E27

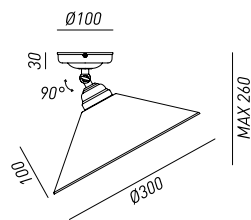

212.03.OV
1x Max 77W E27

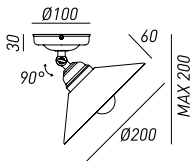

212.23.OV
1x Max 46W E14

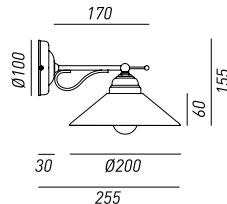

212.14.OV
1x Max 46W E14

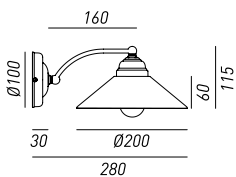

212.17.OV
1x Max 46W E14

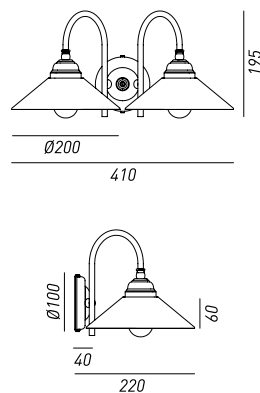

212.20.OV
2x Max 46W E14

dettaglio rosoni / canopie's details



212.10
Ø 170 mm H 40 mm



212.07-08-09
Ø 90 mm H 55 mm



212.25-24
Ø 110 mm H 60 mm

finiture montatura / frame finishes



OTTONE
BRASS

finiture testa / shade finishes



VETRO
GLASS

CONTRADA





IL PURISMO STILISTICO
CONTRASSEGNA LA COLLEZIONE
CONTRADA: LAMPADE DAL DESIGN
RIGOROSO ED ESSENZIALE
REALIZZATE IN RAME E OTTONE
ANTICATO. IL MATERIALE, RICERCATO
E DI GRANDE QUALITÀ, CONFERISCE
A QUESTI PRODOTTI UN GRANDE
IMPATTO MATERICO.

THE STYLISTIC PURISM MARKS THE
CONTRADA COLLECTION: LAMPS
WITH RIGOROUS AND ESSENTIAL
DESIGN MADE OF COPPER AND
ANTIQUÉ BRASS. THE SOPHISTICATED
AND OF HIGH QUALITY MATERIAL,
GIVES THESE PRODUCTS A GREAT
MATERIAL IMPACT.





Lampade / lamps

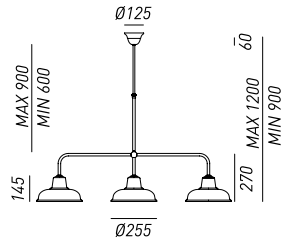



211.11.OR
3x Max 77W E27 



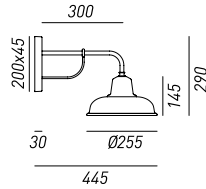

243.02.OR
1x Max 77W E27 
IP 20



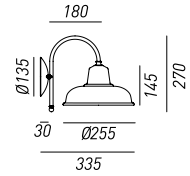



243.05.OR
1x Max 77W E27 
IP 23 

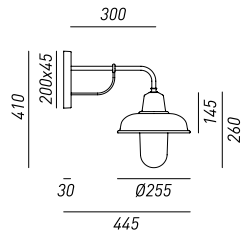





243.06.OR
1x Max 77W E27 
IP 23 

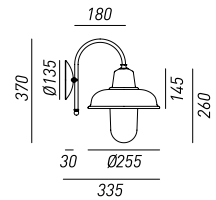

243.25.ORB
243.25.ORT
1x Max 57W E27 
1x Max 23W E27  
IP 44 



243.26.ORB
243.26.ORT
1x Max 57W E27 
1x Max 23W E27  
IP 44 

dettaglio rosoni / canopie's details



211.11
Ø 110 mm H 60 mm



243.07
Ø 110 mm H 60 mm

finiture montatura / frame finishes



OTTONE
BRASS

finiture testa / shade finishes



RAME
COPPER

vetro / glass



VETRO BIANCO
WHITE GLASS



VETRO TRASPARENTE
TRANSPARENT GLASS

BARCHESSA





IL DESIGN MINIMALISTA E CONCETTUALE DELLE LAMPADE DELLA COLLEZIONE BARCHESSA, REALIZZATE IN FERRO, OTTONE O RAME ANTICATO, RISALTA IL MASSIMO DELLA LORO FUNZIONALITÀ. LE FORME PULITE E LIBERE DA QUALSIASI ARTIFICIOSITÀ SIMBOLEGGIANO IN MANIERA ESCLUSIVA QUESTI PRODOTTI, VISIBILMENTE ISPIRATI ALL'ARTE POVERA.

THE MINIMALIST AND CONCEPTUAL DESIGN OF THE BARCHESSA LAMPS' COLLECTION MADE OF IRON, BRASS OR COPPER, BRINGS OUT THE MOST OF THEIR FUNCTIONALITY. CLEAN AND ARTIFICIALITY-FREE SHAPES SYMBOLIZE THE EXCLUSIVITY OF THESE PRODUCTS, VISIBLY INSPIRED BY POOR ART.











lampade / lamps

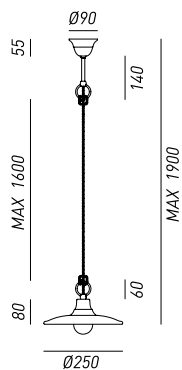

220.10.00
220.10.OR
1x Max 57W E27

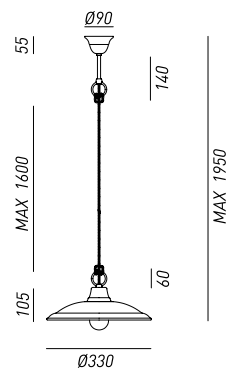

220.11.OR
1x Max 77W E27

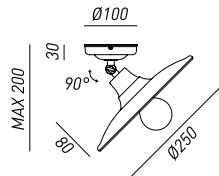

220.02.00
220.02.OR
1x Max 57W E27

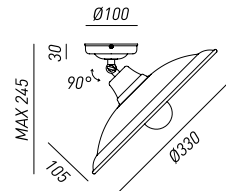

220.03.OR
1x Max 77W E27

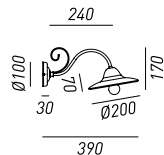

220.04.OR
220.04.FO
1x Max 46W E14

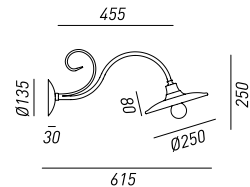

220.05.OR
220.05.FO
1x Max 77W E27



220.06.ORB
1x Max 77W E27



220.07.ORB
220.07.ORT
1x Max 57W E27
1x Max 23W E27
IP 44

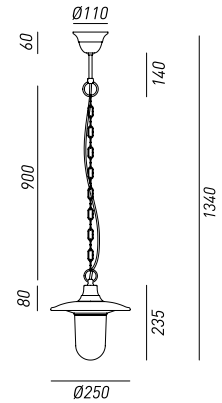

220.08.ORB
220.08.ORT
1x Max 57W E27
1x Max 23W E27
IP 44

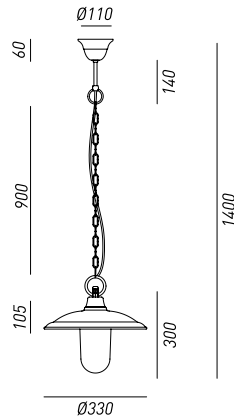

220.12.ORB
220.12.ORT
1x Max 57W E27
1x Max 23W E27
IP 44

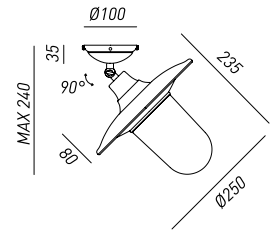

220.13.ORB
220.13.ORT
1x Max 75 W E27
1x Max 23W E27
IP 44

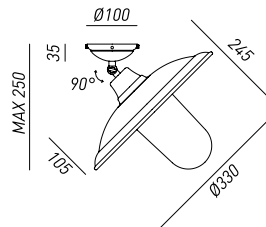

220.25.ORB
220.25.ORT
1x Max 57W E27
1x Max 23W E27
IP 44

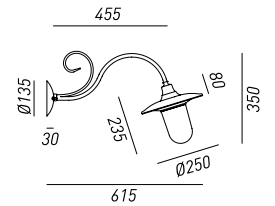

lampade / lamps



220.26.ORB
220.26.ORT
 1x Max 57W E27
 1x Max 23W E27
 IP 44

pali / lamp posts

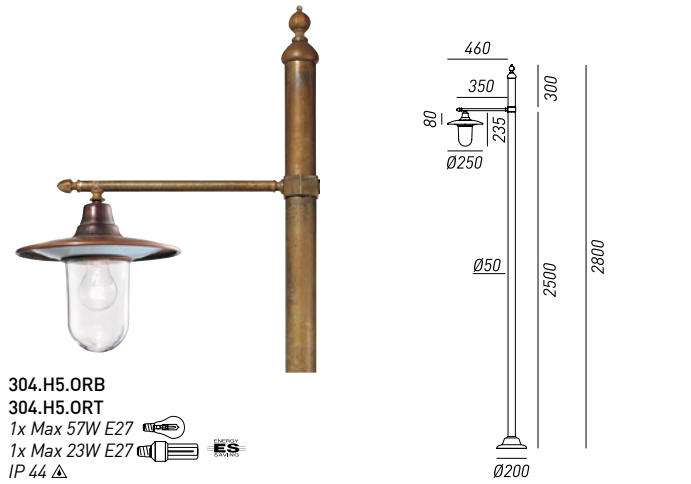

304.H5.ORB
304.H5.ORT
 1x Max 57W E27
 1x Max 23W E27
 IP 44

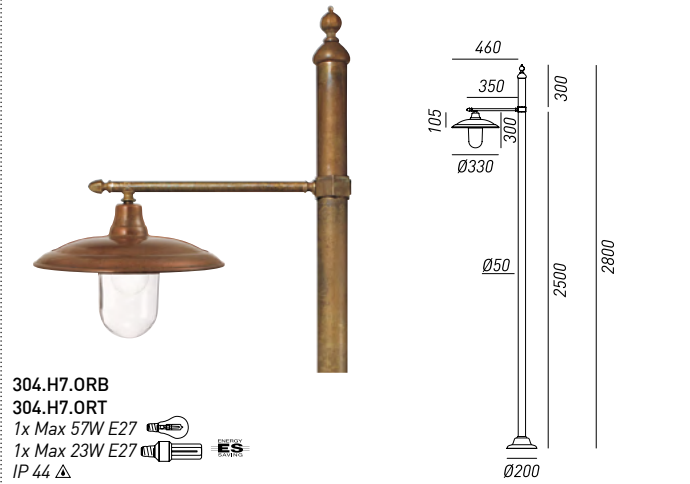

304.H7.ORB
304.H7.ORT
 1x Max 57W E27
 1x Max 23W E27
 IP 44

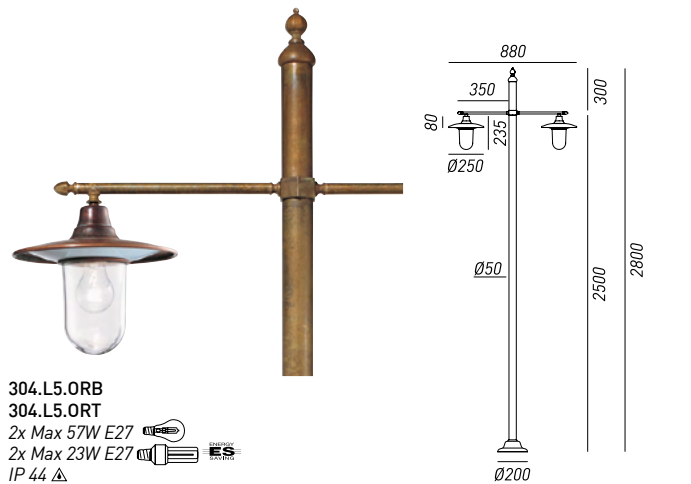



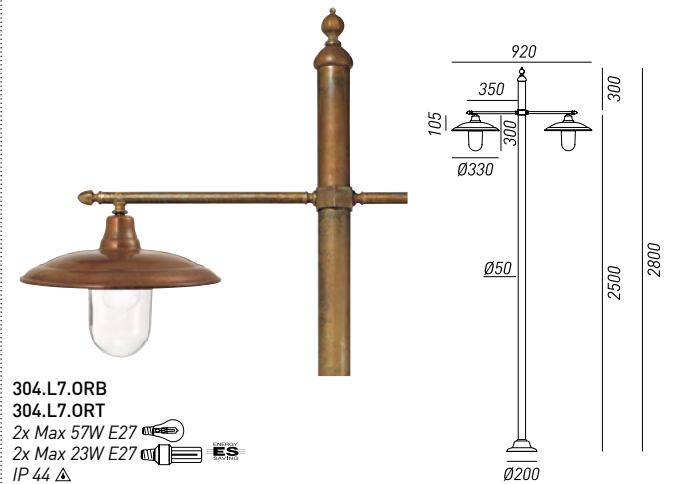

304.L5.ORB
304.L5.ORT
 2x Max 57W E27
 2x Max 23W E27
 IP 44

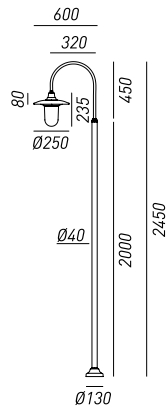





304.L7.ORB
304.L7.ORT
 2x Max 57W E27
 2x Max 23W E27
 IP 44

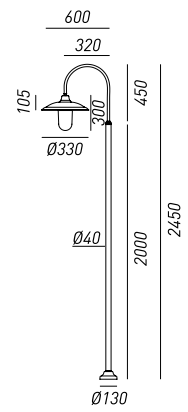

301.D5.ORB
301.D5.ORT
1x Max 57W E27 
1x Max 23W E27  
IP 44 



301.D7.ORB
301.D7.ORT
1x Max 57W E27 
1x Max 23W E27  
IP 44 

dettaglio rosoni / canopie's details



220.07-08
Ø 110 mm H 60 mm



220.10-11
Ø 90 mm H 55 mm

finiture montatura / frame finishes



OTTONE
BRASS

finiture testa / shade finishes



OTTONE
BRASS

vetro / glass



VETRO BIANCO
WHITE GLASS



VETRO TRASPARENTE
TRANSPARENT GLASS

DROP





ISPIRATE ALLE LUCI DELLE SAGRE PAESANE, LE LAMPADE DELLA COLLEZIONE DROP RAPPRESENTANO UNA SOLUZIONE ORIGINALE PER L'ARREDAMENTO DEGLI AMBIENTI ESTERNI E INTERNI. TRASPARENZA E SEMPLICITÀ CONTRADDISTINGUONO QUESTE LAMPADE REALIZZATE IN OTTONE, RAME E VETRO, REINTERPRETAZIONE IN CHIAVE CONTEMPORANEA DELLA TRADIZIONALE FORMA A GOCCIA. PUNTI LUCE DAL DESIGN RICERCATO CHE ILLUMINANO GLI SPAZI CON ELEGANTE DISCREZIONE AMALGAMANDOSI CON IL PAESAGGIO.

INSPIRED BY TOWN FESTIVAL LIGHTS, THE DROP COLLECTION REPRESENT A UNIQUE SOLUTION FOR OUTDOOR AND INDOOR ENVIRONMENTS. THANKS TO THEIR TRANSPARENCY AND SIMPLICITY, THESE LAMPS MADE OF BRASS, COPPER AND GLASS GIVE A NEW CONTEMPORARY REINTERPRETATION OF THE TEARDROP FORM. THE LIGHT ILLUMINATES SPACES WITH ELEGANT DISCRETION THAT DISSOLVES INTO THE LANDSCAPE.









MENU

AVANA	-ARANCIA	-MELONE
ENZERO	-MELA	-CAROTA
MPELMO	-FRAGOLA	-FINOCCHIO
GURIA	-CILIEGIA	-LIME
BICOCCA	-PESCA	-MIRTILLO
MONTE	-KIWI	-BANANA
CCO	-MANGO	-PAPAIA

carbonato
180 gr.
2 uova
250 ml

Mirtilli freschi
Sale impiccico
2 uova
Vanillina

...ndendo il form... a 180. Fate ammorbidire
...o a temperatura ambiente e poi sbatte
...mer, caramelle, assieme allo zucchero
...alcune minuti, fino a che il composto risulta
...so. Rompete le uova in una ciotola e unitele
...la volta e lentamente, sempre sbattendo.









SISTEMA COMPOSTO DA / SYSTEM MADE OF:

Codici / Codes: 1 X 270.06.00
1 X 270.38.AA
1 X 270.37.10
4 X 270.10.00
3 X 270.02.ORT



lampade / lamps

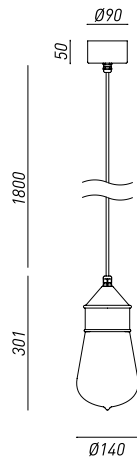

270.03.ORT
1x Max 57W E27
IP55

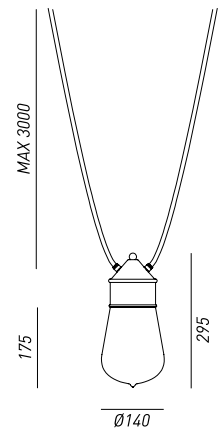

270.02.ORT
1x Max 57W E27
IP55

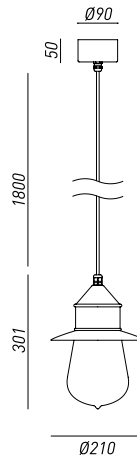

270.13.ORT
1x Max 57W E27
IP55

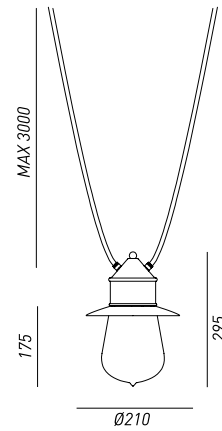

270.12.ORT
1x Max 57W E27
IP55

dettaglio rosone / canopie's details



270.01-11
Ø 90 mm H 50 mm

accessori / accessories

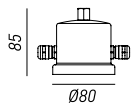

270.10.00
 Ø 80 mm H 85 mm
 Scatola di connessione per cavo d'acciaio.
 Connection box for steel cable.
 IP 44 ▲

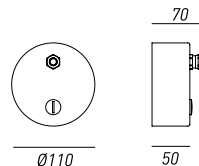

270.06.00
 Ø 110 mm H 50 mm
 Rosone da muro o soffitto con due stringicavo piu un tappo.
 Wall or ceiling canopy with two cable glands and screw top.
 IP 44 ▲

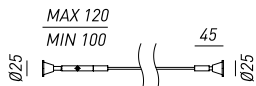

270.08.AA
 Kit per cavo d'acciaio Ø 3 mm.
 Kit for steel cable Ø 3 mm.

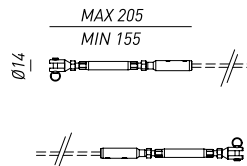

270.38.AA
 Kit per cavo d'acciaio, Ø 4 mm
 Kit for steel cable, Ø 4 mm

270.07.05
 Cavo d'acciaio Ø 3 mm, 5 m.
 Steel cable Ø 3 mm, 5 m.

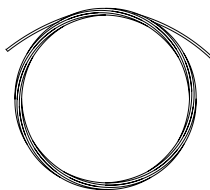

270.37.10
 Cavo d'acciaio Ø 4 mm, 10 m
 Steel cable Ø 4 mm, 10 m
270.37.20
 Cavo d'acciaio Ø 4 mm, 20 m
 Steel cable Ø 4 mm, 20 m
270.37.30
 Cavo d'acciaio Ø 4 mm, 30 m
 Steel cable Ø 4 mm, 30 m

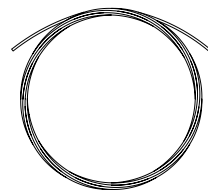

finiture montatura / frame finishes



OTTONE
BRASS

finiture testa / shade finishes



OTTONE
BRASS



RAME
COPPER

vetro / glass



VETRO TRASPARENTE
TRANSPARENT GLASS

**ATTENZIONE!!**

FINO A 3 LAMPADE E CON TRATTE INFERIORI O UGUALI AI 5 METRI UTILIZZARE GLI ARTICOLI:

- 270.07.05 (CAVO ACCIAIO Ø 3 mm, 5 m)
- 270.08.AA (KIT CAVO ACCIAIO Ø 3 mm)

WARNING!!

UP TO 3 LAMPS AND WITH CABLE SECTIONS LOWER OR UGUAL THAN 5 METERS, YOU HAVE TO USE THE FOLLOWING ITEMS:

- 270.07.05 (Ø 3 mm STEEL CABLE 5 m)
- 270.08.AA (KIT FOR STEEL CABLE Ø 3 mm)

**ATTENZIONE!!**

PIÙ DI 3 LAMPADE O CON TRATTE SUPERIORI AI 5 METRI UTILIZZARE GLI ARTICOLI:

- 270.37.10/20/30 (CAVO ACCIAIO Ø 4 mm, 10 m / 20 m / 30 m)
- 270.38.AA (KIT CAVO ACCIAIO Ø 4 mm)

WARNING!!

FOR MORE THAN 3 LAMPS OR WITH CABLE SECTIONS LONGER THAN 5 METERS, YOU HAVE TO USE THE FOLLOWING ITEMS:

- 270.37.10/20/30 (Ø 4 mm STEEL CABLE, 10 m / 20 m / 30 m)
- 270.38.AA (KIT FOR STEEL CABLE Ø 4 mm)

LANTERNE



LA LUCE TENUE E AMBRATA DIVENTA ASSOLUTA PROTAGONISTA DI QUESTA SERIE DI LAMPADE DI CHIARA ISPIRAZIONE ORIENTALEGGIANTE. I PRODOTTI DELLA COLLEZIONE LANTERNE, CON MONTATURE IN OTTONE O FERRO E VETRO TRASPARENTE, REINTERPRETANO IN CHIAVE CONTEMPORANEA TUTTO IL FASCINO DELLA TIPICA ATMOSFERA A LUME DI CANDELA.

THE SOFT AND AMBER LIGHT BECOMES AN ABSOLUTE PROTAGONIST OF THESE SERIES OF LAMPS CLEARLY INSPIRED BY ORIENTAL FEATURES. THE PRODUCTS OF LANTERNE COLLECTION, WITH FRAMES MADE OF BRASS OR IRON AND TRANSPARENT GLASS, REINTERPRET IN A CONTEMPORARY LIGHT ALL THE CHARM OF THE TYPICAL ATMOSPHERE OF CANDLELIGHT.













lampade / lamps

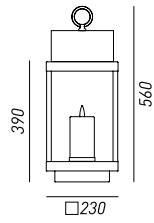

265.01.00
265.01.FF
1x Max 28W E27
1x Max 12W E27
IP 65

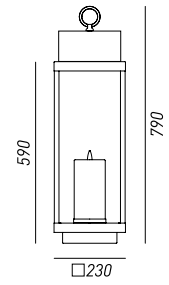

265.02.00
265.02.FF
1x Max 42W E27
1x Max 20W E27
IP 65

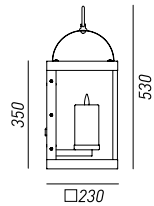

265.03.00
265.03.FF
1x Max 28W E27
1x Max 12W E27
IP 65

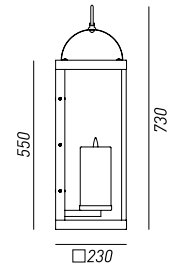

265.04.00
265.04.FF
1x Max 42W E27
1x Max 20W E27
IP 65

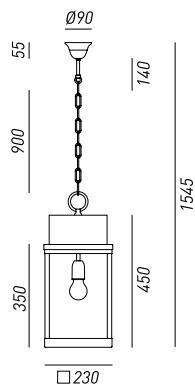

265.07.00
265.07.FF
1x Max 70W E27
IP 44

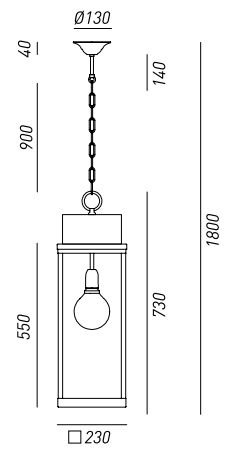

265.08.00
265.08.FF
1x Max 105W E27
IP 44

Lampade / lamps

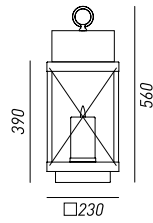

265.11.00
265.11.FF
1x Max 28W E27
1x Max 12W E27
IP 65

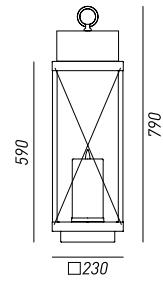

265.12.00
265.12.FF
1x Max 42W E27
1x Max 20W E27
IP 65

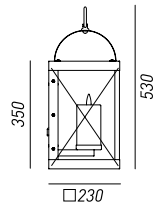

265.13.00
265.13.FF
1x Max 28W E27
1x Max 12W E27
IP 65

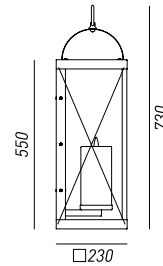

265.14.00
265.14.FF
1x Max 42W E27
1x Max 20W E27
IP 65

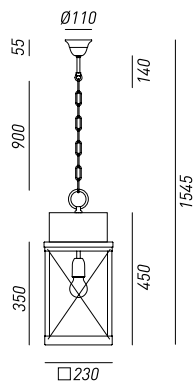

265.17.00
265.17.FF
1x Max 70W E27
IP 44

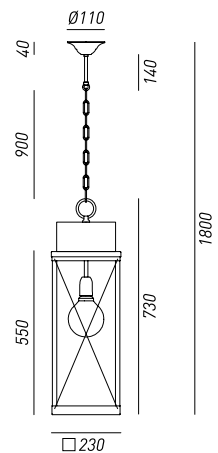

265.18.00
265.18.FF
1x Max 105W E27
IP 44

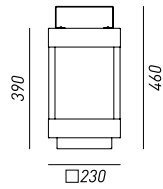

266.01.00
266.01.FF
1x 18W 2G10
IP 65

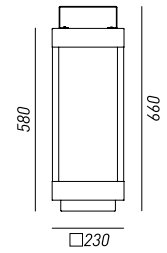

266.02.00
266.02.FF
1x 18W 2G10
IP 65

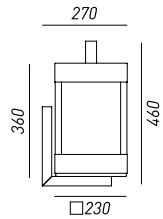

266.03.00
266.03.FF
1x 18W 2G10
IP 65

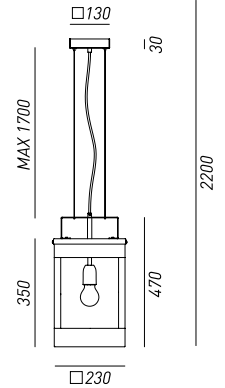

266.07.00
266.07.FF
1x Max 70W E27
IP 44

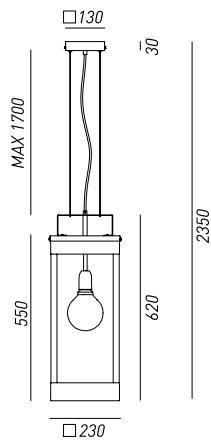

266.08.00
266.08.FF
1x Max 105W E27
IP 44

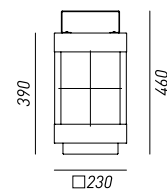

266.11.00
266.11.FF
1x 18W 2G10
IP 65

Lampade / lamps

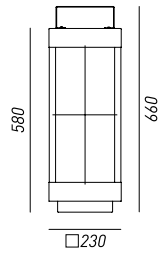

266.12.00
266.12.FF
1x 18W 2G10
IP 65

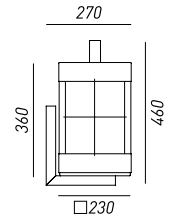

266.13.00
266.13.FF
1x 18W 2G10
IP 65

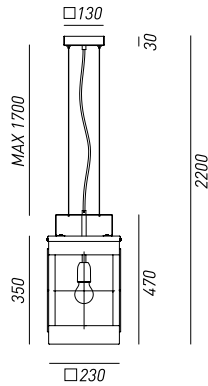

266.17.00
266.17.FF
1x Max 70W E27
IP 44

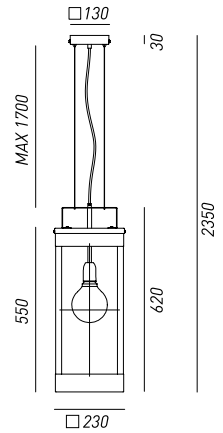

266.18.00
266.18.FF
1x Max 105W E27
IP 44

optional



PICCHETTO / STAKE
266.30.FZ
□ 140 mm H 400 mm

dettaglio rosoni / canopie's details



265.08-18
Ø 110 mm H 40 mm



266.07-08-17-18
Ø 130 mm H 30 mm

finiture montatura / frame finishes



OTTONE
BRASS

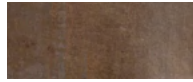

FERRO
IRON

vetro / glass



VETRO TRASPARENTE
TRANSPARENT GLASS

QUADRO



CREATA SU MISURA PER UNA DELLE PIÙ SUGGESTIVE REALIZZAZIONI DE IL FANALE, LA COLLEZIONE QUADRO È ENTRATA POI A FAR PARTE DEL CATALOGO. L'ELEGANZA ASSOLUTA, LE FORME GEOMETRICHE INCONTAMINATE E I RIFERIMENTI IRLANDESI CARATTERIZZANO QUESTE LAMPADE PRODOTTE IN VETRO TRASPARENTE O PLEXIGLASS BIANCO E OTTONE ANTICATO.

THIS STRIKING COLLECTION STARTED OUT AS A SPECIAL MADE-TO-ORDER RANGE OF LAMPS, BUT IT IS NOW PART OF OUR CATALOGUE. THESE LAMPS, WHICH ARE ABSOLUTELY ELEGANT IN THEIR PRISTINE GEOMETRIC SHAPES, ARE MADE WITH BRASS FRAMES AND EITHER TRANSPARENT GLASS OR WHITE PLEXIGLASS.









Lampade / lamps

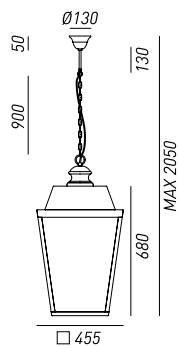

262.50.OB
262.50.OT
1x Max 116W E27
IP 43

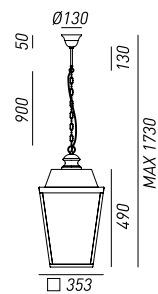

262.51.OB
262.51.OT
1x Max 77W E27
IP 43

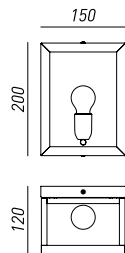

262.01.OT
1x Max 30W E14
IP 55

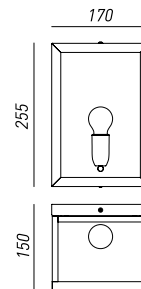

262.02.OT
1x Max 46W E27
IP 55

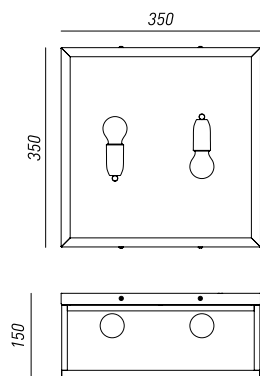

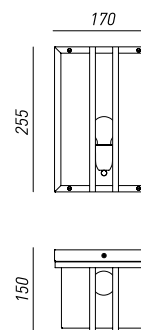

262.03.OT
2x Max 30W E27
IP 55

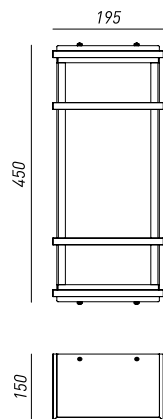

262.07.OT
1x Max 46W E27
IP 55

(vedi realizzazione pag. 464) / (see project on page 464)



262.10.0B
 1x Max 42W GX 24q 3/4 
 Ballast included
 IP 55 

dettaglio rosoni / canopie's details



262.50-51
 Ø 130 mm H 55 mm

finiture montatura / frame finishes



OTTONE
BRASS

vetro / glass



VETRO TRASPARENTE
TRANSPARENT GLASS



PLEXIGLASS BIANCO
WHITE PLEXIGLASS

DECORI



NATA DALLA FORTE ESIGENZA DI ESALTARE UN'ILLUMINAZIONE PROPRIAMENTE TECNICA, LA COLLEZIONE DECORI VALORIZZA L'ATTENTA RICERCA MATERICA. LE LAMPADE, DISPONIBILI IN FERRO O RAME, SONO CARATTERIZZATE DA UN'ESTREMA ESSENZIALITÀ DELLE LINEE GARANTENDO COMUNQUE UNA PERFETTA COESIONE TRA FUNZIONALITÀ E LATO ESTETICO.

CREATED FROM THE GREAT NEED FOR ENHANCEMENT OF PROPER ILLUMINATION TECHNIQUE, DECORI COLLECTION ENHANCES THE CAREFUL MATERIAL RESEARCH. THE LAMPS, AVAILABLE IN IRON OR COPPER, ARE CHARACTERIZED BY AN EXTREME SIMPLICITY OF THE LINES WHILE STILL PROVIDING A PERFECT COHESION BETWEEN FUNCTIONALITY AND AESTHETICS.















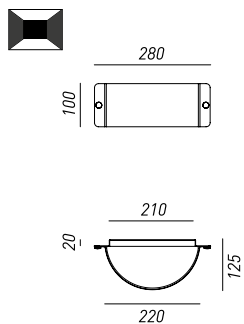

lampade / lamps



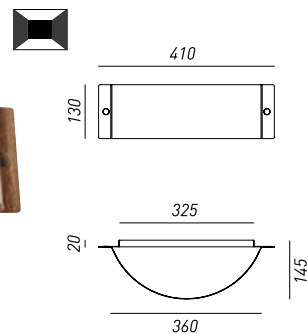

252.01.RR
252.01.RF
1x Max 46W E27 
252.51.RR
252.51.RF
LED 8,5W 3000K
IP 54 



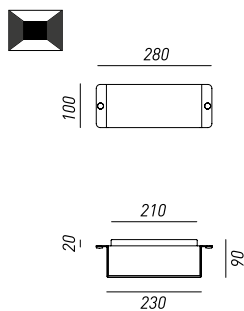

252.02.RR
252.02.RF
2x Max 30W E27 
252.52.RR
252.52.RF
LED 13W 3000K
IP 54 



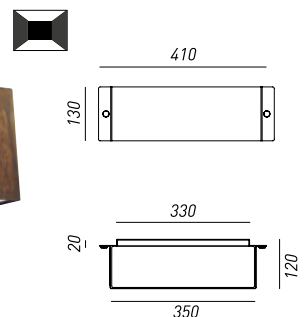

252.03.RR
252.03.RF
1x Max 46W E27 
252.53.RR
252.53.RF
LED 8,5W 3000K
IP 54 



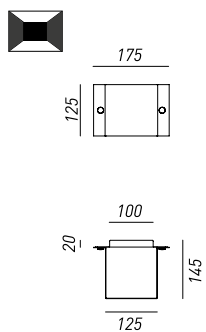

252.04.RR
252.04.RF
2x Max 30W E27 
252.54.RR
252.54.RF
LED 13W 3000K
IP 54 



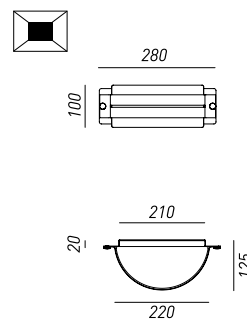

252.05.RR
252.05.RF
1x Max 33W G9 
252.55.RR
252.55.RF
LED 7,5W 3000K
IP 54 



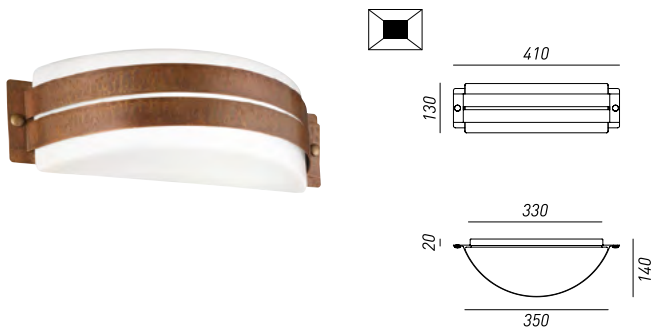

252.06.RR
252.06.RF
1x Max 46W E27 
252.56.RR
252.56.RF
LED 8,5W 3000K
IP 54 





252.07.RR
252.07.RF
2x Max 30W E27 
252.57.RR
252.57.RF
LED 13W 3000K
IP 54 



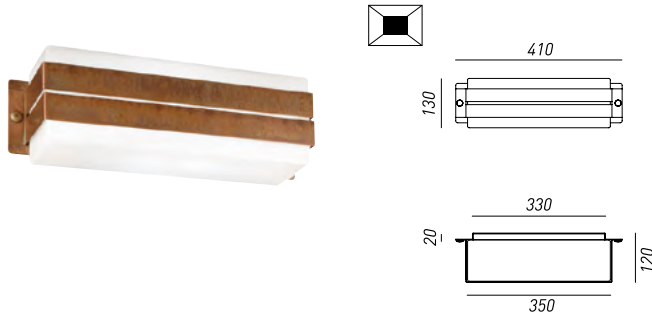

252.08.RR
252.08.RF
1x Max 46W E27 
252.58.RR
252.58.RF
LED 8,5W 3000K
IP 54 



252.09.RR 
252.09.RF
2x Max 30W E27
252.59.RR
252.59.RF
LED 13W 3000K
IP 54 

legenda simboli / symbols key

 LUCE BIDIREZIONALE
BIDIRECTIONAL LIGHT

 LUCE DIFFUSA
DIFFUSED LIGHT

finiture fascia / band finishes

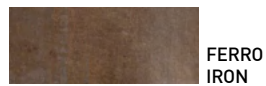

vetro / glass



BORGO





ARTIGIANALITÀ E ATTENTA RICERCA DEI MATERIALI SI FONDONO CON LE PIÙ RECENTI TECNICHE D'ILLUMINAZIONE DANDO VITA ALLA COLLEZIONE BORG0 CHE SI CONFIGURA COME LA PIÙ ALTA RAPPRESENTAZIONE DEL MOOD AZIENDALE. LE LAMPADE, REALIZZATE IN RAME ED OTTONE, PRESENTANO FORME D'ISPIRAZIONE CLASSICA SAPIENTEMENTE RIVISITATE IN CHIAVE CONTEMPORANEA.

CRAFTMANSHIP AND CAREFUL RESEARCH OF THE MATERIALS, COMBINED WITH THE LATEST ILLUMINATION TECHNIQUES, MAKE THE BORG0 COLLECTION AS THE HIGHEST REPRESENTATION OF THE COMPANY'S MOOD. THE LAMPS, MADE OF COPPER AND BRASS, ARE FORMS OF CLASSICAL INSPIRATION WISELY REVISITED IN A CONTEMPORARY WAY.







lampade / lamps

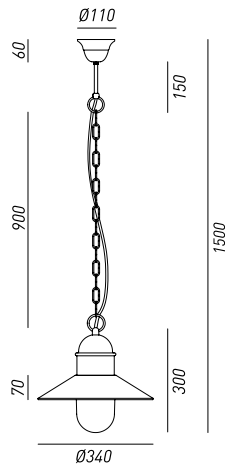

244.08.ORB
244.08.ORT
1x Max 116W E27
1x Max 30W E27
IP 44

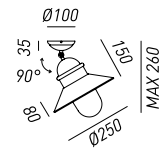

244.02.ORB
244.02.ORT
1x Max 57W E27
1x Max 23W E27
IP 43

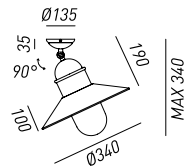

244.03.ORB
244.03.ORT
1x Max 116W E27
1x Max 30W E27
IP 43

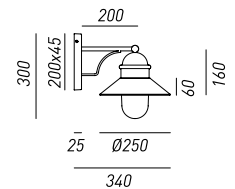

244.05.ORB
244.05.ORT
1x Max 57W E27
1x Max 23W E27
IP 44

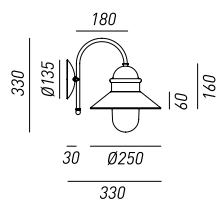

244.06.ORB
244.06.ORT
1x Max 57W E27
1x Max 23W E27
IP 44

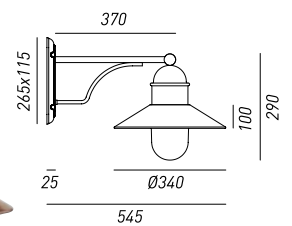

244.25.ORB
244.25.ORT
1x Max 116W E27
1x Max 30W E27
IP 44

pali / lamp posts

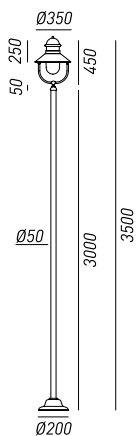

244.30.ORB
244.30.ORT
1x Max 116W E27
1x Max 30W E27
IP 44

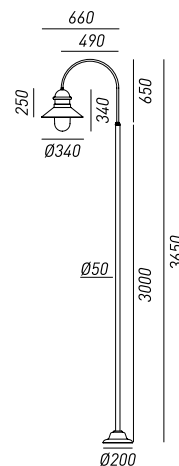

244.40.ORB
244.40.ORT
1x Max 116W E27
1x Max 30W E27
IP 44

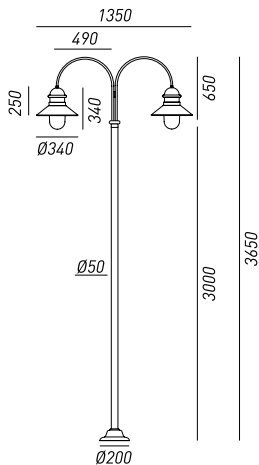

244.42.ORB
244.42.ORT
2x Max 116W E27
2x Max 30W E27
IP 44

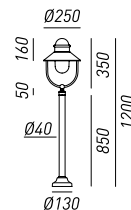

301.B2.ORB
301.B2.ORT
1x Max 57W E27
1x Max 23W E27
IP 44

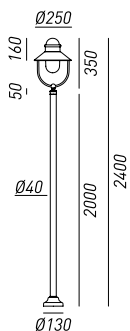

301.B4.ORB
301.B4.ORT
1x Max 57W E27
1x Max 23W E27
IP 44

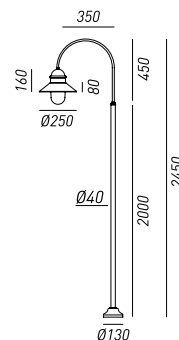

301.D3.ORB
301.D3.ORT
1x Max 57W E27
1x Max 23W E27
IP 44

pali / lamp posts

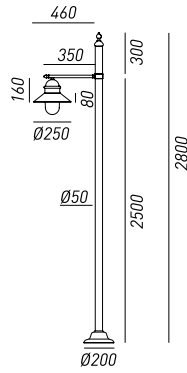

304.H3.ORB
 304.H3.ORT
 1x Max 57W E27
 1x Max 23W E27
 IP 44

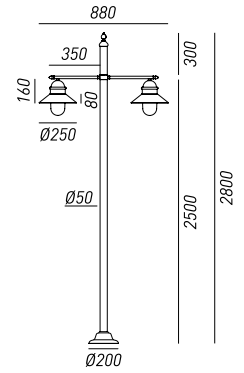

304.L3.ORB
 304.L3.ORT
 2x Max 57W E27
 2x Max 23W E27
 IP 44

dettaglio rosoni / canopie's details



244.08-09
 Ø 110 mm H 60 mm

finiture montatura / frame finishes



OTTONE
 BRASS

finiture testa / shade finishes



OTTONE
 BRASS



RAME
 COPPER

vetro / glass



VETRO BIANCO
 WHITE GLASS



VETRO TRASPARENTE
 TRANSPARENT GLASS

CALMAGGIORE



L'IMPATTO VISIVO DELICATO
MA DECISO CARATTERIZZA LE
LAMPADINE DI QUESTA COLLEZIONE,
DESTINATE AGLI AMBIENTI
OUTDOOR. I PRODOTTI, REALIZZATI
IN RAME E OTTONE ANTICATO, SONO
CONTRADDISTINTI DA UN'EFFICIENTE
EMISSIONE LUMINOSA CHE
CONFERISCE CARATTERE AGLI SPAZI
ARREDATI.

THIS OUTDOOR COLLECTION OF
LAMPS OFFERS A FIRM YET DELICATE
VISUAL IMPACT. THE LAMPS,
WHICH ARE MADE OF COPPER
AND ANTIQUED BRASS, GIVE OFF
EFFICIENT LIGHT WHILE ADDING
CHARACTER TO THE FURNISHED
SPACE.







lampade / lamps



233.03.ORB
233.03.ORT
1x Max 46W E27
1x Max 20W E27
IP 44

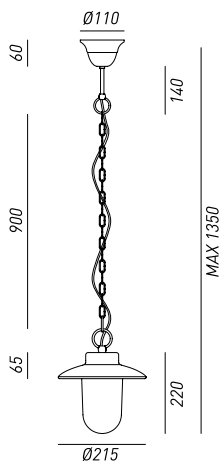

231.03.ORB
231.03.ORT
1x Max 46W E27
1x Max 20W E27
IP 44

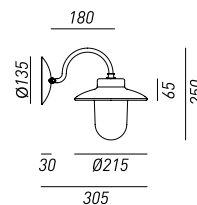

230.03.ORB
230.03.ORT
1x Max 46W E27
1x Max 20W E27
IP 44

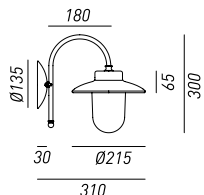

232.06.ORB
232.06.ORT
1x Max 46W E27
1x Max 20W E27
IP 43

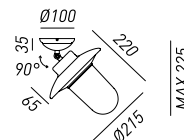

pali / lamp posts



304.H1.ORB
304.H1.ORT
1x Max 57W E27
1x Max 23W E27
IP 44

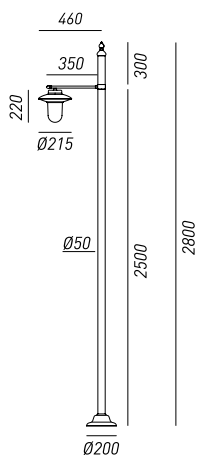

304.L1.ORB
304.L1.ORT
2x Max 57W E27
2x Max 23W E27
IP 44

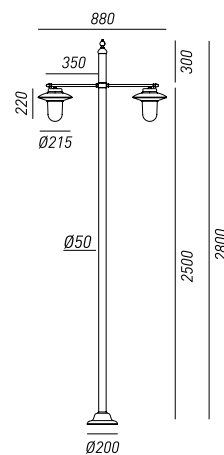

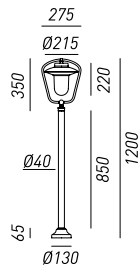

301.B3.ORB
 301.B3.ORT
 1x Max 57W E27
 1x Max 23W E27
 IP 44

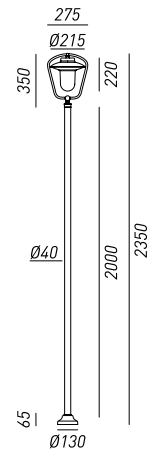

301.B5.ORB
 301.B5.ORT
 1x Max 57W E27
 1x Max 23W E27
 IP 44

dettaglio rosoni / canopie's details



233.03
 Ø 110 mm H 60 mm

finiture montatura / frame finishes



OTTONE
 BRASS

finiture testa / shade finishes



RAME
 COPPER

vetro / glass



VETRO BIANCO
 WHITE GLASS



VETRO TRASPARENTE
 TRANSPARENT GLASS

PATIO





LAMPADRE DA ESTERNO
CARATTERIZZATE DAL DESIGN SOBRIO
ED ESSENZIALE REALIZZATE IN
RAME E OTTONE ANTICATO. GRAZIE
ALL'ASPETTO E ALLA RICERCATA
LAVORAZIONE, I PRODOTTI DI QUESTA
COLLEZIONE SI CONFIGURANO COME
ELEMENTI DECORATIVI DALL'ALTA
FUNZIONALITÀ TECNICA.

THESE OUTDOOR LAMPS ARE
DISTINGUISHED BY A SIMPLE
DESIGN AND ARE MADE OF
COPPER AND ANTIQUED BRASS.
THANKS TO THEIR LOOK AND
REFINED MANUFACTURING, THESE
LAMPS STAND OUT AS HIGH-
TECH, FUNCTIONING DECORATIVE
ELEMENTS.







lampade / lamps

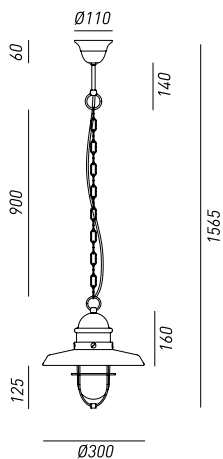

225.07.ORB
225.07.ORT
1x Max 57W E27
1x Max 23W E27
IP 44

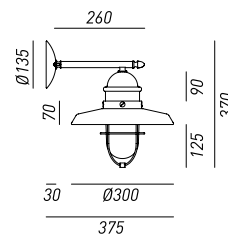

225.05.ORB
225.05.ORT
1x Max 57W E27
1x Max 23W E27
IP 44

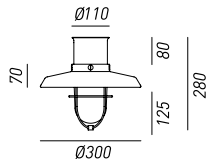

225.04.ORB
225.04.ORT
1x Max 57W E27
1x Max 23W E27
IP 43

dettaglio rosoni / canopies details



225.07
Ø 110 mm H 60 mm

finiture montatura / frame finishes



**OTTONE
BRASS**

finiture testa / shade finishes



**OTTONE
BRASS**



**RAME
COPPER**

vetro / glass



**VETRO BIANCO
WHITE GLASS**



**VETRO TRASPARENTE
TRANSPARENT GLASS**

GRANAIO



NATA DALLA FORTE ESIGENZA DI
ESALTARE UN'ILLUMINAZIONE
PROPRIAMENTE TECNICA, LA
COLLEZIONE DECORI VALORIZZA
L'ATTENTA RICERCA MATERICA. LE
LAMPADIE, DISPONIBILI IN OTTONE
E RAME, SONO CARATTERIZZATE DA
UN'ESTREMA ESSENZIALITÀ DELLE
LINEE GARANTENDO COMUNQUE
UNA PERFETTA COESIONE TRA
FUNZIONALITÀ E LATO ESTETICO.

CREATED FROM THE GREAT NEED
FOR ENHANCEMENT OF PROPER
ILLUMINATION TECHNIQUE, DECORI
COLLECTION ENHANCES THE
CAREFUL MATERIAL RESEARCH. THE
LAMPS, AVAILABLE IN BRASS AND
COPPER, ARE CHARACTERIZED BY AN
EXTREME SIMPLICITY OF THE LINES
WHILE STILL PROVIDING A PERFECT
COHESION BETWEEN FUNCTIONALITY
AND AESTHETICS.







lampade / lamps

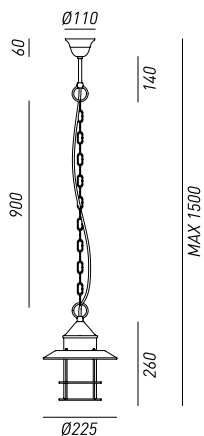

246.07.ORB
246.07.ORT
1x Max 57W E27
1x Max 23W E27
IP 44

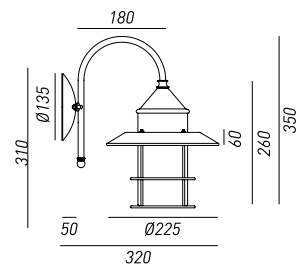

246.06.ORB
246.06.ORT
1x Max 57W E27
1x Max 23W E27
IP 44

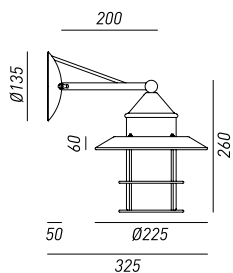

246.05.ORB
246.05.ORT
1x Max 57W E27
1x Max 23W E27
IP 44

pali / lamp posts

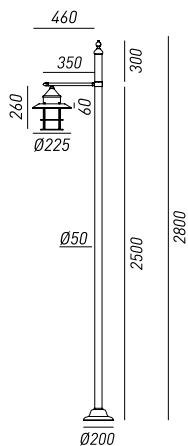

304.H8.ORB
304.H8.ORT
1x Max 57W E27
1x Max 23W E27
IP 44

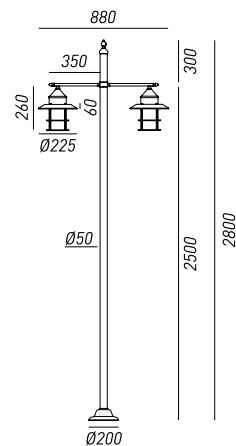

304.L8.ORB
304.L8.ORT
2x Max 57W E27
2x Max 23W E27
IP 44

dettaglio rosoni / canopie's details



246.07
 Ø 110 mm H 60 mm

finiture montatura / frame finishes



OTTONE
 BRASS

finiture testa / shade finishes



OTTONE
 BRASS



RAME
 COPPER

vetro / glass



VETRO BIANCO
 WHITE GLASS



VETRO TRASPARENTE
 CLEAR GLASS

FIORDO





LA COLLEZIONE FIORDO NASCE DALLA VOLONTÀ DI ADATTARE CARATTERISTICHE TIPICHE DEL DESIGN D'INTERNI A PRODOTTI DESTINATI ALL'OUTDOOR. LE LINEE ESTETICHE ISPIRATE AI PAESI SCANDINAVI, CONFERISCONO PERSONALITÀ A QUESTE LAMPADE, REALIZZATE IN OTTONE E RAME, CREANDO ATMOSFERE ACCOGLIENTI E FAMILIARI IN AMBIENTI ESTERNI.

THIS COLLECTION COMES FROM THE DESIRE TO ADAPT INTERIOR DESIGN PRODUCTS FEATURES IN OUTDOOR SURROUNDINGS ONES. THE AESTHETIC LINES INSPIRED BY THE SCANDINAVIAN COUNTRIES, GIVE PERSONALITY TO THESE LAMPS, MADE OF BRASS AND COPPER, CREATING A WELCOMING AND FAMILIAR ATMOSPHERE FOR THE OUTDOORS ENVIRONMENT.







lampade / lamps

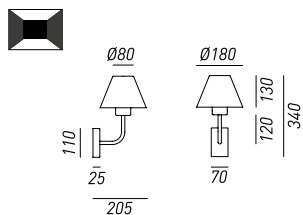

261.01.OR
1x Max 48W G9

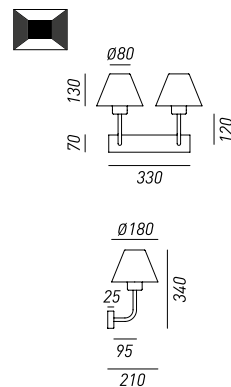

261.02.OR
2x Max 48W G9

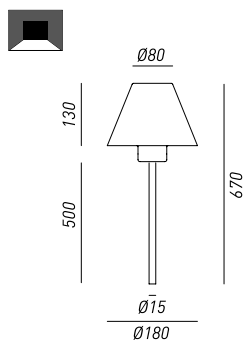

261.10.OR
1x Max 48W G9

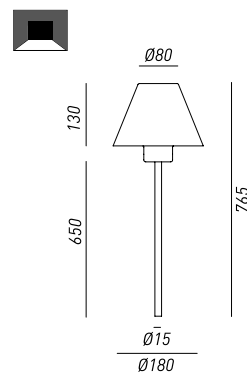

261.11.OR
1x Max 48W G9

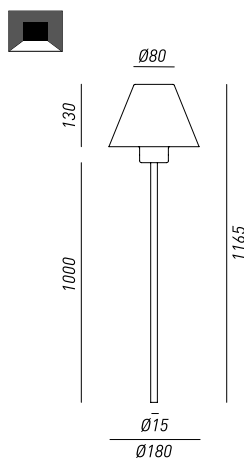
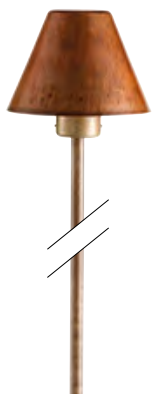

261.12.OR
1x Max 48W G9

legenda simboli / symbols key

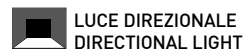
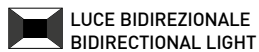

optional



PICCHETTO / STAKE
260.30.FZ
Ø 95 mm H 250 mm

finiture montatura / frame finishes



OTTONE
BRASS

finiture testa / shade finishes



RAME
COPPER

vetro / glass



VETRO BIANCO
WHITE GLASS

VENEZIA





UN TRIBUTO ALLA CITTÀ DI VENEZIA, DALLA QUALE QUESTA COLLEZIONE PRENDE IL NOME. GUSTO CLASSICO E DISEGNO ELEGANTE CARATTERIZZANO QUESTE LAMPADE DA ESTERNI REALIZZATE IN OTTONE, RAME ANTICATO E VETRO BIANCO O PULEGOSO, TECNICA, QUEST'ULTIMA, CHE CONFERISCE NOTEVOLI EFFETTI CROMATICI.

THIS COLLECTION IS NAMED AS A TRIBUTE TO THE CITY OF VENICE. THESE OUTDOOR LAMPS ARE CLASSICALLY AND ELEGANTLY DESIGNED AND MADE OF BRASS, ANTIQUED COPPER WITH EITHER WHITE OR "PULEGOSO" GLASS TECHNIQUE, THE LATTER GIVING OFF PECULIAR CHROMATIC EFFECTS.













lampade / lamps

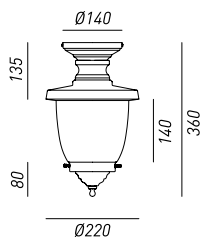

248.02.ORB
248.02.ORT
1x Max 57W E27
1x Max 23W E27
IP 44

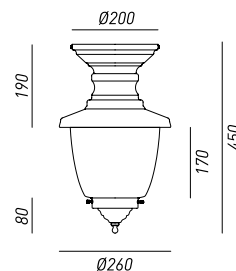

248.03.ORB
248.03.ORT
1x Max 57W E27
1x Max 30W E27
IP 44

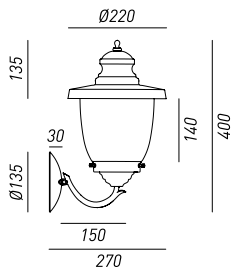

248.05.ORB
248.05.ORT
1x Max 57W E27
1x Max 23W E27
IP 44

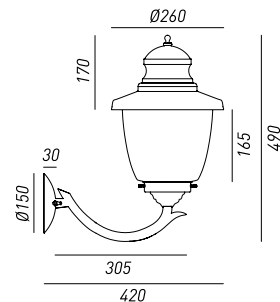

248.06.ORB
248.06.ORT
1x Max 57W E27
1x Max 30W E27
IP 44

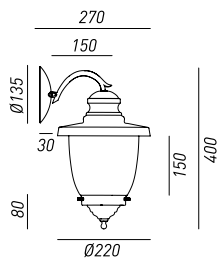

248.09.ORB
248.09.ORT
1x Max 57W E27
1x Max 23W E27
IP 44

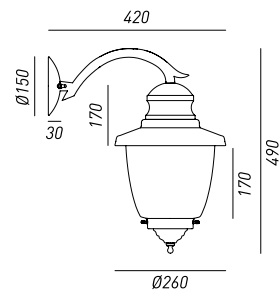

248.10.ORB
248.10.ORT
1x Max 57W E27
1x Max 30W E27
IP 44

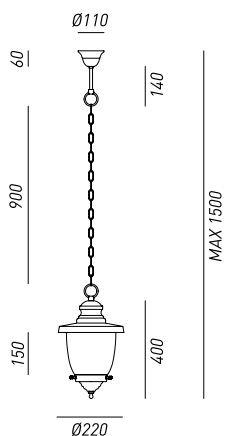

248.07.ORB
248.07.ORT
1x Max 57W E27
1x Max 23W E27
IP 44

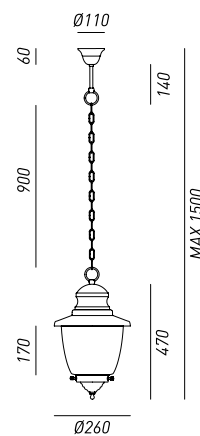

248.08.ORB
248.08.ORT
1x Max 57W E27
1x Max 30W E27
IP 44

pali / lamp posts

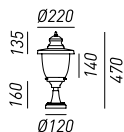

248.11.ORB
248.11.ORT
1x Max 57W E27
1x Max 23W E27
IP 44

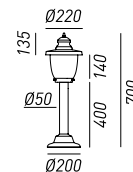

248.12.ORB
248.12.ORT
1x Max 57W E27
1x Max 23W E27
IP 44

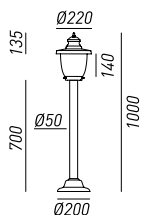

248.13.ORB
248.13.ORT
1x Max 57W E27
1x Max 23W E27
IP 44

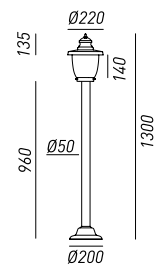

248.14.ORB
248.14.ORT
1x Max 57W E27
1x Max 23W E27
IP 44

pali / lamp posts

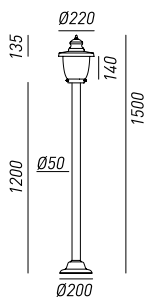
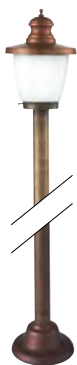

248.15.ORB
248.15.ORT
1x Max 57W E27
1x Max 23W E27
IP 44

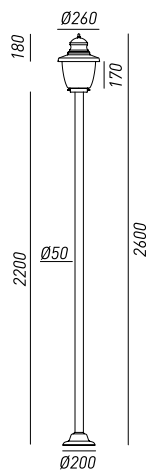

248.18.ORB
248.18.ORT
1x Max 77W E27
1x Max 30W E27
IP 44

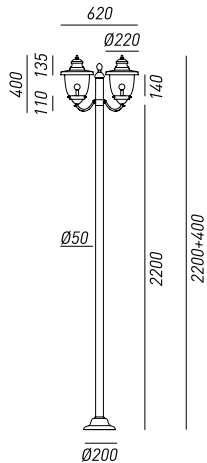

248.20.ORB
248.20.ORT
2x Max 57W E27
2x Max 23W E27
IP 44

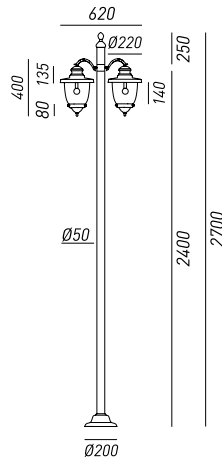

248.27.ORB
248.27.ORT
2x Max 57W E27
2x Max 23W E27
IP 44

dettaglio rosone / canopie's details



248.07-08
Ø 110 mm H 60 mm

finiture montatura / frame finishes



OTTONE
BRASS

finiture testa / shade finishes



RAME
COPPER

vetro / glass



VETRO BIANCO
WHITE GLASS



VETRO PULEGOSO
BUBBLE GLASS

LOGGIA



LAMPADE DALLA FORMA
CILINDRICA EVOCANO SUGGESTIVE
ATMOSFERE ATTRAVERSO
UNA REINTERPRETAZIONE IN
CHIAVE MODERNA DEI CLASSICI
PORTACANDELE A MURO.
REALIZZATA IN VETRO BIANCO O
PULEGOSO E OTTONE ANTICATO
LA COLLEZIONE È COMPOSTA DA
APPLIQUE, SOSPENSIONI E LAMPADE
DA TERRA.

THESE CYLINDRICAL SHAPED LAMPS
ARE A MODERN INTERPRETATION
OF THE CLASSIC WALL MOUNTED
CANDLESTICK. MADE IN ANTIQUED
BRASS WITH EITHER WHITE OR
"PULEGOSO" GLASS TECHNIQUE,
THIS COLLECTION INCLUDES WALL
MOUNTED, SUSPENSION AND FLOOR
LAMPS.







Lampade / lamps

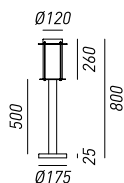

264.10.00T
264.10.00B
1x Max 46W E27
1x Max 20W E27
IP 44

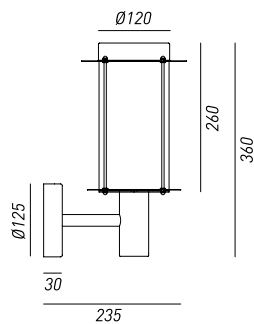

264.01.00T
264.01.00B
1x Max 46W E27
1x Max 20W E27
IP 44

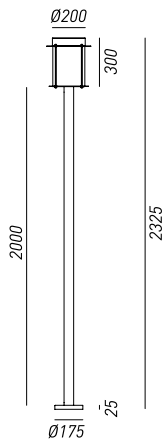
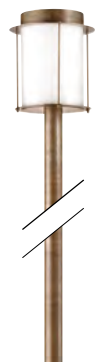

264.14.00T
264.14.00B
1x Max 57W E27
1x Max 30W E27
IP 44

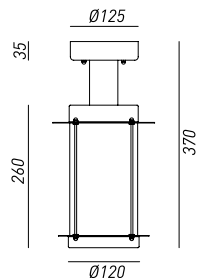

264.02.00T
264.02.00B
1x Max 46W E27
1x Max 20W E27
IP 44

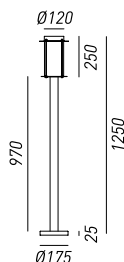

264.11.00T
264.11.00B
1x Max 46W E27
1x Max 20W E27
IP 44

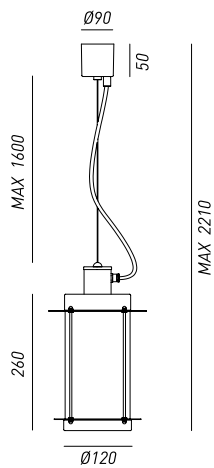

264.07.00T
264.07.00B
1x Max 46W E27
1x Max 20W E27
IP 44

dettaglio rosoni / canopie's details



244.07
L 90 mm H 50 mm

finiture montatura / frame finishes



OTTONE
BRASS

finiture testa / shade finishes



OTTONE
BRASS

vetro / glass



VETRO BIANCO
WHITE GLASS



VETRO PULEGOSO
BUBBLE GLASS

GARDEN









COLLEZIONE DAL DESIGN
ESSENZIALE E CONTEMPORANEO
REALIZZATA IN OTTONE E RAME
ANTICATO. GRAZIE ALLE SUE
CARATTERISTICHE ESTETICHE E
FUNZIONALI QUESTE LAMPADE
ARREDANO GLI AMBIENTI ESTERNI
OTTENENDO UN IMPATTO VISIVO
SOBRIO ED ELEGANTE.

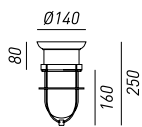



THIS SIMPLY DESIGNED AND
CONTEMPORARY COLLECTION IS
MADE OF BRASS AND ANTIQUED
COPPER. THANKS TO ITS
FUNCTIONAL AND APPEALING
FEATURES, THE GARDEN
COLLECTION IS ABLE TO DECORATE
THE OUTSIDE SETTING GIVING OFF
A MODEST AND ELEGANT VISUAL
IMPACT.

Lampade / lamps

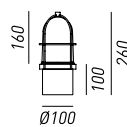





245.50.ORB
245.50.ORT
1x Max 57W E27 
1x Max 23W E27  
IP 43

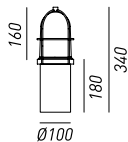





245.51.ORB
245.51.ORT
1x Max 57W E27 
1x Max 23W E27  
IP 44 

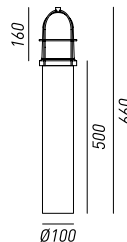





245.52.ORB
245.52.ORT
1x Max 57W E27 
1x Max 23W E27  
IP 44 

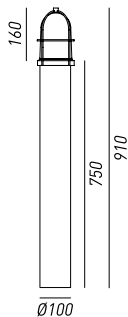





245.53.ORB
245.53.ORT
1x Max 57W E27 
1x Max 23W E27  
IP 44 

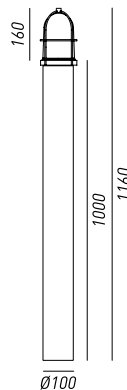





245.54.ORB
245.54.ORT
1x Max 57W E27 
1x Max 23W E27  
IP 44 

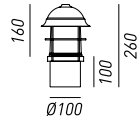





245.55.ORB
245.55.ORT
1x Max 57W E27 
1x Max 23W E27  
IP 44 

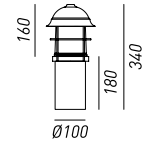





245.41.ORB
245.41.ORT
1x Max 57W E27 
1x Max 23W E27  
IP 44 

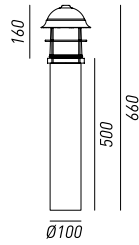





245.42.ORB
245.42.ORT
1x Max 57W E27 
1x Max 23W E27  
IP 44 

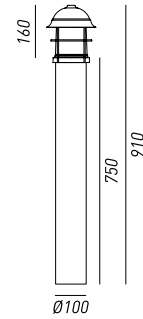





245.43.ORB
245.43.ORT
1x Max 57W E27 
1x Max 23W E27  
IP 44 

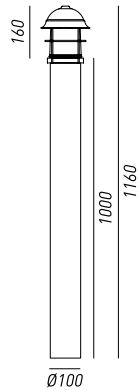



245.44.ORB
245.44.ORT
1x Max 57W E27 
1x Max 23W E27  
IP 44 

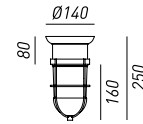

245.45.ORB
245.45.ORT
1x Max 57W E27 
1x Max 23W E27  
IP 44 



245.20.ORB
245.20.ORT
1x Max 57W E27 
1x Max 23W E27  
IP 43

Lampade / lamps

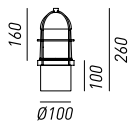

245.21.ORB
245.21.ORT
1x Max 57W E27
1x Max 23W E27
IP 44

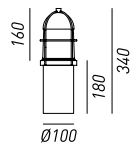

245.22.ORB
245.22.ORT
1x Max 57W E27
1x Max 23W E27
IP 44

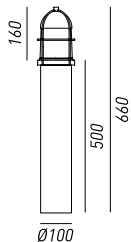

245.23.ORB
245.23.ORT
1x Max 57W E27
1x Max 23W E27
IP 44

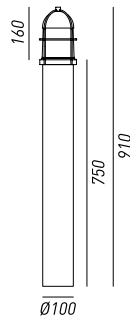

245.24.ORB
245.24.ORT
1x Max 57W E27
1x Max 23W E27
IP 44

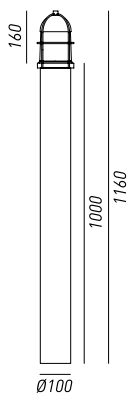

245.25.ORB
245.25.ORT
1x Max 57W E27
1x Max 23W E27
IP 44

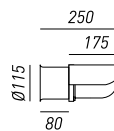

245.07.ORB
245.07.ORT
1x Max 46W E27
1x Max 23W E27
IP 44

optional



PICCHETTO / STAKE
300.09.FZ
Ø 110 H 400 mm



COPRIBASE / BASE COVER
300.06.RR
Ø 140 H 30 mm

finiture montatura / frame finishes



OTTONE
BRASS

finiture testa / shade finishes



OTTONE
BRASS



RAME
COPPER

vetro / glass



VETRO BIANCO
WHITE GLASS



VETRO TRASPARENTE
TRANSPARENT GLASS

PORTO



LA LUCE SOFFUSA MA DECISA
E IL DISEGNO MODERNO
CARATTERIZZANO LA COLLEZIONE
PORTO. L'ATTENTA LAVORAZIONE
ASSICURA UN ELEVATO STANDARD
QUALITATIVO A QUESTE LAMPADE DA
ESTERNO IN GRADO DI CONIUGARE
PERFETTAMENTE FUNZIONALITÀ ED
ESTETICA.

PORTO IS CHARACTERIZED BY A
SOFT BUT FIRM LIGHT, AS WELL AS
A MODERN DESIGN. THE CAREFUL
WORKMANSHIP ENSURES A HIGH
STANDARD OF QUALITY FOR
THESE OUTDOOR LAMPS, WHICH
PERFECTLY COMBINE BEAUTY AND
FUNCTIONALITY.







lampade / lamps

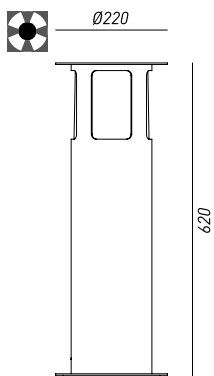

258.02.FF
 1x Max 57W E27
 1x Max 22W E27
 258.22.FF
 POWER LED 8,7W 3000K
 IP 65

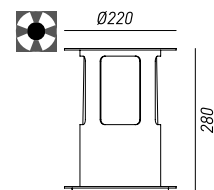

258.01.FF
 1x Max 57W E27
 1x Max 22W E27
 258.21.FF
 POWER LED 8,7W 3000K
 IP 65

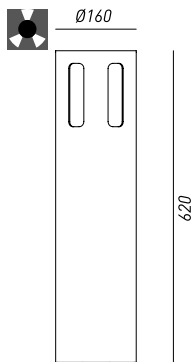

259.02.FF
 1x Max 57W E27
 1x Max 22W E27
 259.22.FF
 POWER LED 8,7W 3000K
 IP 65

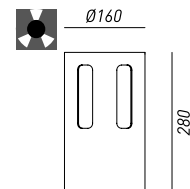

259.01.FF
 1x Max 57W E27
 1x Max 22W E27
 259.21.FF
 POWER LED 8,7W 3000K
 IP 65

legenda simboli / symbols key

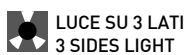
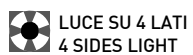

finiture montatura / frame finishes



vetro / glass



MARINA





NATA DALLA VOLONTÀ DI SODDISFARE ESIGENZE PROPRIAMENTE TECNICHE, QUESTA COLLEZIONE SI COMPONE DI LAMPADE DALL'ASPETTO EQUILIBRATO REALIZZATE IN OTTONE ANTICATO. IL DESIGN EVIDENTEMENTE ISPIRATO ALLO STILE MARINA, RAPPRESENTA IL LEITMOTIV CHE CARATTERIZZA OGNI SINGOLA REALIZZAZIONE.

THE DESIRE TO MEET PURELY TECHNICAL NEEDS STANDS BEHIND THIS COLLECTION OF LAMPS, MADE OF ANTIQUED BRASS. THEIR BALANCED DESIGN IS CLEARLY INSPIRED BY THE MARINA STYLE, WHOSE MOTIFS ARE REPRESENTED IN EVERY SINGLE PIECE.

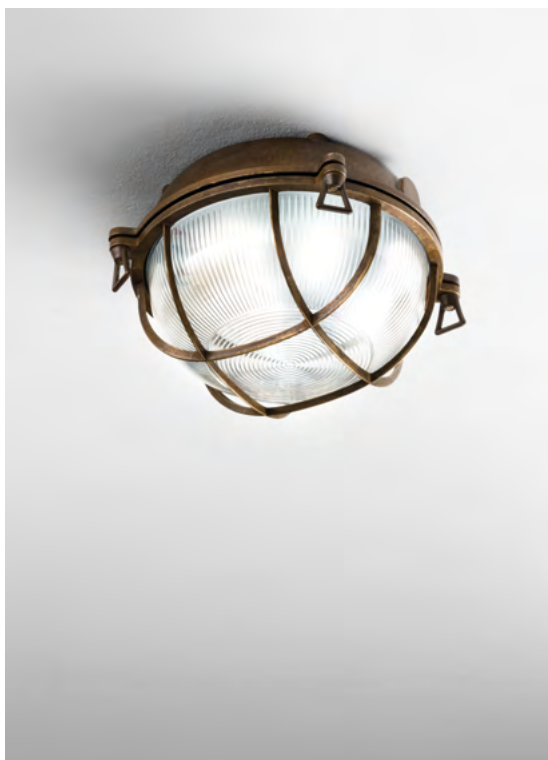





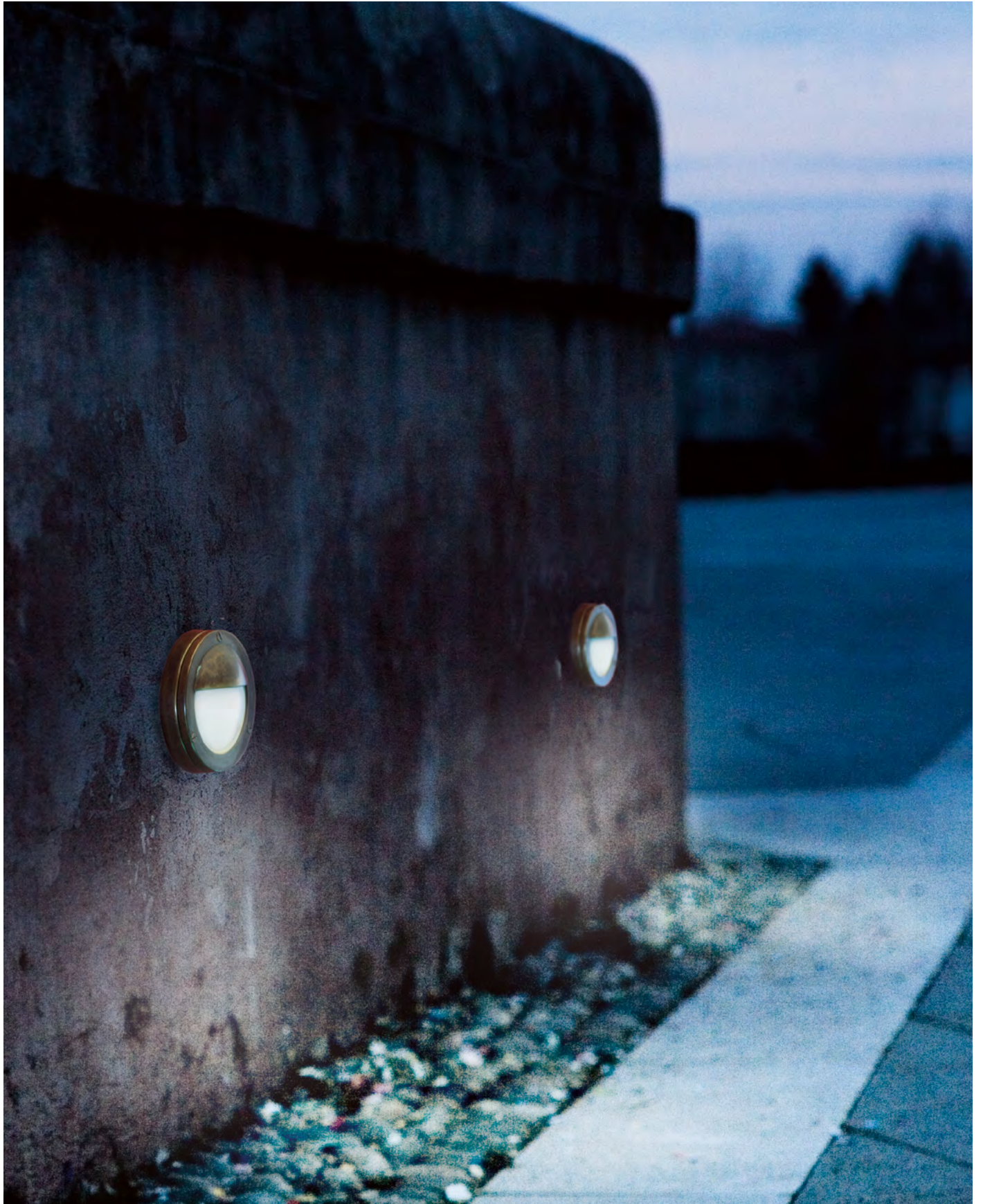

lampade / lamps

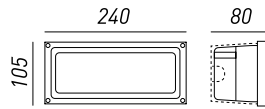

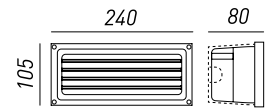

247.44.A0
LED 13W 3000K
247.25.A0
1x Max 46W E27 
IP 65 



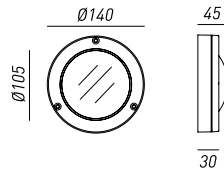

247.45.A0
LED 13W 3000K
247.26.A0
1x Max 30W E27 
IP 65 



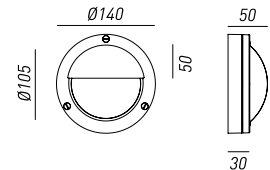

247.31.00
LED 7W 3000K
247.01.00
1x Max 25W G9 
247.21.00
1x Max 6W Gx53  POLYCARBONATE
IP 55 



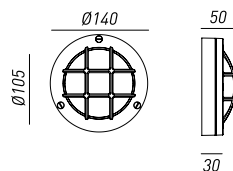

247.32.00
LED 7W 3000K
247.02.00
1x Max 25W G9 
247.22.00
1x Max 6W Gx53  POLYCARBONATE
IP 55 

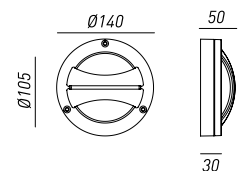

247.33.00
LED 7W 3000K
247.03.00
1x Max 25W G9 
247.23.00
1x Max 6W Gx53  POLYCARBONATE
IP 55 



247.34.00
LED 7W 3000K
247.04.00
1x Max 25W G9 
247.24.00
1x Max 6W Gx53  POLYCARBONATE
IP 55 

Lampade / lamps

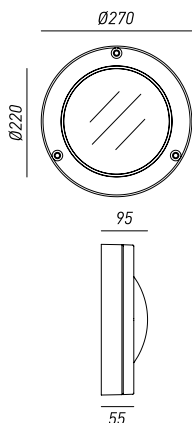

247.61.00
POLYCARBONATE
LED 13W 3000K
IP 55 ▲ ▲

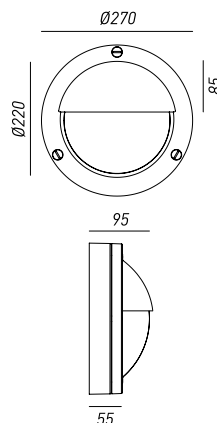

247.62.00
POLYCARBONATE
LED 13W 3000K
IP 55 ▲ ▲

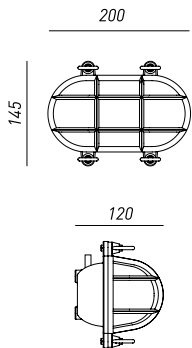

247.46.00
LED 8,7W 3000K
247.36.00
1x Max 46W E27
1x Max 11W E27
IP 54 ▲

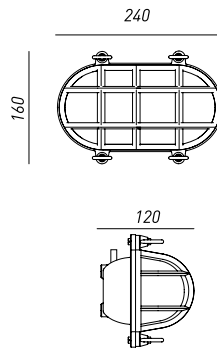

247.47.00
LED 13W 3000K
247.37.00
1x Max 77W E27
1x Max 23W E27
IP 54 ▲

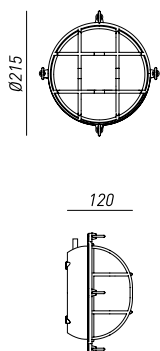

247.48.00
LED 8,7W 3000K
247.38.00
1x Max 57W E27
1x Max 15W E27
IP 54 ▲

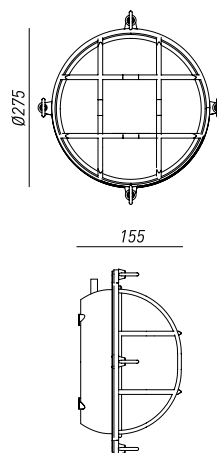

247.49.00
LED 13W 3000K
247.39.00
1x Max 77W E27
1x Max 23W E27
IP 54 ▲

finiture montatura / frame finishes



FUSIONE OTTONE
BRASS

vetro / glass

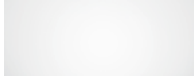

POLICARBONATO
POLYCARBONATE



VETRO
GLASS

PONTE





CARATTERIZZATE DALLA PRESENZA DI DUE PUNTI DI CONNESSIONE, QUESTE LAMPADE SONO IN GRADO DI RICREARE SUGGESTIVE ATMOSFERE RETRÒ GRAZIE ALLA FORZA VISIVA CHE LE CONTRADDISTINGUE. REALIZZATA IN OTTONE E RAME LA COLLEZIONE PONTE È CONCEPITA PER SODDISFARE ESIGENZE DI NATURA FUNZIONALE SENZA RINUNCIARE AL VALORE ESTETICO.

WITH THEIR TWO CONNECTING POINTS, THESE LAMPS RECREATE A SUGGESTIVE RETRO ATMOSPHERE THANKS TO THEIR VISUAL POWER. THE PONTE COLLECTION, MADE OF BRASS AND COPPER, IS DESIGNED TO SATISFY THE NEED FOR NATURAL FUNCTIONALITY WITHOUT SACRIFICING AESTHETICS.





Lampade / lamps

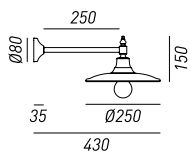

250.04.OR
1x Max 77W E27
IP 23

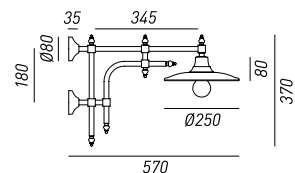
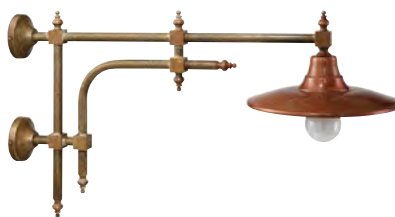

250.07.OR
1x Max 77W E27
IP 23

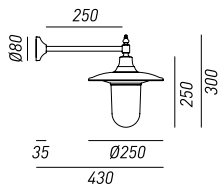

250.24.ORT
250.24.ORB
1x Max 57W E27
1x Max 23W E27
IP 44

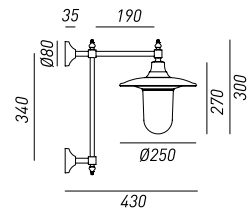

250.26.ORT
250.26.ORB
1x Max 57W E27
1x Max 23W E27
IP 44

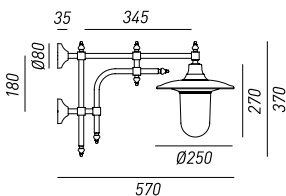

250.27.ORT
250.27.ORB
1x Max 57W E27
1x Max 23W E27
IP 44

finiture montatura / frame finishes



OTTONE
BRASS

finiture testa / shade finishes



RAME
COPPER

vetro / glass



VETRO BIANCO
WHITE GLASS



VETRO TRASPARENTE
TRANSPARENT GLASS

SISTEMA CANALINE





LA MAESTRIA ARTIGIANA UNITA
ALL'ESTREMA PERSONALIZZAZIONE
TROVANO NEL SISTEMA CANALINE
LA LORO MASSIMA ESPRESSIONE:
LA MODULARITÀ TIPICA DI QUESTO
SISTEMA, DISPONIBILE IN OTTONE
E OTTONE NATURALE OFFRE
MOLTEPLICI SOLUZIONI PER
L'ILLUMINAZIONE DEGLI AMBIENTI.

CRAFTSMANSHIP AND
CUSTOMIZATION ARE EMBODIED IN
SISTEMA CANALINE: THIS LIGHTING
SYSTEM, AVAILABLE BOTH IN BRASS
AND NATURAL BRASS, THANKS TO
ITS MODULARITY ALLOWS PLENTY OF
LIGHTING SOLUTIONS.









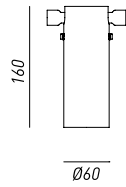

Lampade / lamps



214.04.FF
214.04.ON
214.04.OO
1x Max 35W GU10 

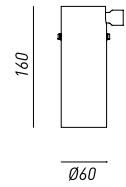

214.14.FF
214.14.ON
214.14.OO
1x Max 35W GU10 

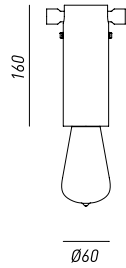

214.03.FF
214.03.ON
214.03.OO
1x Max 57W E27 

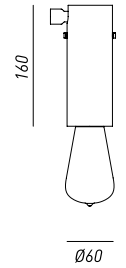

214.13.FF
214.13.ON
214.13.OO
1x Max 57W E27 

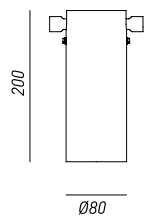

214.02.FF
214.02.ON
214.02.OO
1x Max 50W E27 PAR20 

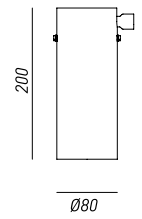

214.12.FF
214.12.ON
214.12.OO
1x Max 50W E27 PAR20 

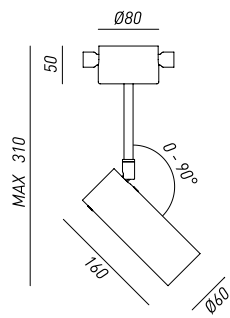

214.07.FF
214.07.ON
214.07.OO
1x Max 35W GU10

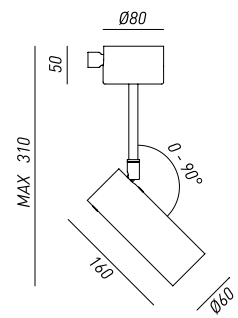

214.17.FF
214.17.ON
214.17.OO
1x Max 35W GU10

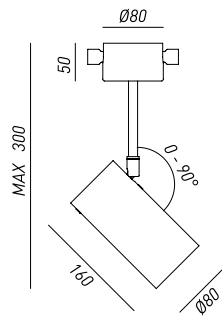

214.05.FF
214.05.ON
214.05.OO
1x Max 50W E27 PAR20

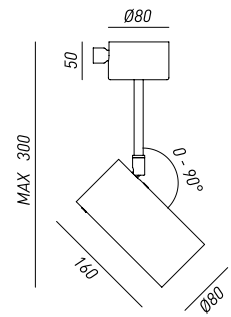

214.15.FF
214.15.ON
214.15.OO
1x Max 50W E27 PAR20

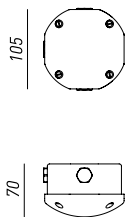

200.01.00
200.01.ON
 Scatola di derivazione - 4 fori entrata
 Connector block - 4 access holes

FORNITA CON 3 TAPPI 200.05.00
 SUPPLIED WITH 3 SCREW TOPS 200.05.00
 IP 40

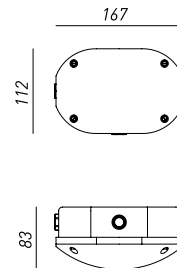

200.02.00
200.02.ON
 Scatola di derivazione - 4 fori entrata
 Connector block - 4 access holes

FORNITA CON 3 TAPPI 200.05.00
 SUPPLIED WITH 3 SCREW TOPS 200.05.00
 IP 40

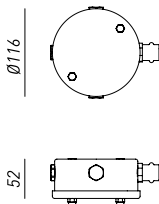

200.55.00
200.55.ON
200.55.FF
 Scatola di derivazione - 4 fori entrata
 Connector block - 4 access holes

FORNITA CON 3 TAPPI 200.05.00
 E 1 ATTACCO 1/2" 200.28.00
 SUPPLIED WITH 3 SCREW TOPS 200.05.00
 AND 1 1/2" CONNECTION 200.28.00
 IP 40

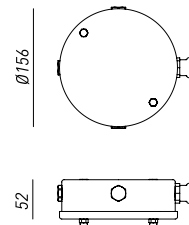

200.56.00
200.56.ON
200.56.FF
 Scatola di derivazione - 4 fori entrata
 Connector block - 4 access holes

FORNITA CON 3 TAPPI 200.05.00
 E 1 ATTACCO 1/2" 200.28.00
 SUPPLIED WITH 3 SCREW TOPS 200.05.00
 AND 1 1/2" CONNECTION 200.28.00
 IP 40

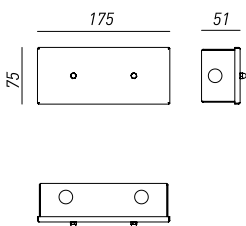

200.32.00
200.32.ON
 Scatola di derivazione - 6 fori entrata
 Connector block - 6 access holes

FORNITA SENZA TAPPI
 E ATTACCHI 1/2"
 SUPPLIED WITHOUT SCREW TOPS
 AND 1/2" CONNECTIONS
 IP 40

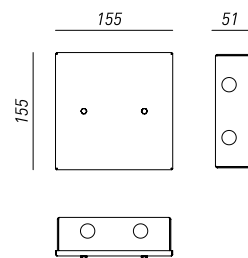

200.33.00
200.33.ON
 Scatola di derivazione - 8 fori entrata
 Connector block - 8 access holes

FORNITA SENZA TAPPI
 E ATTACCHI 1/2"
 SUPPLIED WITHOUT SCREW TOPS
 AND 1/2" CONNECTIONS
 IP 40

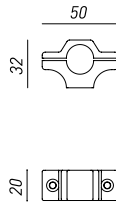

200.04.00
200.04.0N
Supporto a muro per tubo Ø 18 mm
Piping wall support Ø 18 mm

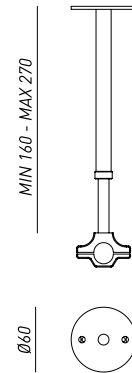

200.39.01
200.39.N1
Supporto a soffitto per tubo Ø 18 mm
Piping wall support Ø 18 mm



200.05.00
200.05.0N
Tappo 1/2"
1/2" Plug

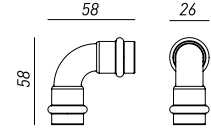

200.07.RR
200.07.ON
Curva 90° per tubo Ø 18 mm
Piping 90° elbow Ø 18 mm

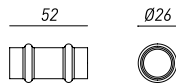

200.09.RR
200.09.ON
Manicotto per tubo Ø 18 mm
Pipe coupling Ø 18 mm

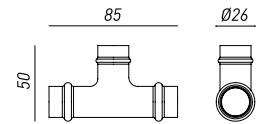

200.11.RR
200.11.ON
Raccordo a T per tubo Ø 18 mm
Piping union tee Ø 18 mm

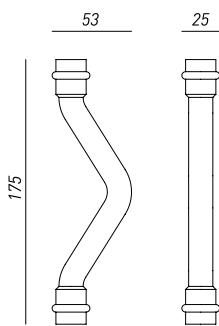

200.13.ON
200.13.RR
 Sorpasso per tubo Ø 18 mm
 Piping overrunning Ø 18 mm

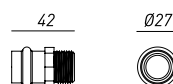

200.28.ON
200.28.OO
 Attacco 1/2" per tubo Ø 18 mm
 1/2" pipe connection for pipe Ø 18 mm

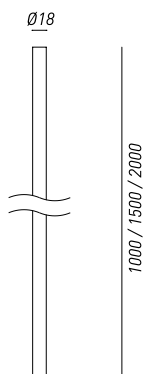

200.31.100 H 100
200.31.10N H 100
200.31.150 H 150
200.31.15N H 150
200.31.200 H 200
200.31.20N H 200
 Tubo liscio Ø 18 mm
 Smooth pipe Ø 18 mm

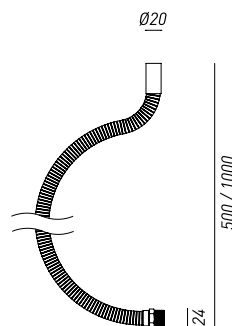

200.53.050 H 50
200.53.05N H 50
200.53.100 H 100
200.53.10N H 100
 Tubo flessibile con attacco scatola e manicotto
 per tubo Ø 18 mm
 Pliant pipe with box connection and coupling
 for pipe Ø 18 mm

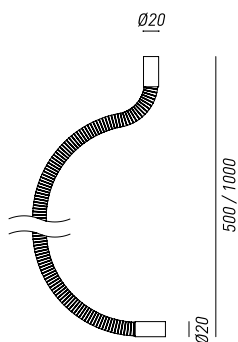

200.54.050 H 50
200.54.05N H 50
200.54.100 H 100
200.54.10N H 100
 Tubo flessibile con due manicotti per tubo Ø 18 mm
 Pliant pipe with 2 coupling for pipe Ø 18 mm

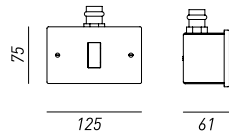

200.35.01
200.35.N1
 Scatola 1 Frutto c/2 fori completa di 1 tappo **200.05.00** e 1 attacco 1/2"
200.28.00 per interruttore BTICINO MAGIC (non fornito)
 1 way box w/2 holes with 1 screw top **200.05.00** and 1 1/2" connection
200.28.00 for BTICINO MAGIC (not supplied)
 IP 40

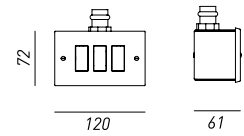

200.35.03
200.35.N3
 Scatola 1 Frutto c/2 fori completa di 1 tappo **200.05.00** e 1 attacco 1/2"
200.28.00 per interruttore BTICINO MAGIC (non fornito)
 1 way box w/2 holes with 1 screw top **200.05.00** and 1 1/2" connection
200.28.00 for BTICINO MAGIC (not supplied)
 IP 40

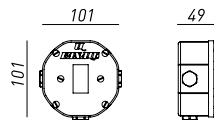

200.51.0N
200.51.00
 Scatola 1 Frutto c/4 fori completa di 3 tappi **200.05.00** per interruttore
 BTICINO MAGIC (non fornito).
 1 way box w/4 holes complete with 3 screw tops **200.05.00** for BTICINO MAGIC
 switch (not supplied).
 IP 40

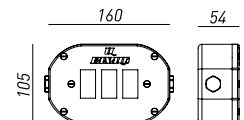

200.52.0N
200.52.00
 Scatola 3 Frutti c/4 fori completa di 3 tappi **200.05.00** per interruttore
 BTICINO MAGIC (non fornito).
 3 way box w/4 holes complete with 3 screw tops **200.05.00** for BTICINO
 MAGICswitch (not supplied).
 IP 40

optional

PER SOSPENSIONI DA ESTERNO
FOR OUTDOOR SUSPENSION LAMPS

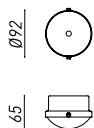

300.37.R1
Basetta 1 entrata per tubo Ø 18 mm
Terminal strip 1 input for piping Ø 18 mm
IP 44

PER SOSPENSIONI DA ESTERNO
FOR OUTDOOR SUSPENSION LAMPS

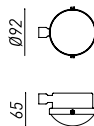

300.34.R1
Basetta 1 entrata per tubo Ø 18 mm
Terminal strip 1 input for piping Ø 18 mm
IP 44

PER SOSPENSIONI DA ESTERNO
FOR OUTDOOR SUSPENSION LAMPS

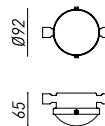

300.36.R1
Basetta 1 entrata per tubo Ø 18 mm
Terminal strip 1 input for piping Ø 18 mm
IP 44

PER / FOR: 247.01/02/03.00_247.21/22/23.00_247.31/32/33.00

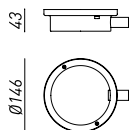

300.30.R1
Controbase 1 entrata per tubo Ø 18 mm
Counterbase 1 input for piping Ø 18 mm

PER / FOR: 247.01/02/03.00_247.21/22/23.00_247.31/32/33.00

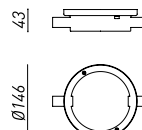

300.32.R2
Controbase 2 entrate per tubo Ø 18 mm
Counterbase 2 inputs for piping Ø 18 mm

ACCESSORI BASI AD ANGOLO PER TUTTI GLI APPLIQUES / ANGLE BASE ACCESSORIES FOR ALL APPLIQUES

accessori base angolo / angle base accessories

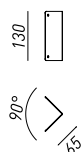

300.03.00
Per basi fino a 150 mm
For bases up to 150 mm

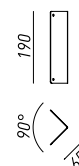

300.04.00
Per basi fino a 250 mm
For bases up to 250 mm

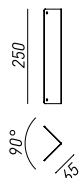

300.05.00
Per basi fino a 350 mm
For bases up to 350 mm

esempio / example



RILEGATO

L'ISPIRAZIONE A FORME GEOMETRICHE PURE E L'ANTICA TRADIZIONE DELLA RILEGATURA A PIOMBO FANNO DELLE LAMPADE DELLA COLLEZIONE RILEGATO DEI VERI E PROPRI SIMBOLI DELLA TRADIZIONE ARTIGIANA ITALIANA E AL CONTEMPO DEI PRODOTTI MODERNI IN GRADO DI ADATTARSI AI CONTESTI INTERNAZIONALI. PRODOTTI UNICI ED ESCLUSIVI, INTERAMENTE FATTI A MANO E REALIZZATI CON VETRO BISELLATO E BASE INTERNA IN OTTONE, DISPONIBILI NELLE FINITURE CROMO, ORO E BRUNITO.

THE LAMPS OF THE RILEGATO COLLECTION, INSPIRED BY GEOMETRIC SHAPES AND THE OLD TRADITION OF LEAD RIMS, ARE A TRUE SYMBOL OF THE ITALIAN ARTISAN HERITAGE. YET, AT THE SAME TIME, THEY ARE MODERN AND SUITABLE FOR ANY INTERNATIONAL CONTEXT. THESE UNIQUE AND EXCLUSIVE PRODUCTS ARE ENTIRELY HANDMADE WITH BEVELED GLASS AND INTERNAL BRASS BASES AND ARE AVAILABLE IN CHROME, GOLD, AND BURNISHED FINISHES.



lampade / lamps



MEDINA DP
LED 7W 3000K
MEDINA DPE
1x Max 57W E27 

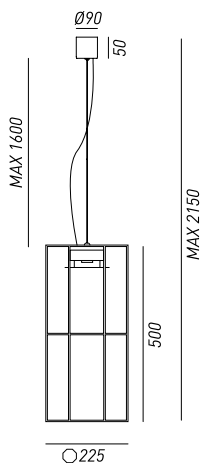

MEDINA TC
LED 7W 3000K
MEDINA TCE
1x Max 57W E27 

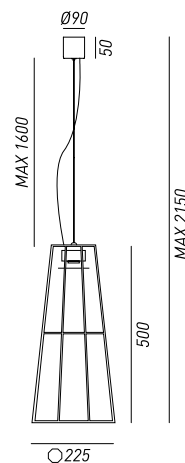

MEDINA O
LED 7W 3000K
MEDINA OE
1x Max 57W E27 

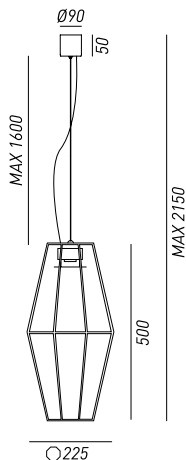

dettaglio rosoni / canopie's details



MEDINA DP-TC-O
Ø 90 mm H 50 mm

finiture montatura / frame finishes



OTTONE BRUNITO
BURNISHED BRASS

vetro / glass



VETRO TRASPARENTE
TRANSPARENT GLASS



502.00.64



502.00.80

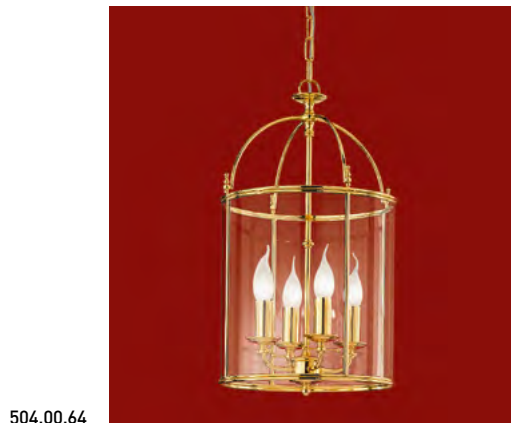

504.00.64



504.00.80



506.00.64



506.00.80

finiture montatura / frame finishes



OTTONE DORATO
GOLDEN BRASS



OTTONE CROMATO
CHROME BRASS



OTTONE BRUNITO
BURNISHED BRASS

vetro / glass



VETRO TRASPARENTE
TRANSPARENT GLASS

lampade / lamps

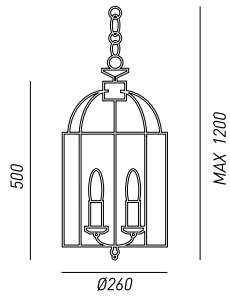

502.00.62
2 x Max 46W E14

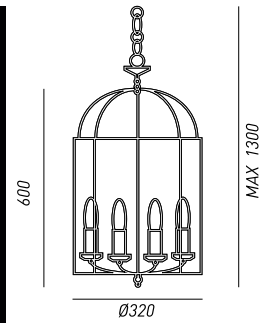

504.00.62
4 x Max 46W E14

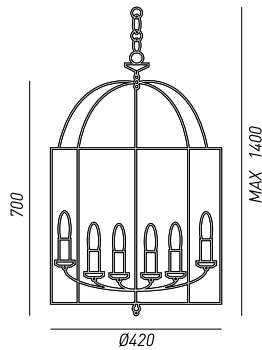

506.00.62
6 x Max 46W E14

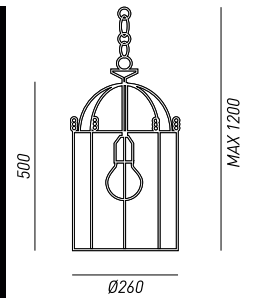

509.00.62
1 x Max 57W E27

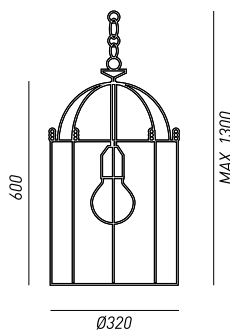

510.00.62
1 x Max 57W E27

dettaglio rosone / canopie's details



Ø 90 mm H 55 mm
Rosone standard per tutte le montature
Standard canopy for all frames



503.00.64



503.00.80



505.00.64



505.00.80



509.00.64



509.00.80



510.00.64



510.00.80

finiture montatura / frame finishes



OTTONE DORATO
GOLDEN BRASS



OTTONE BRUNITO
BURNISHED BRASS

vetro / glass



VETRO TRASPARENTE
TRANSPARENT GLASS



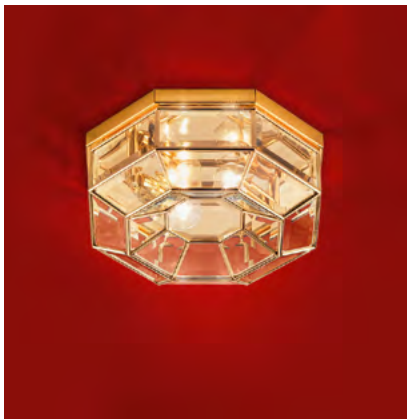

379.00.64



379.00.80



380.00.64



380.00.80



402.00.64



402.00.80



401.00.64



401.00.80



lampade / lamps

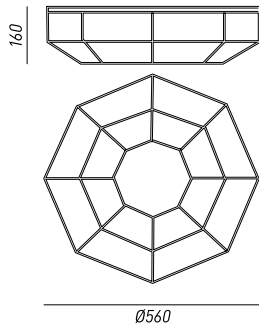

380.00.62
4 x Max 46W E27

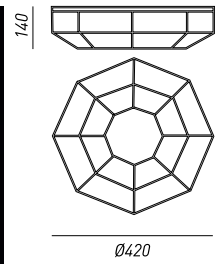
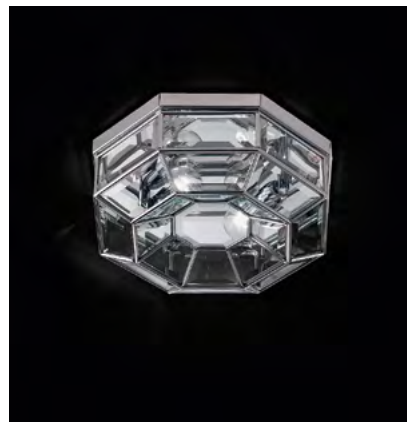

379.00.62
4 x Max 30W E27

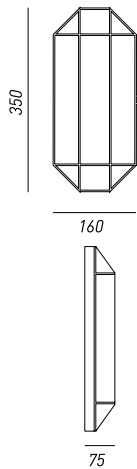

401.00.62
2 x Max 28W E14

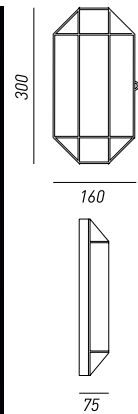

402.00.62
1 x Max 46W E14

finiture montatura / frame finishes



OTTONE DORATO
GOLDEN BRASS



OTTONE CROMATO
CHROME BRASS



OTTONE BRUNITO
BURNISHED BRASS

vetro / glass



VETRO TRASPARENTE
TRANSPARENT GLASS



413.00.64



413.00.80





410.00.64



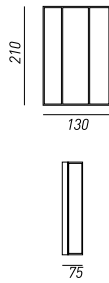

410.00.80

lampade / lamps

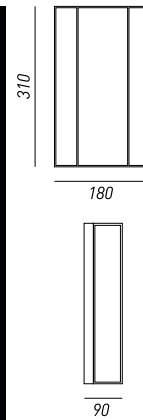

413.00.62
1 x Max 46W E14 



410.00.62
2 x Max 28W E14 

finiture montatura / frame finishes



OTTONE DORATO
GOLDEN BRASS



OTTONE CROMATO
CHROME BRASS



OTTONE BRUNITO
BURNISHED BRASS

vetro / glass



VETRO TRASPARENTE
TRANSPARENT GLASS





492.00.64

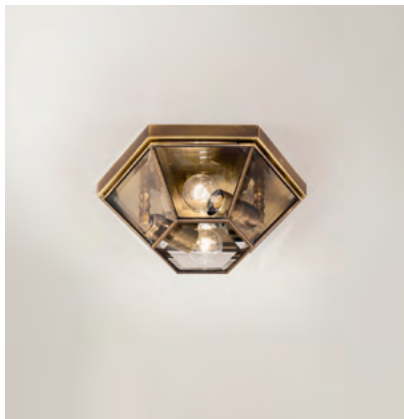

492.00.80



491.00.64



491.00.80



490.00.64



490.00.80



461.00.64



461.00.80

lampade / lamps

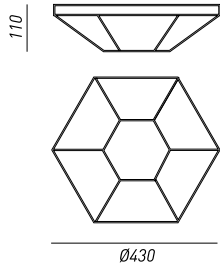

490.00.62
2 x Max 46W E27

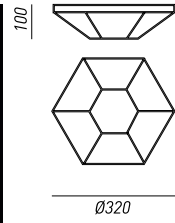

491.00.62
2 x Max 46W E14

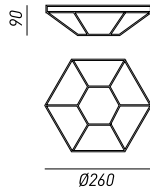
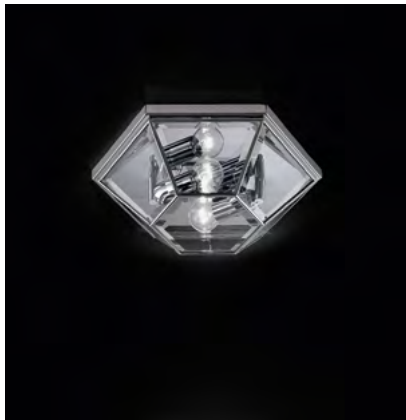

492.00.62
2 x Max 30W E14

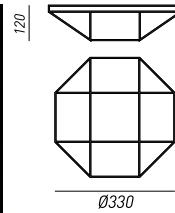

461.00.62
2 x Max 46W E14



477.00.64



476.00.80



476.00.64



476.00.80

lampade / lamps

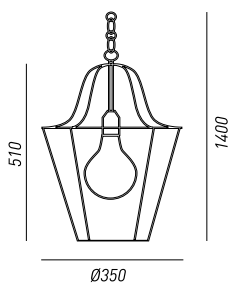

476.00.62
1 x Max 77W E27

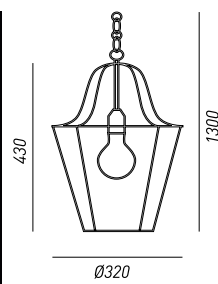

477.00.62
1 x Max 77W E27

dettaglio rosoni / canopies details



Ø 90 mm H 55 mm
Rosone standard per tutte le montature
Standard canopy for all frames

finiture montatura / frame finishes



OTTONE DORATO
GOLDEN BRASS



OTTONE CROMATO
CHROME BRASS



OTTONE BRUNITO
BURNISHED BRASS

vetro / glass



VETRO TRASPARENTE
TRANSPARENT GLASS

COMPANY

UNA STORIA FATTA DI LUCE E PASSIONE.

ALLA BASE DI QUELLA CHE OGGI È UN'AZIENDA CHE RAPPRESENTA NEL MONDO L'ARTIGIANALITÀ E IL MADE IN ITALY C'È LA FAMIGLIA: PERSONE, COLLABORATORI E DIPENDENTI CON GLI STESSI IDEALI GUIDATI DALLA PASSIONE PER IL LAVORO, LA DEDIZIONE E UN DIALOGO APERTO CON L'AZIENDA E VERSO CHI CI LAVORA. IL SUCCESSO DE IL FANALE OGGI È DOVUTO ALLA SOMMA DELLE RISORSE CHE FANNO PARTE DELL'AZIENDA.

DIETRO IL PRODOTTO CI SONO LE PERSONE.

CHI LAVORA OGGI NELL'AZIENDA SA CHE È PARTE DI UNA STORIA CHE SI SCRIVE GIORNO DOPO GIORNO, NATA TRENTACINQUE ANNI FA E CHE RAPPRESENTA NEL MONDO LA TRADIZIONE E L'ARTIGIANALITÀ ITALIANA. OGGI L'AZIENDA È GUIDATA DA FAUSTO DALLA TORRE E LUISA MARTIN, AFFIANCATI DAI LORO FIGLI MARZIA E TOMAS.

FILOSOFIA AZIENDALE.

VISION - L'AZIENDA SI CONCENTRA SULLA CREAZIONE DI PRODOTTI NEL SETTORE DELL'ILLUMINAZIONE DI DESIGN MANTENENDO SEMPRE ATTENTA LA RICERCA TECNICA E MATERICA. I RISULTATI FINORA OTTENUTI HANNO INCORAGGIATO L'AZIENDA A CONTINUARE E SEGUIRE QUESTO APPROCCIO AL FINE DI PORTARE IL FANALE GROUP A ESSERE SEMPRE PIÙ RICONOSCIUTO E RICONOSCIBILE NEL MONDO COME ICONA DI ARTIGIANALITÀ E MADE IN ITALY. L'OBIETTIVO È QUELLO DI OFFRIRE UNA GAMMA DI PRODOTTI DI ALTA QUALITÀ SENZA MAI PERDERE DI VISTA I CRITERI TECNICI, ESTETICI E FUNZIONALI CHE LI CARATTERIZZANO.
MISSION - L'AZIENDA SI PROPONE DI RAGGIUNGERE GRANDI OBIETTIVI CONTINUANDO PARALLELAMENTE A COLTIVARE LA PASSIONE PER LA LUCE E PER IL DESIGN. LA MISSIONE È QUELLA DI AVERE L'OPPORTUNITÀ E LA RESPONSABILITÀ DI FORNIRE PRODOTTI, CHE NON SI LIMITINO A SODDISFARE LE ESIGENZE DEI SINGOLI, MA CHE RACCONTINO UNA STORIA ALLE PERSONE E ALL'AMBIENTE CHE ANDRANNO A CARATTERIZZARE CON LE PROPRIE PECULIARITÀ.

L'ATTITUDINE PER LE COLLABORAZIONI CON PROGETTISTI E ARCHITETTI APPARTENENTE ALLA FILOSOFIA DELL'AZIENDA RENDE POSSIBILE OGNI GIORNO LA REALIZZAZIONE DI PROGETTI INTERNAZIONALI PER LE PIÙ DIVERSE AMBIENTAZIONI.



A STORY OF LIGHT AND PASSION.

AT THE BASE OF WHAT IS NOW A COMPANY THAT REPRESENTS THE CRAFTSMANSHIP AND MADE IN ITALY IN THE WORLD IS THE FAMILY: PEOPLE, PARTNERS AND EMPLOYEES WITH THE SAME IDEALS DRIVEN BY PASSION FOR WORK, DEDICATION AND AN OPEN DIALOGUE WITH THE COMPANY AND WITH THOSE WHO WORK THERE. THE SUCCESS OF IL FANALE GROUP IS DUE TO THE AMOUNT OF RESOURCES THAT ARE PART OF THE COMPANY.

BEHIND THE PRODUCT THERE ARE PEOPLE.

THOSE WHO WORK TODAY IN THE COMPANY KNOW THAT THEY ARE A PART OF A STORY THAT IS BEING WRITTEN EVERY DAY, BORN THIRTY FIVE YEARS AGO AND THAT REPRESENTS THE TRADITION AND ITALIAN CRAFTSMANSHIP IN THE WORLD. TODAY THE COMPANY IS LED BY FAUSTO DALLA TORRE AND LUISA MARTIN, ACCOMPANIED BY THEIR CHILDREN MARZIA AND TOMAS.

BUSINESS PHILOSOPHY

VISION - THE COMPANY FOCUSES ON CREATING PRODUCTS IN THE FIELD OF LIGHTING DESIGN WHILE MAINTAINING CAREFUL TECHNICAL AND MATERIAL RESEARCH. THE RESULTS OBTAINED SO FAR HAVE ENCOURAGED THE COMPANY TO CONTINUE AND FOLLOW THIS APPROACH IN ORDER TO BRING IL FANALE GROUP TO BE MORE AND MORE RECOGNIZED AND RECOGNIZABLE IN THE WORLD AS AN IMAGE OF CRAFTSMANSHIP AND MADE IN ITALY. THE GOAL IS TO OFFER A RANGE OF HIGH QUALITY PRODUCTS WITHOUT EVER LOSING SIGHT OF THE TECHNICAL, AESTHETIC AND FUNCTIONAL CRITERIA THAT CHARACTERIZE THEM.

MISSION - THE COMPANY SETS OUT TO ACHIEVE GREAT OBJECTIVES WHILE CONTINUING TO NURTURE PASSION FOR THE LIGHT AND DESIGN. THE MISSION IS TO HAVE THE OPPORTUNITY AND RESPONSIBILITY TO PROVIDE PRODUCTS THAT NOT ONLY MEET THE NEEDS OF THE INDIVIDUALS, BUT THAT TELL A STORY TO PEOPLE AND WORLD THAT WILL BE CHARACTERIZED BY ITS OWN PECULIARITIES.

THE ATTITUDE TO COLLABORATION WITH DESIGNERS AND ARCHITECTS BELONGING TO THE COMPANY'S PHILOSOPHY MAKES THE DAILY INTERNATIONAL PROJECTS FOR MANY DIFFERENT ENVIRONMENTS POSSIBLE.



FOTO SCATTATA NEL 2010 / PICTURE TAKEN IN 2010

MANUFACTURING

LE NOSTRE LAMPADE SONO OPERE "DI ARTE E DI LUCE", IN GRADO DI INSERIRSI IN CONTESTI CONTEMPORANEI COME RICHIAMI ALLA TRADIZIONE ITALIANA.

ABBIAMO FATTO DEL MADE IN ITALY IL NOSTRO SEGNO DISTINTIVO.

LA PRODUZIONE, INTERAMENTE ITALIANA, È IN GRADO DI FONDERE ALLA PERFEZIONE UN SUBLIME ARTIGIANATO CON LE PIÙ RECENTI TECNICHE D'ILLUMINAZIONE DANDO VITA COSÌ A PRODOTTI UNICI E SENZA TEMPO, MANTENENDO INALTERATA LA MATERIA PRIMA.

IL DESIGN DI OGNI COLLEZIONE SI CONFIGURA COME SINTESI PERFETTA DI FORMA E FUNZIONE CHE, UNITO A UN'ELEVATA QUALITÀ DEI MATERIALI E UNA PREMUROSA LAVORAZIONE RENDE OGNI PRODUZIONE UNICA E NON STANDARDIZZATA: UN'EDIZIONE SPECIALE.

IL FANALE PROPONE PRODOTTI CARATTERIZZATI DA UN ALTO CONTENUTO PROGETTUALE RIVOLGENDOSI A UN PUBBLICO CHE ABBIA UNO STILE PERSONALE E RICERCATO, SENZA PERÒ TRASCURARE LE PIÙ ATTUALI TENDENZE.

LE LINEE SEMPLICI, PULITE ED ELEGANTI CON CONTAMINAZIONI INTERNAZIONALI SI INTEGRANO E RISPETTANO LA MANUALITÀ ARTIGIANA ITALIANA DANDO VITA A LAMPADE CONTRADDISTINTE DA UN EQUILIBRIO DI VOLUMI E PROPORZIONI E UNA CREATIVITÀ SENZA ECCESSI CHE RISALTA IL VALORE APPARTENENTE AL PRODOTTO. UN VALORE RACCONTATO ATTRAVERSO LE SAPIENTI MANI DEI NOSTRI ARTIGIANI CHE GRAZIE ALL'UTILIZZO DI MATERIALI DI QUALITÀ E UNA FORTE ATTENZIONE ALLE TECNICHE PRODUTTIVE CONFERISCE VALORE AGGIUNTO A PRODOTTI "SARTORIALI".

CI PIACE DEFINIRCI COME "SCULTORI DELLA LUCE". E' PROPRIO PARTENDO DA QUESTO PRESUPPOSTO CHE PLASMIAMO LA MATERIA E DIAMO FORMA ALLE EMOZIONI CREANDO PEZZI UNICI: PRODOTTI PERSONALIZZATI E FATTI SU MISURA PER I NOSTRI PROGETTI D'ARREDO.

TEAM IL FANALE

MATERIALI

I MATERIALI UTILIZZATI PER LA REALIZZAZIONE DI TUTTE LE LAMPADE IL FANALE, SONO QUELLI PIÙ RAPPRESENTATIVI DELLA TRADIZIONE: OTTONE, RAME, FERRO.

I VETRI DI MURANO E LE CERAMICHE DI BASSANO RAPPRESENTANO INVECE LE PIÙ ALTE ESPRESSIONI DEL MADE IN ITALY. I METALLI CON I QUALI REALIZZIAMO LE NOSTRE LAMPADE, SONO SOTTOPOSTI AD UN PARTICOLARE TRATTAMENTO DI OSSIDAZIONE ACCELERATA CHE CONFERISCE UNA PATINA D'INVECCHIAMENTO, CHE NOI DEFINIAMO "ANTICATO".

I TRATTAMENTI POST LAVORAZIONE E LE PROCEDURE CHE VENGONO UTILIZZATE PER GIUNGERE AL PRODOTTO FINALE RISPETTANO METODI ARTIGIANALI E TRADIZIONALI APPARTENENTI ALLA FAMIGLIA E TRAMANDATI FINO AD OGGI.

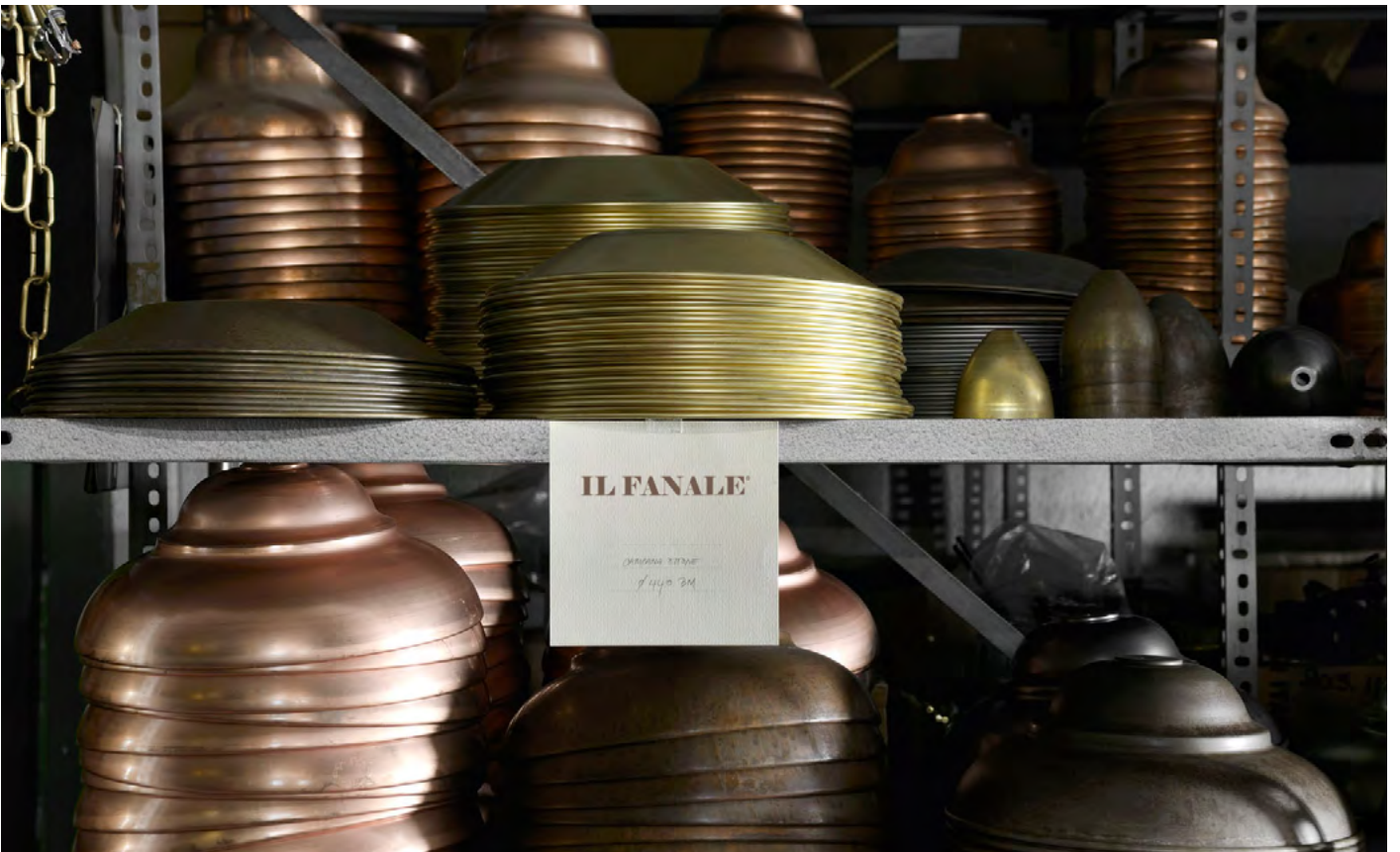

OUR LAMPS ARE WORKS "OF ART AND LIGHT" THAT CAN ENTER THE CONTEMPORARY CONTEXTS AS REFERENCES TO THE ITALIAN TRADITION.

THE MADE IN ITALY IS OUR HALLMARK.

THE PRODUCTION, BEING ENTIRELY ITALIAN, IS ABLE TO JOIN TO PERFECTION SUBLIME HANDICRAFTS WITH THE LATEST ILLUMINATION TECHNIQUES THUS GIVING LIFE TO UNIQUE AND TIMELESS PRODUCTS, WHILE MAINTAINING THE RAW MATERIAL UNCHANGED.

THE DESIGN OF EACH COLLECTION IS THE PERFECT SYNTHESIS OF FORM AND FUNCTION WHICH, COMBINED WITH HIGH QUALITY MATERIALS AND A THOUGHTFUL PROCESS MAKES EACH UNIQUE AND UNCONVENTIONAL PRODUCTION: A SPECIAL EDITION.

IL FANALE GROUP OFFERS PRODUCTS WITH A HIGH DESIGN CONTENT APPEALING TO AN AUDIENCE THAT HAS A PERSONAL AND SOPHISTICATED STYLE, WITHOUT NEGLECTING THE LATEST TRENDS.

THE SIMPLE, CLEAN AND ELEGANT LINES WITH INTERNATIONAL INFLUENCES, COMPLEMENT AND RESPECT THE ITALIAN MANUAL HANDCRAFTS, CREATING LAMPS DISTINGUISHED BY THE BALANCE OF VOLUMES AND PROPORTIONS AND THE CREATIVITY WITHOUT THE EXCESSIVENESS THAT BRINGS TO THE FORE THE VALUE OF THE PRODUCT. A VALUE TOLD BY THE SKILLED HANDS OF OUR CRAFTSMEN WITH THE USE OF QUALITY MATERIALS AND A STRONG FOCUS ON PRODUCTION TECHNIQUES CONFERS AN ADDITIONAL VALUE TO "SARTORIAL" PRODUCTS.

WE LIKE TO DEFINE OURSELVES AS "SCULPTORS OF LIGHT." AND 'PRECISELY FROM THIS ASSUMPTION THAT WE SHAPE THE MATTER AND GIVE SHAPE TO THE EMOTIONS, CREATING UNIQUE PIECES AND CUSTOM-MADE PRODUCTS TAILORED FOR OUR FURNITURE PROJECTS.
IL FANALE TEAM

THE MATERIALS

THE MATERIALS USED FOR THE PRODUCTION OF ALL IL FANALE LAMPS, ARE THOSE MOST REPRESENTATIVE OF THE TRADITION: **BRASS, COPPER, IRON.**

THE MURANO GLASS AND CERAMICS OF BASSANO REPRESENT ON THE OTHER HAND THE HIGHEST EXPRESSIONS OF MADE IN ITALY. THE METALS WE USE TO CREATE OUR LAMPS ARE SUBJECTED TO A SPECIAL TREATMENT OF ACCELERATED OXIDATION THAT GIVES A GLOSS OF AGING, WHICH WE REFER TO AS "ANTIQUE" LOOK.

THE POST-PROCESSING TREATMENTS AND PROCEDURES THAT ARE USED TO REACH THE FINAL PRODUCT COMPLY WITH TRADITIONAL METHODS BELONGING TO THE FAMILY AND PASSED ON UNTIL NOW.

PROJECTS

VUOI CHE I TUOI PROGETTI VENGANO PUBBLICATI?
SPEDISCI LE FOTO A MARKETING@ILFANALE.COM

WANT TO GET YOUR PROJECTS FEATURED?
SEND YOUR PICTURES TO MARKETING@ILFANALE.COM

ABBIAMO DATO FORMA A GRANDI PROGETTI DI DESIGN IN TUTTO IL MONDO.

IL FANALE SOSTIENE LO SVILUPPO DI GRANDI PROGETTI NEL MONDO REALIZZATI GRAZIE A COLLABORAZIONI CON ARCHITETTI E PROGETTISTI DI FAMA INTERNAZIONALE. UN NETWORK CHE RIUNISCE PROFESSIONISTI E "ARTISTI" CON LO SCOPO DI ILLUMINARE SPAZI PRIVATI E AMBIENTI URBANI NEL MONDO CON LA GARANZIA DEL MARCHIO IL FANALE. LA NOSTRA ESPERIENZA NEL SETTORE CI PERMETTE DI SUPERARE OSTACOLI TECNICI E FORNIRE SOLUZIONI PERSONALIZZATE AL FINE DI SODDISFARE LE ESIGENZE DI OGNI SINGOLA REALIZZAZIONE. OGNI PROGETTO È CARATTERIZZATO DALLA PERFETTA FUSIONE TRA LIGHTING DESIGN E ARTIGIANALITÀ. OGGI IL FANALE È UN AZIENDA CONOSCIUTA IN TUTTO IL MONDO PER LE SUE LAMPADE DI QUALITÀ E RAPPRESENTATIVE DEL MADE IN ITALY.

WE HAVE CREATED MAJOR DESIGN PROJECTS AROUND THE WORLD.

IL FANALE SUPPORTS THE DEVELOPMENT OF MAJOR PROJECTS IN THE WORLD ACHIEVED THROUGH COLLABORATIONS WITH ARCHITECTS AND DESIGNERS OF INTERNATIONAL FAME. A NETWORK THAT GETS TOGETHER PROFESSIONALS AND "ARTISTS" WITH THE GOAL OF ILLUMINATING PRIVATE SPACES AND URBAN SURROUNDINGS IN THE WORLD WITH THE GUARANTEE OF THE BRAND IL FANALE. OUR EXPERIENCE ALLOWS US TO OVERCOME TECHNICAL BARRIERS AND PROVIDE CUSTOMIZED SOLUTIONS TO MEET THE NEEDS OF EVERY SINGLE PRODUCTION. EACH PROJECT IS CHARACTERIZED BY THE PERFECT BLEND OF LIGHTING DESIGN AND CRAFTSMANSHIP. TODAY, IL FANALE IS A COMPANY KNOWN ALL OVER THE WORLD FOR ITS QUALITY LAMPS AND THE MADE IN ITALY LOGO.



BARRACA RODIZO Grill & Bar HOLLAND



SEMELI WINERY GREECE



BUENA VISTA HOTEL AUSTRALIA



THE LAMB SHOP AUSTRALIA



GESTO ITALY



AGRITURISMO LOGHINO BELSITO ITALY



CRINITI'S AUSTRALIA



GOODY'S BURGER HOUSE GREECE



RESIDENTIAL USA



THE CARRIAGE ROOMS NORTHERN IRELAND



WERSENS SWEDEN

Barraca Rodizo Grill & Bar / HOLLAND
Photo credits: Barraca Rodizo Grill & Bar



Semeli Winery / GREECE
Photo credits: Semeli Winery



Buena Vista Hotel / AUSTRALIA

Project by SJB Interiors in collaboration with Tess Regan Design / Photo credits: Felix Forest / Images courtesy of: LightCo









The Lamb Shop / AUSTRALIA

Project by LightWorks / Photo credits: LightCo

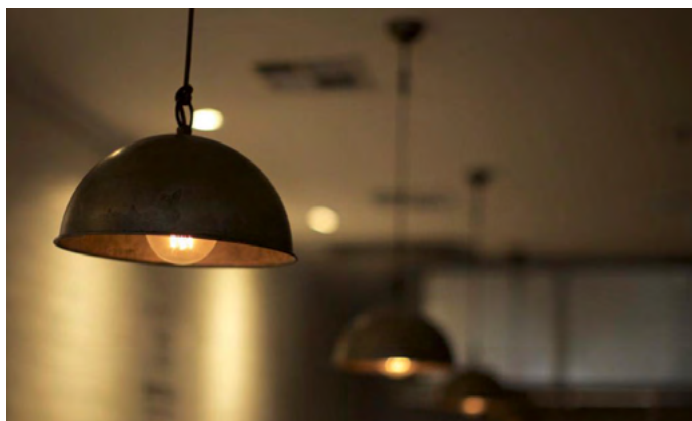
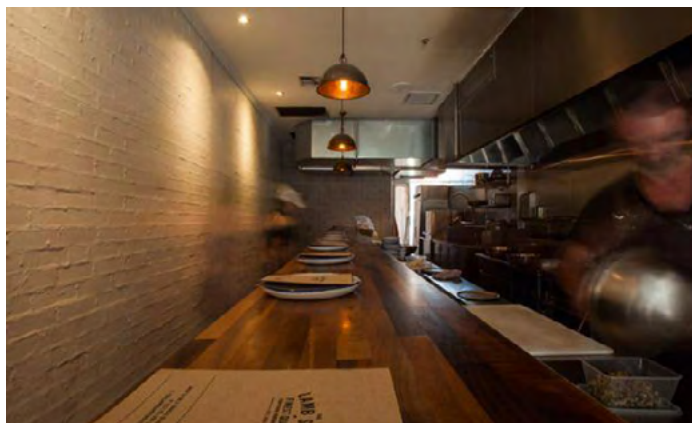

Gesto / ITALY

Photo credits: Gesto Firenze





CAFFETERIA

- Espresso 1
- Caffè americano 1
- Caffè americano speziato 1,5
- Macchiato 1
- Latte macchiato 1,5
- Latte 1,5
- Latte con panna 1,5

BEVERAGE

- Acqua (0,50) 1
- Succhi di frutta 2,5
- Birra chiara piccola / media 3 / 4,5
- Birra rossa piccola / media 3,5 / 5
- Gottoso di vino bianco / rosso 1
- Birre artigianali (0,33 / 0,75) 5 / 12

DRINK

- Spremuta 2,5
- Longdrink 5
- Pastati 6
- Frozen 5
- Amari 3
- Whisky 3
- Ice-tea 5
- Shot 2
- Grappe 3

VINI

- Bollicine
- Vini bianchi
- Vini rossi
- Vini dolci

**LA NOSTRA
È UNA SELEZIONE
DI VINI BIOLOGICI
E BIODINAMICI**

**UN GESTO
Semplice &
AUTENTICO**



Agriturismo Loghino Belsito / ITALY

Project by Vesperini Della Noce Designers / Photo credits: Fabio Cattabiani



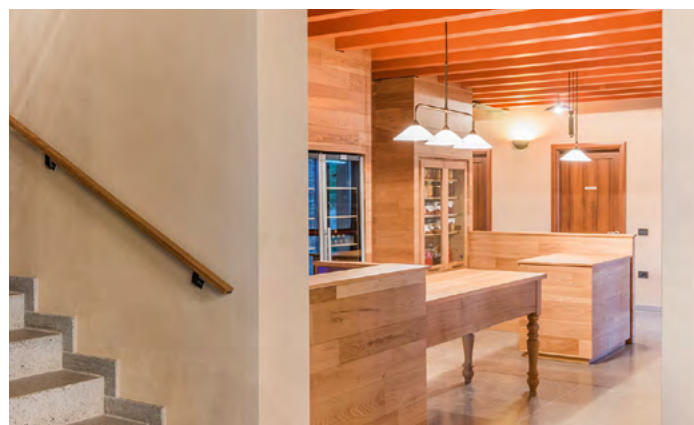
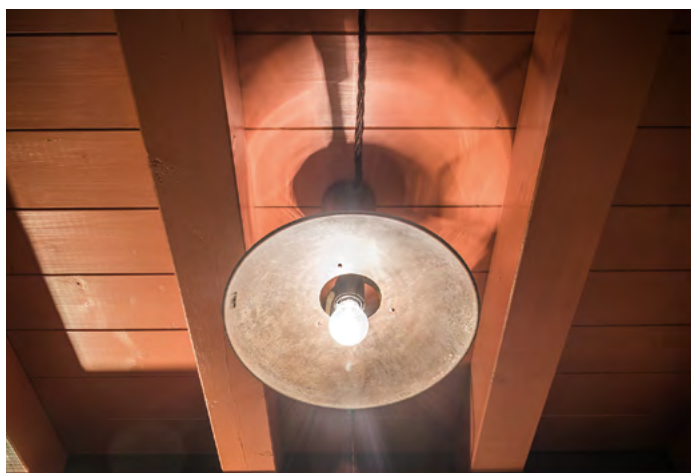

Criniti's / AUSTRALIA
Project by LightCo









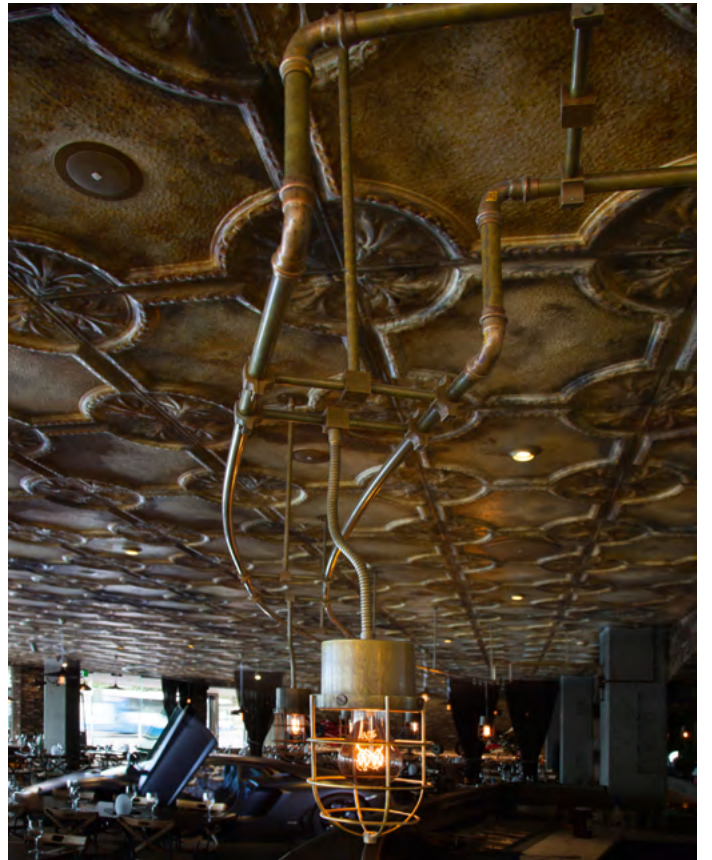



Goody's Burger House / GREECE
Project by Chadios+Associates Studio





Residential / USA
Project by Alison Kandler





The Carriage Rooms / NORTHERN IRELAND
Project by John J O'Connel Architects and DLight Concepts Limited





Wersens / SWEDEN

Wersens Brasserie, Bar and Restaurant







VECKANS TIPS
FÖRRÄT: GUBBRÖRA MED LIKEALLAD, KAVR
JÄMT SVART RÖNINGSSÅS MED OXSV
SÅS & PURE POTATISLÅKERAD MÅJ
RÖNINGSSÅS LONDON MED SKALDJURSRIS
SÅS & SURDEGSKRUTONGER
OSSO BULO PÅ MÄRGPÅ FRÅN FJÄLLBETE
GREMOLATA
SVAMPQUESADILLA MED TOMATSALLAD
DESSERT: CHOKLADKRÄM MED RÄRÖRDA



...NGI & KALLLÖJROM	95:-
...NSRAGU, TRATTKANTAREUSKARAKA ...OVA SAMT RÖDVINSSÄS	295:-
...SOTTO, TOMATVINAIGRETTE, BÖNOR,	269:-
...MED SAFFRANS RISOTTO &	159:-
... & GHILOYOGHURT	169:-
...LIGNON & BRYNT SMÖR	75:-



F.A.Q

ITA

Siete produttori?

L'intera produzione delle nostre lampade è interna all'azienda ed è realizzata artigianalmente.

Per i vetri di Murano e le ceramiche di Bassano, ci affidiamo a produttori specializzati esterni.

Producez anche lampade su Misura?

Sì, realizziamo lampade che non fanno parte del nostro catalogo ma che sono create per soddisfare particolari esigenze e/o per progetti e realizzazioni di determinati spazi.

Che materiali utilizzate per i vostri prodotti?

I materiali utilizzati per la realizzazione delle nostre lampade sono: ferro, ottone, rame vetro e ceramica.

Quali sono le vostre finiture?

Le finiture che utilizziamo sono: ottone anticato, ferro anticato, rame anticato, foglia oro, foglia argento e foglia rame.

E' possibile su richiesta scegliere una finitura diversa da quella presente sul catalogo.

Posso avere il cavo di una sospensione di un colore diverso?

Sì, i cavi sono disponibili in bianco e in marrone.

Le vostre lampade subiscono alterazioni nel tempo?

Sì, questi cambiamenti rappresentano una peculiarità dei nostri prodotti che subiscono un processo di ossidazione accelerata che continua poi naturalmente fino a raggiungere la sua completa maturazione. Il prodotto così subisce cambiamenti dovuti anche a fattori temporali e all'esposizione agli agenti atmosferici. Su richiesta, il processo di ossidazione può essere bloccato attraverso una specifica lavorazione.

Come si puliscono le vostre lampade?

Le nostre lampade possono essere spolverate, ma non lavate. Applicando infatti qualsiasi prodotto per la pulizia potreste rovinare la patina che le caratterizza.

Le vostre lampade sono complete di lampadine?

No, le lampade sono sprovviste di lampadine. Le immagini sul catalogo sono solo a scopo illustrativo. Per acquistarle rivolgetevi ai punti vendita di materiale elettrico.

Dove posso trovare tutti i dettagli tecnici?

Per i dettagli tecnici aggiornati invitiamo a seguire il nostro sito web: www.ilfanale.com

Come posso registrarmi come nuovo cliente?

Puoi registrarti come nostro cliente all'interno del sito web www.ilfanale.com, compilando il modulo all'interno dell'area riservata.

Il Fanale Group srl si riserva il diritto di sospendere la produzione in qualunque momento e senza preavviso di qualsiasi articolo e, ferme restando le caratteristiche dei modelli descritti, di apportare variazioni di prezzo, modifiche di parti e dettagli che per qualsiasi esigenza di carattere produttivo ritenesse opportuno.

Per qualsiasi controversia viene riconosciuta la competenza esclusiva dell'autorità giudiziaria di Treviso.

ENG

Are you a manufacturer?

We manufacture everything in house and by hand. We trust external experts for the production of Murano glass and Bassano ceramic.

Do you manufacture made-to-order lamps?

Yes, we do make made-to-order lamps that are not included in our catalogue but meet special needs and/or requirements for the design of particular spaces.

What materials do you use for your lamps?

The materials we use for our lamps range from iron to brass, copper, glass, and ceramic.

What finishes do you offer?

Our range of finishes includes: antiqued brass, antiqued iron, antiqued copper, gold leaf, silver leaf and copper leaf. Upon request, we provide different finishes from those listed in the catalogue.

Is it possible to have a different colored suspension cord?

Yes, cords are available in both brown and white.

Do your lamps change over time?

Yes, changes in our products represent a unique feature of our lamps that undergo an accelerated oxidation process that continues naturally until it has reached its complete maturation. Our lamps can also be affected by time and weather conditions. Upon request, the oxidation process can be stopped through a special treatment with a transparent varnish.

What is the best way to clean your lamps?

Our lamps can be dusted, but not washed. Applying any type of cleaning product can, in fact, ruin the characteristic patina.

Do your lamps come with light bulbs?

No, our lamps do not come with light bulbs. Those shown in the catalogue are for illustrative purposes only. You must go to your nearest electrical equipment store to purchase them.

Where can I find all of the technical information?

For all updated technical information please visit our website: www.ilfanale.com.

How can I register as a new client?

You can register as a client on our website www.ilfanale.com by filling out the form in the reserved client area.

Il Fanale Group srl reserves the right to suspend any product from the production range without notification. Moreover it reserves the right to make any change (prices, technical details) without prior notice, maintaining the essential characteristics of the article should the need arise for its improvement.

Any disputes arising out of these terms of sale shall be exclusively settled by the court of Treviso, Italy.

Il Fanale Group srl

Via Bredariol 15

31048 San Biagio di Callalta (TV) Italy

Tel. +39 0422 895200

Fax +39 0422 895110

info@ilfanale.com

www.ilfanale.com

Credits

Concept: Il Fanale Group srl & Varianti srl unip.

Photography and colour separation: varianti.it

Copyright: Il Fanale Group srl & Varianti srl unip.

Printed by: Grafiche Antiga

2017

